

Contents

1 Introduction	3
2 How to Programme	5
Local Control Panel	5
How to operate graphical LCP (GLCP)	5
Quick Menu Mode	13
Function Setups	16
Main Menu Mode	19
3 Parameter Description	23
Parameter Selection	23
Main Menu - Operation and Display - Group 0	23
Main Menu - Load and Motor - Group 1	39
Main Menu - Brakes - Group 2	50
Main Menu - Reference/Ramps - Group 3	52
Main Menu - Limits/Warnings - Group 4	60
Main Menu - Digital In/Out - Group 5	65
Main Menu - Analog In/Out - Group 6	95
Main Menu - Communications and Options - Group 8	105
Main Menu - Profibus - Group 9	113
Main Menu - CAN Fieldbus - Group 10	122
Main Menu - LonWorks - Group 11	127
Main Menu - Smart Logic - Group 13	128
Main Menu - Special Functions -Group 14	143
Main Menu - Frequency Converter Information - Group 15	152
Main Menu - Data Readouts - Group 16	159
Main Menu - Data Readouts 2 - Group 18	165
Main Menu - FC Closed Loop - Group 20	167
Main Menu - Extended Closed Loop - FC 100 - Group 21	183
Main Menu - Application Functions - FC 100 - Group 22	195
Main Menu - Time-based Functions - FC 100 - Group 23	210
Main Menu - Application Functions 2 - Group 24	225
Main Menu - Cascade Controller - Group 25	232
Main Menu - Analog I/O Option MCB 109 - Group 26	245
4 Troubleshooting	255
Alarms and warnings	255
Alarm words	258
Warning words	259
Extended status words	260
Fault messages	261

5 Parameter Lists	265
Parameter Options	265
Default settings	265
0-** Operation and Display	266
1-** Load / Motor	268
2-** Brakes	269
3-** Reference / Ramps	270
4-** Limits / Warnings	271
5-** Digital In / Out	272
6-** Analog In / Out	274
8-** Communication and Options	276
9-** Profibus	277
10-** CAN Fieldbus	278
11-** LonWorks	279
13-** Smart Logic Controller	280
14-** Special Functions	281
15-** FC Information	282
16-** Data Readouts	284
18-** Info & Readouts	286
20-** FC Closed Loop	287
21-** Ext. Closed Loop	288
22-** Application Functions	290
23-** Time Based Functions	292
24-** Application Functions 2	293
25-** Cascade Controller	294
26-** Analog I / O Option MCB 109	296
Index	298

1 Introduction**1**

VLT HVAC Drive FC 100 Series Software version: 2.8.x



This guide can be used with all VLT HVAC Drive frequency converters with software version 2.8.x.
The actual software version number can be read from par. 15-43 *Software Version*.

2

2 How to Programme

2.1 Local Control Panel

2.1.1 How to operate graphical LCP (GLCP)

2

The following instructions are valid for the GLCP (LCP 102).

The GLCP is divided into four functional groups:

1. Graphical display with Status lines.
2. Menu keys and indicator lights (LED's) - selecting mode, changing parameters and switching between display functions.
3. Navigation keys and indicator lights (LEDs).
4. Operation keys and indicator lights (LEDs).

Graphical display:

The LCD-display is back-lit with a total of 6 alpha-numeric lines. All data is displayed on the LCP which can show up to five operating variables while in [Status] mode.

Display lines:

- a. **Status line:** Status messages displaying icons and graphics.
- b. **Line 1-2:** Operator data lines displaying data and variables defined or chosen by the user. By pressing the [Status] key, up to one extra line can be added.
- c. **Status line:** Status messages displaying text.

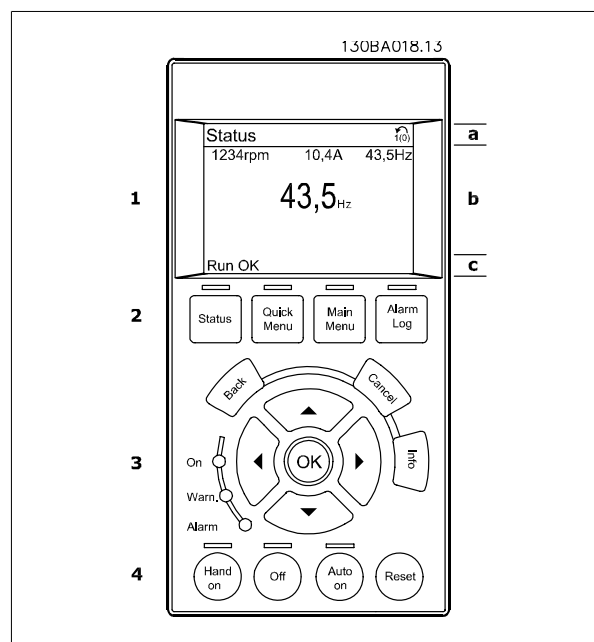

The display is divided into 3 sections:

Top section (a) shows the status when in status mode or up to 2 variables when not in status mode and in the case of Alarm/Warning.

2

The number of the Active Set-up (selected as the Active Set-up in par. 0-10 *Active Set-up* 0-10 Active Set-up) is shown. When programming in another Set-up than the Active Set-up, the number of the Set-up being programmed appears to the right in brackets.

The **Middle section** (b) shows up to 5 variables with related unit, regardless of status. In case of alarm/warning, the warning is shown instead of the variables.

It is possible to toggle between three status read-out displays by pressing the [Status] key. Operating variables with different formatting are shown in each status screen - see below.

Several values or measurements can be linked to each of the displayed operating variables. The values / measurements to be displayed can be defined via par. 0-20 *Display Line 1.1 Small* 0-20 Display Line 1.1 Small, par. 0-21 *Display Line 1.2 Small* 0-21 Display Line 1.2 Small, par. 0-22 *Display Line 1.3 Small* 0-22 Display Line 1.3 Small, par. 0-23 *Display Line 2 Large* 0-23 Display Line 2 Large, and par. 0-24 *Display Line 3 Large* 0-24 Display Line 3 Large, which can be accessed via [QUICK MENU], "Q3 Function Setups", "Q3-1 General Settings", "Q3-13 Display Settings".

Each value / measurement readout parameter selected in par. 0-20 *Display Line 1.1 Small* 0-20 Display Line 1.1 Small to par. 0-24 *Display Line 3 Large* 0-24 Display Line 3 Large has its own scale and number of digits after a possible decimal point. Larger numeric values are displayed with few digits after the decimal point.

Ex.: Current readout
5.25 A; 15.2 A 105 A.

Status display I:

This read-out state is standard after start-up or initialization. Use [INFO] to obtain information about the value/measurement linked to the displayed operating variables (1.1, 1.2, 1.3, 2, and 3). See the operating variables shown in the display in this illustration. 1.1, 1.2 and 1.3 are shown in small size. 2 and 3 are shown in medium size.

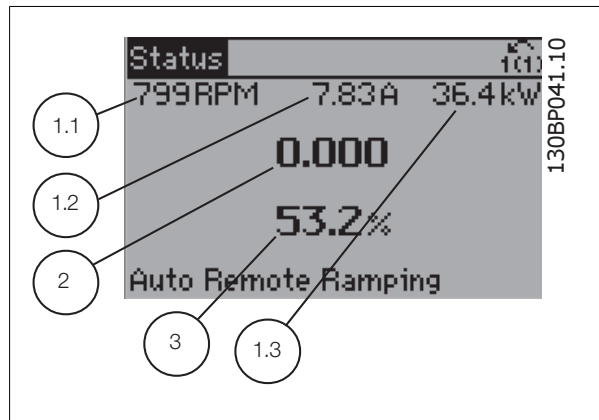

Status display II:

See the operating variables (1.1, 1.2, 1.3, and 2) shown in the display in this illustration. In the example, Speed, Motor current, Motor power and Frequency are selected as variables in the first and second lines. 1.1, 1.2 and 1.3 are shown in small size. 2 is shown in large size.

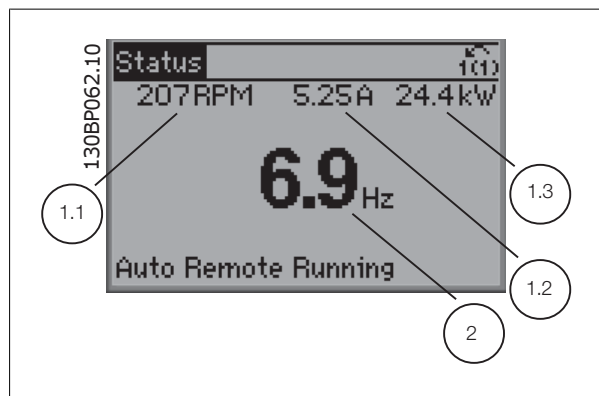

Status display III:

This state displays the event and action of the Smart Logic Control. For further information, see section *Smart Logic Control*.

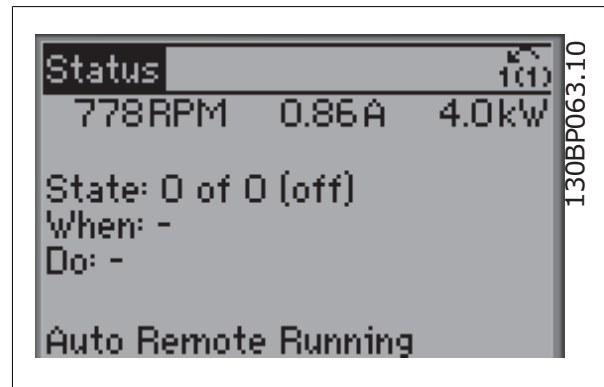

The **Bottom section** always shows the state of the frequency converter in Status mode.

Display Contrast Adjustment

Press [status] and [▲] for darker display

Press [status] and [▼] for brighter display

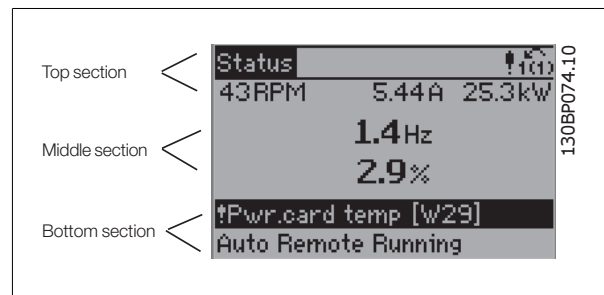

Indicator lights (LEDs):

If certain threshold values are exceeded, the alarm and/or warning LED lights up. A status and alarm text appear on the control panel. The On LED is activated when the frequency converter receives power from mains voltage, a DC bus terminal, or an external 24 V supply. At the same time, the back light is on.

- Green LED/On: Control section is working.
- Yellow LED/Warn.: Indicates a warning.
- Flashing Red LED/Alarm: Indicates an alarm.

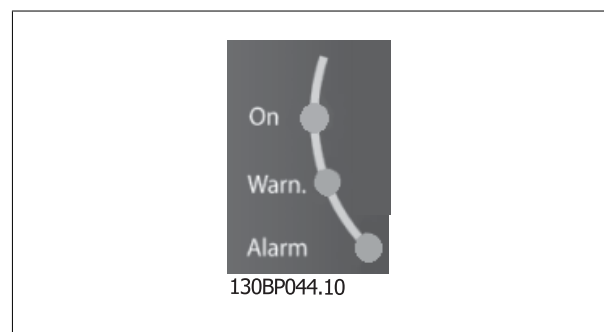

GLCP keys

Menu keys

The menu keys are divided into functions. The keys below the display and indicator lamps are used for parameter set-up, including choice of display indication during normal operation.

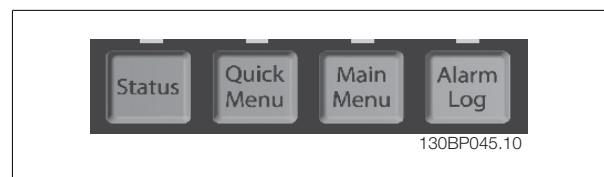

[Status]

indicates the status of the frequency converter and/or the motor. 3 different readouts can be chosen by pressing the [Status] key:

5 line readouts, 4 line readouts or Smart Logic Control.

Use [Status] for selecting the mode of display or for changing back to Display mode from either the Quick Menu mode, the Main Menu mode or Alarm mode. Also use the [Status] key to toggle single or double read-out mode.

2

[Quick Menu]

allows quick set-up of the frequency converter. **The most common HVAC functions can be programmed here.**

The [Quick Menu] consists of:

- **My Personal Menu**
- **Quick Set-up**
- **Function set-up**
- **Changes Made**
- **Loggings**

The Function set-up provides quick and easy access to all parameters required for the majority of HVAC applications including most VAV and CAV supply and return fans, cooling tower fans, Primary, Secondary and Condenser Water Pumps and other pump, fan and compressor applications. Amongst other features it also includes parameters for selecting which variables to display on the LCP, digital preset speeds, scaling of analog references, closed loop single zone and multi-zone applications and specific functions related to Fans, Pumps and Compressors.

The Quick Menu parameters can be accessed immediately unless a password has been created via par. 0-60 *Main Menu Password* 0-60 Main Menu Password, par. 0-61 *Access to Main Menu w/o Password* 0-61 Access to Main Menu w/o Password, par. 0-65 *Personal Menu Password* 0-65 Personal Menu Password or par. 0-66 *Access to Personal Menu w/o Password* 0-66 Access to Personal Menu w/o Password.

It is possible to switch directly between Quick Menu mode and Main Menu mode.

[Main Menu]

is used for programming all parameters. The Main Menu parameters can be accessed immediately unless a password has been created via par. 0-60 *Main Menu Password* 0-60 Main Menu Password, par. 0-61 *Access to Main Menu w/o Password* 0-61 Access to Main Menu w/o Password, par. 0-65 *Personal Menu Password* 0-65 Personal Menu Password or par. 0-66 *Access to Personal Menu w/o Password* 0-66 Access to Personal Menu w/o Password. For the majority of HVAC applications it is not necessary to access the Main Menu parameters but instead the Quick Menu, Quick Set-up and Function Set-up provides the simplest and quickest access to the typical required parameters.

It is possible to switch directly between Main Menu mode and Quick Menu mode.

Parameter shortcut can be carried out by pressing down the [Main Menu] key for 3 seconds. The parameter shortcut allows direct access to any parameter.

[Alarm Log]

displays an Alarm list of the five latest alarms (numbered A1-A5). To obtain additional details about an alarm, use the arrow keys to manoeuvre to the alarm number and press [OK]. Information is displayed about the condition of the frequency converter before it enters the alarm mode.

The Alarm log button on the LCP allows access to both Alarm log and Maintenance log.

[Back]

reverts to the previous step or layer in the navigation structure.

[Cancel]

last change or command will be cancelled as long as the display has not been changed.

[Info]

displays information about a command, parameter, or function in any display window. [Info] provides detailed information when needed.

Exit Info mode by pressing either [Info], [Back], or [Cancel].

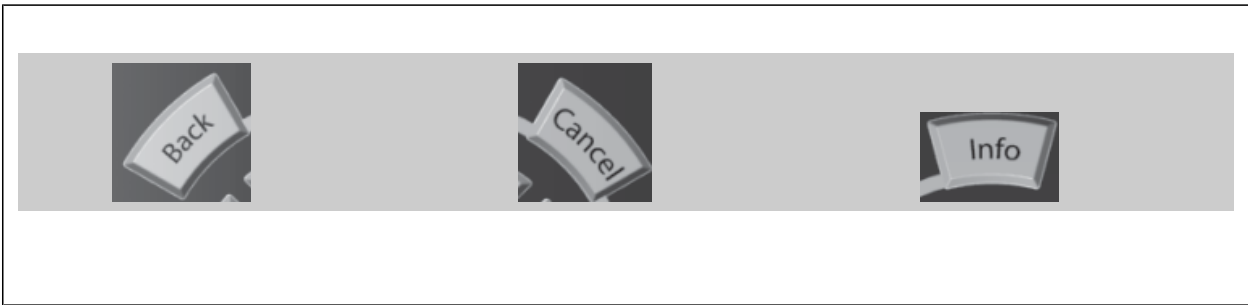

Navigation Keys

The four navigation arrows are used to navigate between the different choices available in [Quick Menu], [Main Menu] and [Alarm Log]. Use the keys to move the cursor.

[OK] is used for choosing a parameter marked by the cursor and for enabling the change of a parameter.



Operation Keys for local control are found at the bottom of the control panel.



[Hand On]

enables control of the frequency converter via the GLCP. [Hand on] also starts the motor, and it is now possible to enter the motor speed data by means of the arrow keys. The key can be selected as *Enable* [1] or *Disable* [0] via par. 0-40 [Hand on] Key on LCP0-40 [Hand on] Key on LCP.

The following control signals will still be active when [Hand on] is activated:

- [Hand on] - [Off] - [Auto on]
- Reset
- Coasting stop inverse
- Reversing
- Set-up select lsb - Set-up select msb
- Stop command from serial communication
- Quick stop
- DC brake

NB!
External stop signals activated by means of control signals or a serial bus will override a "start" command via the LCP.

[Off]

stops the connected motor. The key can be selected as *Enable* [1] or *Disable* [0] via par. 0-41 [Off] Key on LCP0-41 [Off] Key on LCP. If no external stop function is selected and the [Off] key is inactive the motor can only be stopped by disconnecting the mains supply.

[Auto On]

enables the frequency converter to be controlled via the control terminals and/or serial communication. When a start signal is applied on the control terminals and/or the bus, the frequency converter will start. The key can be selected as Enable [1] or Disable [0] via par. 0-42 *[Auto on] Key on LCP0-42 [Auto on] Key on LCP.*

NB!
An active HAND-OFF-AUTO signal via the digital inputs has higher priority than the control keys [Hand on] – [Auto on].

[Reset]

is used for resetting the frequency converter after an alarm (trip). It can be selected as *Enable [1] or Disable [0] via par. 0-43 [Reset] Key on LCP0-43 [Reset] Key on LCP.*

The parameter shortcut can be carried out by holding down the [Main Menu] key for 3 seconds. The parameter shortcut allows direct access to any parameter.

2.1.2 How to operate numeric LCP (NLCP)

The following instructions are valid for the NLCP (LCP 101).

The control panel is divided into four functional groups:

1. Numeric display.
2. Menu key and indicator lights (LEDs) - changing parameters and switching between display functions.
3. Navigation keys and indicator lights (LEDs).
4. Operation keys and indicator lights (LEDs).

NB!
Parameter copy is not possible with Numeric Local Control Panel (LCP101).

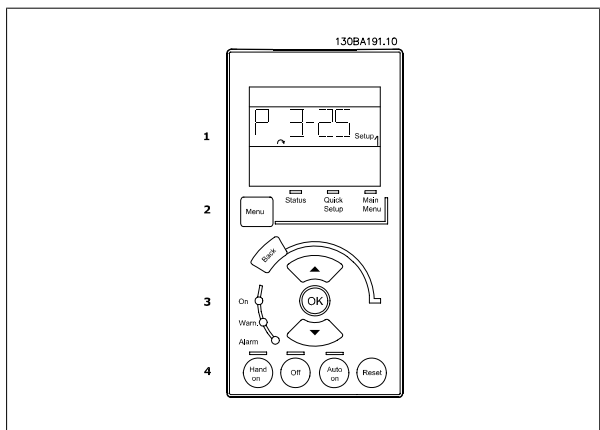

Illustration 2.1: Numerical LCP (NLCP)

Select one of the following modes:

Status Mode: Displays the status of the frequency converter or the motor.

If an alarm occurs, the NLCP automatically switches to status mode. A number of alarms can be displayed.

Quick Set-up or Main Menu Mode: Display parameters and parameter settings.



Illustration 2.2: Status display example

Indicator lights (LEDs):

- Green LED/On: Indicates if control section is on.
- Yellow LED/Wrn.: Indicates a warning.
- Flashing red LED/Alarm: Indicates an alarm.



Illustration 2.3: Alarm display example

Menu key

[Menu] Select one of the following modes:

- Status
- Quick Setup
- Main Menu

Main Menu is used for programming all parameters.

The parameters can be accessed immediately unless a password has been created via par. 0-60 *Main Menu Password*, par. 0-61 *Access to Main Menu w/o Password*, par. 0-65 *Personal Menu Password* or par. 0-66 *Access to Personal Menu w/o Password*.

Quick Setup is used to set up the frequency converter using only the most essential parameters.

The parameter values can be changed using the up/down arrows when the value is flashing.

Select Main Menu by pressing the [Menu] key a number of times until the Main Menu LED is lit.

Select the parameter group [xx-__] and press [OK]

Select the parameter [__-xx] and press [OK]

If the parameter is an array parameter select the array number and press [OK]

Select the wanted data value and press [OK]

Navigation Keys [Back] for stepping backwards

Arrow [▼] [▲] keys are used for manoeuvring between parameter groups, parameters and within parameters.

[OK] is used for choosing a parameter marked by the cursor and for enabling the change of a parameter.

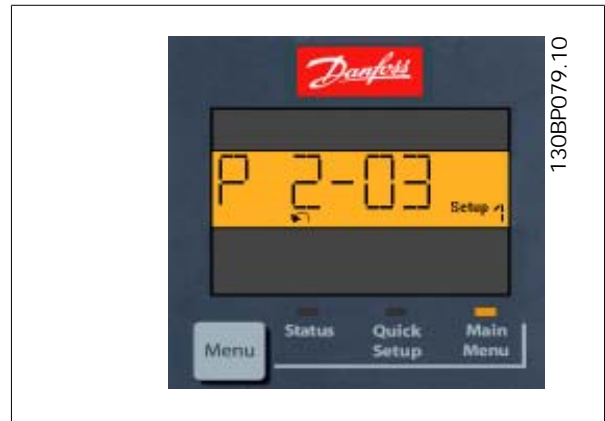

Illustration 2.4: Display example

Operation Keys

Keys for local control are found at the bottom of the control panel.



Illustration 2.5: Operation keys of the numerical CP (NLCP)

[Hand on] enables control of the frequency converter via the LCP. [Hand on] also starts the motor and it is now possible to enter the motor speed data by means of the arrow keys. The key can be selected as *Enable* [1] or *Disable* [0] via par. 0-40 *[Hand on] Key on LCP*.

External stop signals activated by means of control signals or a serial bus will override a 'start' command via the LCP.

The following control signals will still be active when [Hand on] is activated:

2

- [Hand on] - [Off] - [Auto on]
- Reset
- Coasting stop inverse
- Reversing
- Set-up select lsb - Set-up select msb
- Stop command from serial communication
- Quick stop
- DC brake

[Off] stops the connected motor. The key can be selected as *Enable* [1] or *Disable* [0] via par. 0-41 *[Off] Key on LCP*.

If no external stop function is selected and the [Off] key is inactive the motor can be stopped by disconnecting the mains supply.

[Auto on] enables the frequency converter to be controlled via the control terminals and/or serial communication. When a start signal is applied on the control terminals and/or the bus, the frequency converter will start. The key can be selected as *Enable* [1] or *Disable* [0] via par. 0-42 *[Auto on] Key on LCP*.

**NB!**

An active HAND-OFF-AUTO signal via the digital inputs has higher priority than the control keys [Hand on] [Auto on].

[Reset] is used for resetting the frequency converter after an alarm (trip). It can be selected as *Enable* [1] or *Disable* [0] via par. 0-43 *[Reset] Key on LCP*.

2.1.3 Quick Transfer of Parameter Settings between Multiple Frequency Converters

Once the set-up of a frequency converter is complete, we recommend that you store the data in the LCP or on a PC via MCT 10 Set-up Software Tool.

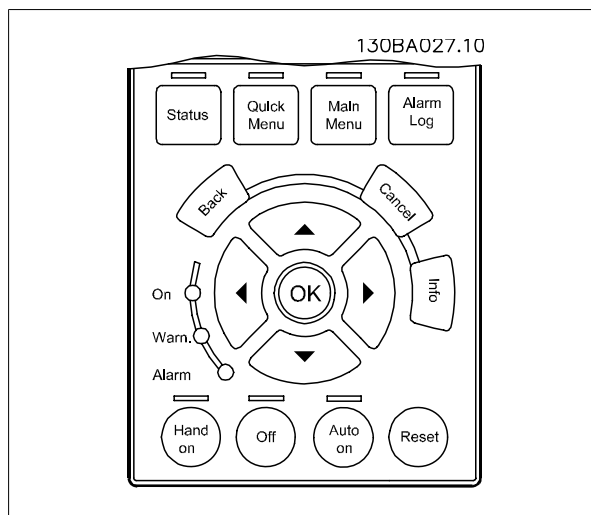
**Data storage in LCP:**

1. Go to par. 0-50 *LCP Copy*
2. Press the [OK] key
3. Select "All to LCP"

4. Press the [OK] key

All parameter settings are now stored in the LCP indicated by the progress bar. When 100% is reached, press [OK].



NB!
Stop the motor before performing this operation.

2

You can now connect the LCP to another frequency converter and copy the parameter settings to this frequency converter as well.

Data transfer from LCP to frequency converter:

1. Go to par. 0-50 *LCP Copy*
2. Press the [OK] key
3. Select "All from LCP"
4. Press the [OK] key

The parameter settings stored in the LCP are now transferred to the frequency converter indicated by the progress bar. When 100% is reached, press [OK].



NB!
Stop the motor before performing this operation.

2.1.4 Parameter Set-Up

The frequency converter can be used for practically all assignments, thus offering a significant number of parameters. The series offers a choice between two programming modes - the Quick Menu mode and the Main Menu mode.

The latter provides access to all parameters. The former takes the user through a few parameters making it possible to **program the majority of VLT HVAC Drive applications**.

Regardless of the mode of programming, you can change a parameter both in the Quick Menu mode and in the Main Menu mode.

2.1.5 Quick Menu Mode

Parameter Data

The graphical display (GLCP) provides access to all parameters listed under the Quick Menus. The numeric display (NLCP) only provides access to the Quick Setup parameters. To set parameters using the [Quick Menu] button - enter or change parameter data or settings in accordance with the following procedure:

1. Press Quick Menu button
2. Use the [▲] and [▼] buttons to find the parameter you want to change
3. Press [OK]
4. Use [▲] and [▼] buttons to select the correct parameter setting
5. Press [OK]
6. To move to a different digit within a parameter setting, use the [◀] and [▶] buttons
7. Highlighted area indicates digit selected for change
8. Press [Cancel] button to disregard change, or press [OK] to accept change and enter the new setting

Example of Changing Parameter Data

Assume parameter 22-60 is set to [Off]. However, you want to monitor the fan-belt condition - non- broken or broken - according to the following procedure:

1. Press Quick Menu key
2. Choose Function Setups with the [▼] button
3. Press [OK]
4. Choose Application Settings with the [▼] button
5. Press [OK]
6. Press [OK] again for Fan Functions
7. Choose Broken Belt Function by pressing [OK]
8. With [▼] button, choose [2] Trip

The frequency converter will now trip if a broken fan-belt is detected.

Select [My Personal Menu] to display personal parameters:

Select [My Personal Menu] to display only the parameters, which have been pre-selected and programmed as personal parameters. For example, an AHU or pump OEM may have pre-programmed personal parameters to be in My Personal Menu during factory commissioning to make on-site commissioning/ fine tuning simpler. These parameters are selected in par. 0-25 *My Personal Menu*. Up to 20 different parameters can be programmed in this menu.

Select [Changes Made] to get information about:

- the last 10 changes. Use the up/down navigation keys to scroll between the last 10 changed parameters.
- the changes made since default setting.

Select [Loggings] to get information about the display line read-outs. The information is shown as graphs.

Only display parameters selected in par. 0-20 *Display Line 1.1 Small* and par. 0-24 *Display Line 3 Large* can be viewed. It is possible to store up to 120 samples in the memory for later reference.

Efficient Parameter Set-up for VLT HVAC Drive Applications:

The parameters can easily be set up for the vast majority of the VLT HVAC Drive applications only by using the [Quick Setup] option.

After pressing [Quick Menu], the different choices in the Quick Menu are listed. See also illustration 6.1 below and tables Q3-1 to Q3-4 in the following *Function Setups* section.

Example of using the Quick Setup option:

Assume you want to set the Ramp Down Time to 100 seconds!

1. Select [Quick Setup]. The first par. 0-01 *Language* in Quick Setup appears
2. Press [▼] repeatedly until par. 3-42 *Ramp 1 Ramp Down Time* appears with the default setting of 20 seconds
3. Press [OK]
4. Use the [◀] button to highlight the 3rd digit before the comma
5. Change '0' to '1' by using the [▲] button
6. Use the [▶] button to highlight the digit '2'
7. Change '2' to '0' with the [▼] button
8. Press [OK]

The new ramp-down time is now set to 100 seconds.

It is recommended to do the set-up in the order listed.



NB!

A complete description of the function is found in the parameter sections of this manual.

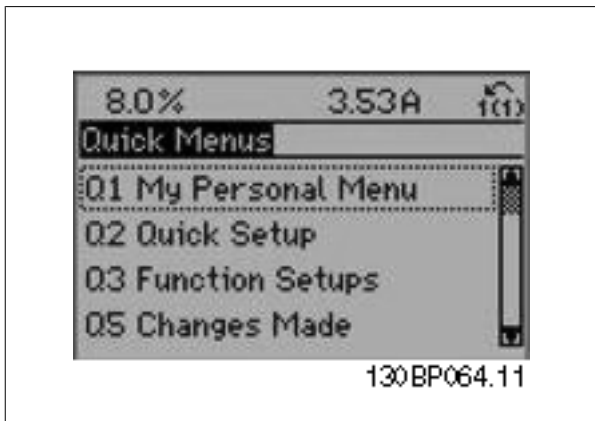

Illustration 2.6: Quick Menu view.

The Quick Setup menu gives access to the 13 most important setup parameters of the frequency converter. After programming the frequency converter will, in most cases be ready for operation. The 13 (see footnote) Quick Setup parameters are shown in the table below. A complete description of the function is given in the parameter description sections of this manual.

Par.	[Units]
par. 0-01 <i>Language</i>	
par. 1-20 <i>Motor Power [kW]</i>	[kW]
par. 1-21 <i>Motor Power [HP]</i>	[HP]
par. 1-22 <i>Motor Voltage</i>	[V]
par. 1-23 <i>Motor Frequency</i>	[Hz]
par. 1-24 <i>Motor Current</i>	[A]
par. 1-25 <i>Motor Nominal Speed</i>	[RPM]
par. 1-28 <i>Motor Rotation Check</i>	[Hz]
par. 3-41 <i>Ramp 1 Ramp Up Time</i>	[s]
par. 3-42 <i>Ramp 1 Ramp Down Time</i>	[s]
par. 4-11 <i>Motor Speed Low Limit [RPM]</i>	[RPM]
par. 4-12 <i>Motor Speed Low Limit [Hz]</i>	[Hz]
par. 4-13 <i>Motor Speed High Limit [RPM]</i>	[RPM]
par. 4-14 <i>Motor Speed High Limit [Hz]</i>	[Hz]
par. 3-19 <i>Jog Speed [RPM]</i>	[RPM]
par. 3-11 <i>Jog Speed [Hz]</i>	[Hz]
par. 5-12 <i>Terminal 27 Digital Input</i>	
par. 5-40 <i>Function Relay</i>	

Table 2.1: Quick Setup parameters

*The display showing depends on choices made in par. 0-02 *Motor Speed Unit* and par. 0-03 *Regional Settings*. The default settings of par. 0-02 *Motor Speed Unit* and par. 0-03 *Regional Settings* depend on which region of the world the frequency converter is supplied to but can be re-programmed as required.

** par. 5-40 *Function Relay*, is an array, where one may choose between Relay1 [0] or Relay2 [1]. Standard setting is Relay1 [0] with the default choice Alarm [9].

See the parameter description later in this chapter under Function Setup parameters.

For a detailed information about settings and programming, please see the *VLT HVAC Drive Programming Guide, MG.11.CX.YY*

x=version number

y=language

NB!
 If [No Operation] is selected in par. 5-12 *Terminal 27 Digital Input*, no connection to +24 V on terminal 27 is necessary to enable start.
 If [Coast Inverse] (factory default value) is selected in par. 5-12 *Terminal 27 Digital Input*, a connection to +24V is necessary to enable start.

2.1.6 Function Setups

The Function set-up provides quick and easy access to all parameters required for the majority of VLT HVAC Drive applications including most VAV and CAV supply and return fans, cooling tower fans, Primary, Secondary and Condenser Water Pumps and other pump, fan and compressor applications.

2

How to access Function set-up - example

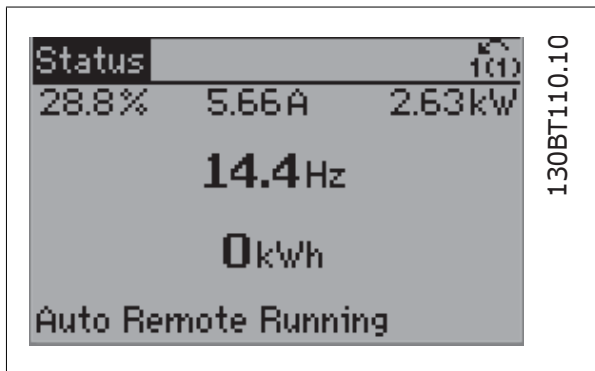

Illustration 2.7: Step 1: Turn on the frequency converter (yellow LED lights)

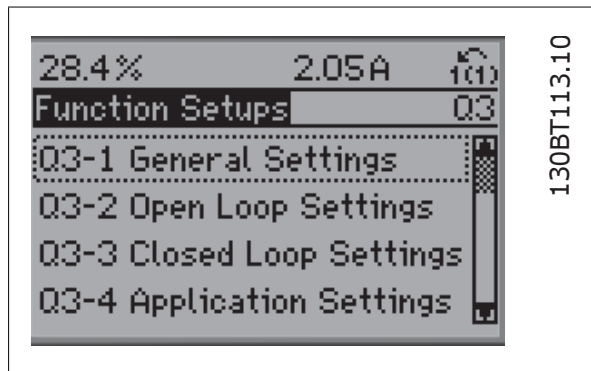

Illustration 2.10: Step 4: Function set-ups choices appear. Choose 03-1 *General Settings*. Press [OK].

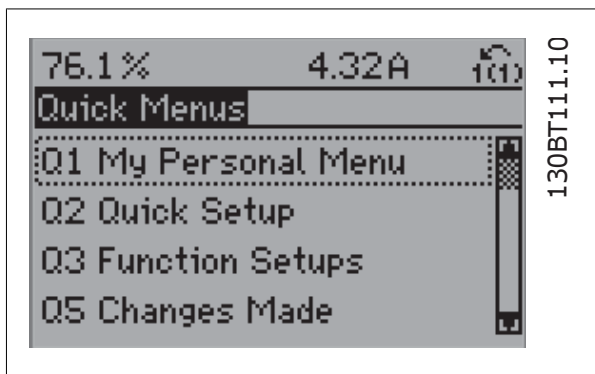

Illustration 2.8: Step 2: Press the [Quick Menus] button (Quick Menus choices appear).

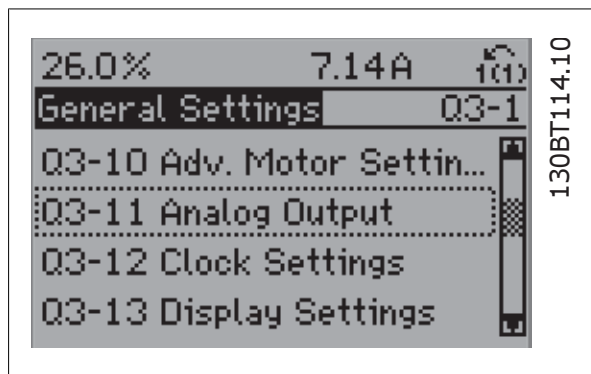

Illustration 2.11: Step 5: Use the up/down navigation keys to scroll down to i.e. 03-11 *Analog Outputs*. Press [OK].

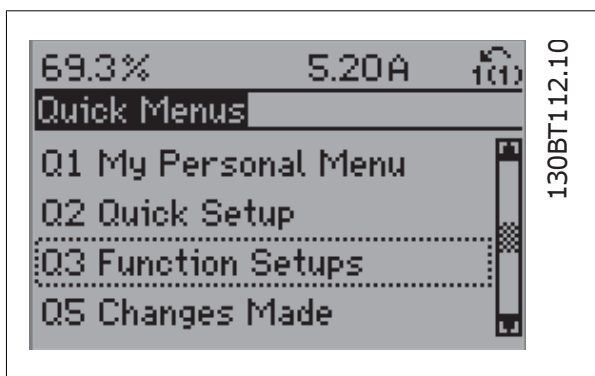

Illustration 2.9: Step 3: Use the up/down navigation keys to scroll down to Function set-ups. Press [OK].

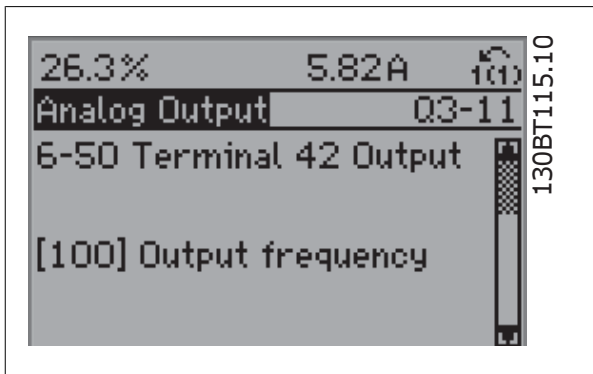

Illustration 2.12: Step 6: Choose par. 6-50. Press [OK].

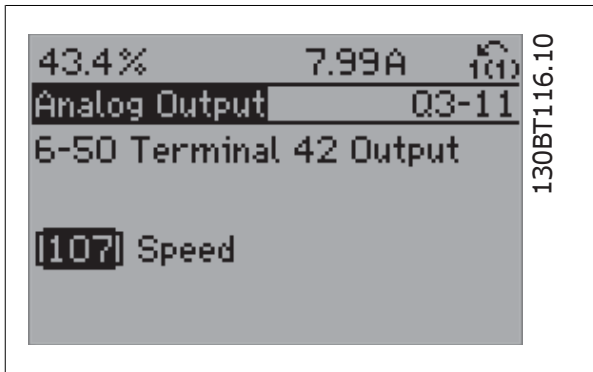

Illustration 2.13: Step 7: Use the up/down navigation keys to select between the different choices. Press [OK].

Function Set-ups parameters

The Function Setups parameters are grouped in the following way:

Q3-1 General Settings			
Q3-10 Adv. Motor Settings	Q3-11 Analog Output	Q3-12 Clock Settings	Q3-13 Display Settings
par. 1-90 <i>Motor Thermal Protection</i>	par. 6-50 <i>Terminal 42 Output</i>	par. 0-70 <i>Date and Time</i>	par. 0-20 <i>Display Line 1.1 Small</i>
par. 1-93 <i>Thermistor Source</i>	par. 6-51 <i>Terminal 42 Output Min Scale</i>	par. 0-71 <i>Date Format</i>	par. 0-21 <i>Display Line 1.2 Small</i>
par. 1-29 <i>Automatic Motor Adaptation (AMA)</i>	par. 6-52 <i>Terminal 42 Output Max Scale</i>	par. 0-72 <i>Time Format</i>	par. 0-22 <i>Display Line 1.3 Small</i>
par. 14-01 <i>Switching Frequency</i>		par. 0-74 <i>DST/Summertime</i>	par. 0-23 <i>Display Line 2 Large</i>
par. 4-53 <i>Warning Speed High</i>		par. 0-76 <i>DST/Summertime Start</i>	par. 0-24 <i>Display Line 3 Large</i>
		par. 0-77 <i>DST/Summertime End</i>	par. 0-37 <i>Display Text 1</i>
			par. 0-38 <i>Display Text 2</i>
			par. 0-39 <i>Display Text 3</i>

Q3-2 Open Loop Settings	
Q3-20 Digital Reference	Q3-21 Analog Reference
par. 3-02 <i>Minimum Reference</i>	par. 3-02 <i>Minimum Reference</i>
par. 3-03 <i>Maximum Reference</i>	par. 3-03 <i>Maximum Reference</i>
par. 3-10 <i>Preset Reference</i>	par. 6-10 <i>Terminal 53 Low Voltage</i>
par. 5-13 <i>Terminal 29 Digital Input</i>	par. 6-11 <i>Terminal 53 High Voltage</i>
par. 5-14 <i>Terminal 32 Digital Input</i>	par. 6-12 <i>Terminal 53 Low Current</i>
par. 5-15 <i>Terminal 33 Digital Input</i>	par. 6-13 <i>Terminal 53 High Current</i>
	par. 6-14 <i>Terminal 53 Low Ref./Feedb. Value</i>
	par. 6-15 <i>Terminal 53 High Ref./Feedb. Value</i>

Q3-3 Closed Loop Settings

Q3-30 Single Zone Int. Set Point	Q3-31 Single Zone Ext. Set Point	Q3-32 Multi Zone / Adv
par. 1-00 <i>Configuration Mode</i>	par. 1-00 <i>Configuration Mode</i>	par. 1-00 <i>Configuration Mode</i>
par. 20-12 <i>Reference/Feedback Unit</i>	par. 20-12 <i>Reference/Feedback Unit</i>	par. 3-15 <i>Reference 1 Source</i>
par. 20-13 <i>Minimum Reference/Feedb.</i>	par. 20-13 <i>Minimum Reference/Feedb.</i>	par. 3-16 <i>Reference 2 Source</i>
par. 20-14 <i>Maximum Reference/Feedb.</i>	par. 20-14 <i>Maximum Reference/Feedb.</i>	par. 20-00 <i>Feedback 1 Source</i>
par. 6-22 <i>Terminal 54 Low Current</i>	par. 6-10 <i>Terminal 53 Low Voltage</i>	par. 20-01 <i>Feedback 1 Conversion</i>
par. 6-24 <i>Terminal 54 Low Ref./Feedb. Value</i>	par. 6-11 <i>Terminal 53 High Voltage</i>	par. 20-02 <i>Feedback 1 Source Unit</i>
par. 6-25 <i>Terminal 54 High Ref./Feedb. Value</i>	par. 6-12 <i>Terminal 53 Low Current</i>	par. 20-03 <i>Feedback 2 Source</i>
par. 6-26 <i>Terminal 54 Filter Time Constant</i>	par. 6-13 <i>Terminal 53 High Current</i>	par. 20-04 <i>Feedback 2 Conversion</i>
par. 6-27 <i>Terminal 54 Live Zero</i>	par. 6-14 <i>Terminal 53 Low Ref./Feedb. Value</i>	par. 20-05 <i>Feedback 2 Source Unit</i>
par. 6-00 <i>Live Zero Timeout Time</i>	par. 6-15 <i>Terminal 53 High Ref./Feedb. Value</i>	par. 20-06 <i>Feedback 3 Source</i>
par. 6-01 <i>Live Zero Timeout Function</i>	par. 6-22 <i>Terminal 54 Low Current</i>	par. 20-07 <i>Feedback 3 Conversion</i>
par. 20-21 <i>Setpoint 1</i>	par. 6-24 <i>Terminal 54 Low Ref./Feedb. Value</i>	par. 20-08 <i>Feedback 3 Source Unit</i>
par. 20-81 <i>PID Normal/ Inverse Control</i>	par. 6-25 <i>Terminal 54 High Ref./Feedb. Value</i>	par. 20-12 <i>Reference/Feedback Unit</i>
par. 20-82 <i>PID Start Speed [RPM]</i>	par. 6-26 <i>Terminal 54 Filter Time Constant</i>	par. 20-13 <i>Minimum Reference/Feedb.</i>
par. 20-83 <i>PID Start Speed [Hz]</i>	par. 6-27 <i>Terminal 54 Live Zero</i>	par. 20-14 <i>Maximum Reference/Feedb.</i>
par. 20-93 <i>PID Proportional Gain</i>	par. 6-00 <i>Live Zero Timeout Time</i>	par. 6-10 <i>Terminal 53 Low Voltage</i>
par. 20-94 <i>PID Integral Time</i>	par. 6-01 <i>Live Zero Timeout Function</i>	par. 6-11 <i>Terminal 53 High Voltage</i>
	par. 20-81 <i>PID Normal/ Inverse Control</i>	par. 6-12 <i>Terminal 53 Low Current</i>
	par. 20-82 <i>PID Start Speed [RPM]</i>	par. 6-13 <i>Terminal 53 High Current</i>
	par. 20-83 <i>PID Start Speed [Hz]</i>	par. 6-14 <i>Terminal 53 Low Ref./Feedb. Value</i>
	par. 20-93 <i>PID Proportional Gain</i>	par. 6-15 <i>Terminal 53 High Ref./Feedb. Value</i>
	par. 20-94 <i>PID Integral Time</i>	par. 6-16 <i>Terminal 53 Filter Time Constant</i>
		par. 6-17 <i>Terminal 53 Live Zero</i>
		par. 6-20 <i>Terminal 54 Low Voltage</i>
		par. 6-21 <i>Terminal 54 High Voltage</i>
		par. 6-22 <i>Terminal 54 Low Current</i>
		par. 6-23 <i>Terminal 54 High Current</i>
		par. 6-24 <i>Terminal 54 Low Ref./Feedb. Value</i>
		par. 6-25 <i>Terminal 54 High Ref./Feedb. Value</i>
		par. 6-26 <i>Terminal 54 Filter Time Constant</i>
		par. 6-27 <i>Terminal 54 Live Zero</i>
		par. 6-00 <i>Live Zero Timeout Time</i>
		par. 6-01 <i>Live Zero Timeout Function</i>
		par. 4-56 <i>Warning Feedback Low</i>
		par. 4-57 <i>Warning Feedback High</i>
		par. 20-20 <i>Feedback Function</i>
		par. 20-21 <i>Setpoint 1</i>
		par. 20-22 <i>Setpoint 2</i>
		par. 20-81 <i>PID Normal/ Inverse Control</i>
		par. 20-82 <i>PID Start Speed [RPM]</i>
		par. 20-83 <i>PID Start Speed [Hz]</i>
		par. 20-93 <i>PID Proportional Gain</i>
		par. 20-94 <i>PID Integral Time</i>
		par. 20-70 <i>Closed Loop Type</i>
		par. 20-71 <i>PID Performance</i>
		par. 20-72 <i>PID Output Change</i>
		par. 20-73 <i>Minimum Feedback Level</i>
		par. 20-74 <i>Maximum Feedback Level</i>
		par. 20-79 <i>PID Autotuning</i>

Q3-4 Application Settings		
Q3-40 Fan Functions	Q3-41 Pump Functions	Q3-42 Compressor Functions
par. 22-60 <i>Broken Belt Function</i>	par. 22-20 <i>Low Power Auto Set-up</i>	par. 1-03 <i>Torque Characteristics</i>
par. 22-61 <i>Broken Belt Torque</i>	par. 22-21 <i>Low Power Detection</i>	par. 1-71 <i>Start Delay</i>
par. 22-62 <i>Broken Belt Delay</i>	par. 22-22 <i>Low Speed Detection</i>	par. 22-75 <i>Short Cycle Protection</i>
par. 4-64 <i>Semi-Auto Bypass Set-up</i>	par. 22-23 <i>No-Flow Function</i>	par. 22-76 <i>Interval between Starts</i>
par. 1-03 <i>Torque Characteristics</i>	par. 22-24 <i>No-Flow Delay</i>	par. 22-77 <i>Minimum Run Time</i>
par. 22-22 <i>Low Speed Detection</i>	par. 22-40 <i>Minimum Run Time</i>	par. 5-01 <i>Terminal 27 Mode</i>
par. 22-23 <i>No-Flow Function</i>	par. 22-41 <i>Minimum Sleep Time</i>	par. 5-02 <i>Terminal 29 Mode</i>
par. 22-24 <i>No-Flow Delay</i>	par. 22-42 <i>Wake-up Speed [RPM]</i>	par. 5-12 <i>Terminal 27 Digital Input</i>
par. 22-40 <i>Minimum Run Time</i>	par. 22-43 <i>Wake-up Speed [Hz]</i>	par. 5-13 <i>Terminal 29 Digital Input</i>
par. 22-41 <i>Minimum Sleep Time</i>	par. 22-44 <i>Wake-up Ref./FB Difference</i>	par. 5-40 <i>Function Relay</i>
par. 22-42 <i>Wake-up Speed [RPM]</i>	par. 22-45 <i>Setpoint Boost</i>	par. 1-73 <i>Flying Start</i>
par. 22-43 <i>Wake-up Speed [Hz]</i>	par. 22-46 <i>Maximum Boost Time</i>	par. 1-86 <i>Trip Speed Low [RPM]</i>
par. 22-44 <i>Wake-up Ref./FB Difference</i>	par. 22-26 <i>Dry Pump Function</i>	par. 1-87 <i>Trip Speed Low [Hz]</i>
par. 22-45 <i>Setpoint Boost</i>	par. 22-27 <i>Dry Pump Delay</i>	
par. 22-46 <i>Maximum Boost Time</i>	par. 22-80 <i>Flow Compensation</i>	
par. 2-10 <i>Brake Function</i>	par. 22-81 <i>Square-linear Curve Approximation</i>	
par. 2-16 <i>AC brake Max. Current</i>	par. 22-82 <i>Work Point Calculation</i>	
par. 2-17 <i>Over-voltage Control</i>	par. 22-83 <i>Speed at No-Flow [RPM]</i>	
par. 1-73 <i>Flying Start</i>	par. 22-84 <i>Speed at No-Flow [Hz]</i>	
par. 1-71 <i>Start Delay</i>	par. 22-85 <i>Speed at Design Point [RPM]</i>	
par. 1-80 <i>Function at Stop</i>	par. 22-86 <i>Speed at Design Point [Hz]</i>	
par. 2-00 <i>DC Hold/Preheat Current</i>	par. 22-87 <i>Pressure at No-Flow Speed</i>	
par. 4-10 <i>Motor Speed Direction</i>	par. 22-88 <i>Pressure at Rated Speed</i>	
	par. 22-89 <i>Flow at Design Point</i>	
	par. 22-90 <i>Flow at Rated Speed</i>	
	par. 1-03 <i>Torque Characteristics</i>	
	par. 1-73 <i>Flying Start</i>	

See also *VLTR HVAC Drive Programming Guide* for a detailed description of the Function Setups parameter groups.

2.1.7 Main Menu Mode

Select the Main Menu mode by pressing the [Main Menu] key. The below read-out appears on the display.

The middle and bottom sections on the display show a list of parameter groups which can be chosen by toggling the up and down buttons.

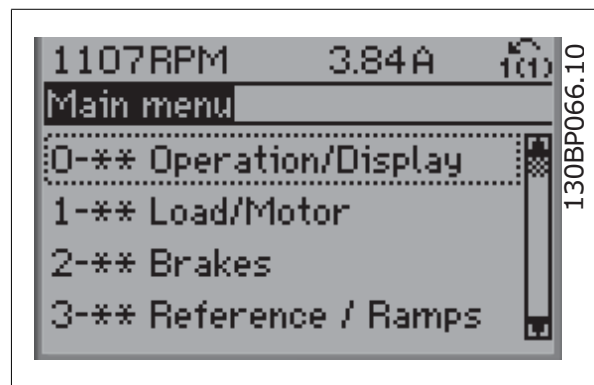

Each parameter has a name and number which remain the same regardless of the programming mode. In the Main Menu mode, the parameters are divided into groups. The first digit of the parameter number (from the left) indicates the parameter group number.

All parameters can be changed in the Main Menu. However, depending on the choice of configuration (par. 1-00 *Configuration Mode*), some parameters can be hidden.

2.1.8 Parameter Selection

In the Main Menu mode, the parameters are divided into groups. You select a parameter group by means of the navigation keys.

The following parameter groups are accessible:

Group no.	Parameter group:
0	Operation/Display
1	Load/Motor
2	Brakes
3	References/Ramps
4	Limits/Warnings
5	Digital In/Out
6	Analog In/Out
8	Comm. and Options
9	Profibus
10	CAN Fieldbus
11	LonWorks
13	Smart Logic
14	Special Functions
15	FC Information
16	Data Readouts
18	Data Readouts 2
20	Drive Closed Loop
21	Ext. Closed Loop
22	Application Functions
23	Time-based Functions
25	Cascade Controller
26	Analog I/O Option MCB 109

After selecting a parameter group, choose a parameter by means of the navigation keys.

The middle section on the display shows the parameter number and name as well as the selected parameter value.

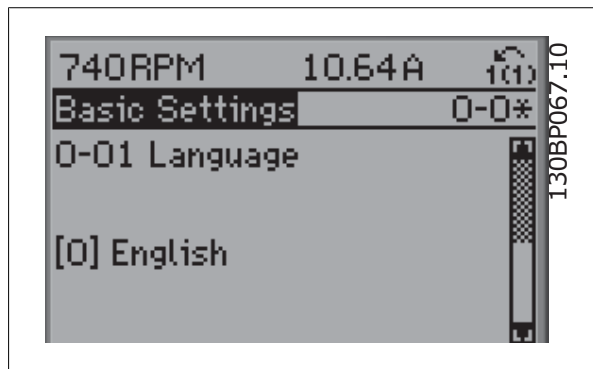

2.1.9 Changing Data

The procedure for changing data is the same whether you select a parameter in the Quick menu or the Main menu mode. Press [OK] to change the selected parameter.

The procedure for changing data depends on whether the selected parameter represents a numerical data value or a text value.

2.1.10 Changing a Text Value

If the selected parameter is a text value, change the text value by means of the [▲] [▼] navigation keys.

The up key increases the value, and the down key decreases the value.

Place the cursor on the value you want to save and press [OK].

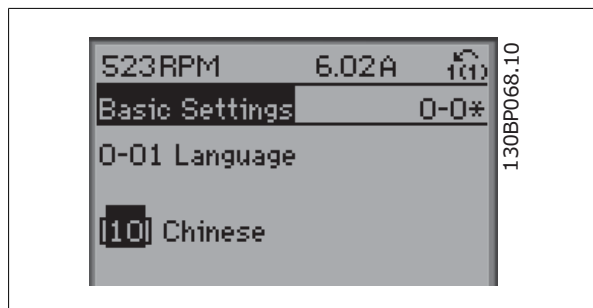

2.1.11 Changing a Group of Numeric Data Values

If the chosen parameter represents a numeric data value, change the chosen data value by means of the [◀] [▶] navigation keys as well as the [▲] [▼] navigation keys. Use the [◀] [▶] navigation keys to move the cursor horizontally.

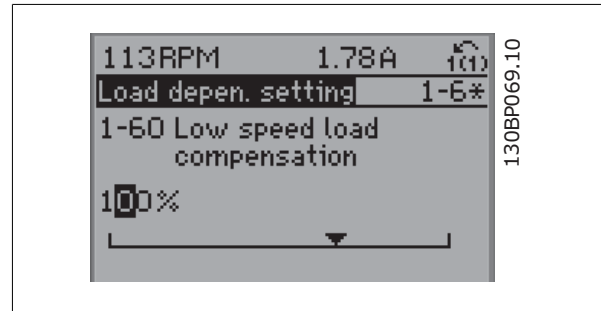

Use the [▲] [▼] navigation keys to change the data value. The up key enlarges the data value, and the down key reduces the data value. Place the cursor on the value you want to save and press [OK].

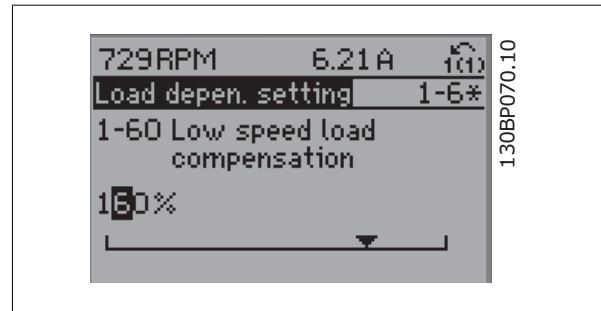

2.1.12 Changing a Data Value, Step-by-Step

Certain parameters can be changed step by step or infinitely varying. This applies to par. 1-20 *Motor Power [kW]*, par. 1-22 *Motor Voltage* and par. 1-23 *Motor Frequency*.

The parameters are changed both as a group of numeric data values and as numeric data values infinitely varying.

2.1.13 Read-out and Programming of Indexed Parameters

Parameters are indexed when placed in a rolling stack.

par. 15-30 *Alarm Log: Error Code* to par. 15-33 *Alarm Log: Date and Time* contain a fault log which can be read out. Choose a parameter, press [OK], and use the up/down navigation keys to scroll through the value log.

Use par. 3-10 *Preset Reference* as another example:

Choose the parameter, press [OK], and use the up/down navigation keys to scroll through the indexed values. To change the parameter value, select the indexed value and press [OK]. Change the value by using the up/down keys. Press [OK] to accept the new setting. Press [CANCEL] to abort. Press [Back] to leave the parameter.

2.1.14 Initialisation to Default Settings

Initialise the frequency converter to default settings in two ways:

2

Recommended initialisation (via par. 14-22 *Operation Mode*)

1. Select par. 14-22 *Operation Mode*
2. Press [OK]
3. Select "Initialisation"
4. Press [OK]
5. Cut off the mains supply and wait until the display turns off.
6. Reconnect the mains supply - the frequency converter is now reset.
7. Change par. 14-22 *Operation Mode* back to *Normal Operation*.



NB!

Resets parameters selected in Personal Menu with default factory setting.

par. 14-22 *Operation Mode* initialises all except:

par. 14-50 *RFI Filter*

par. 8-30 *Protocol*

par. 8-31 *Address*

par. 8-32 *Baud Rate*

par. 8-35 *Minimum Response Delay*

par. 8-36 *Maximum Response Delay*

par. 8-37 *Maximum Inter-Char Delay*

par. 15-00 *Operating Hours* to par. 15-05 *Over Volt's*

par. 15-20 *Historic Log: Event* to par. 15-22 *Historic Log: Time*

par. 15-30 *Alarm Log: Error Code* to par. 15-32 *Alarm Log: Time*

Manual initialisation

1. Disconnect from mains and wait until the display turns off.
 - 2a. Press [Status] - [Main Menu] - [OK] at the same time while power up for LCP 102, Graphical Display
 - 2b. Press [Menu] while power up for LCP 101, Numerical Display
 3. Release the keys after 5 s.
 4. The frequency converter is now programmed according to default settings.
- This procedure initializes all except: par. 15-00 *Operating Hours*; par. 15-03 *Power Up's*; par. 15-04 *Over Temp's*; par. 15-05 *Over Volt's*.



NB!

When you carry out manual initialisation, you also reset serial communication, par. 14-50 *RFI Filter* and fault log settings.

Removes parameters selected in par. 25-00 *Cascade Controller*.



NB!

After initialization and power cycling, the display will not show any information until after a couple of minutes.

3 Parameter Description

3.1 Parameter Selection

Parameters for the frequency converter are grouped into various parameter groups for easy selection of the correct parameters for optimized operation of the frequency converter.

The vast majority of VLT HVAC Drive applications can be programmed using the Quick Menu button and selecting the parameters under Quick Setup and Function Setups.

Descriptions and default settings of parameters may be found under the section Parameter Lists at the back of this manual.

0-xx Operation/Display	10-xx CAN FieldbusAO-## Analog I/O Options
1-xx Load/Motor	11-xx LonWorks
2-xx Brakes	13-xx Smart Logic ControllerPB-## Profibus
3-xx Reference/Ramps	14-xx Special Functions
4-xx Limits/ Warnings	15-xx FC InformationBN-## BACnet
5-xx Digital In/Out	16-xx Data Readouts
6-xx Analog In/Out	18-xx Info & Readouts
8-xx Comm. and Options	20-xx FC Closed LoopLG-## Logs & I/O Opt. Status
9-xx Profibus	21-xx Ext. Closed Loop
	22-xx Application Functions
	23-xx Time Based Functions
	24-xx Application Functions 2
	25-xx Cascade Controller
	26-xx Analog I/O Option MCB 109

3.2 Main Menu - Operation and Display - Group 0

3.2.1 0-** Operation / Display

Parameters related to the fundamental functions of the frequency converter, function of the LCP buttons and configuration of the LCP display.

3.2.2 0-0* Basic Settings

Parameter group for basic frequency converter settings.

0-01 Language

Option:
Function:

Defines the language to be used in the display.

The frequency converter can be delivered with 2 different language packages. English and German are included in both packages. English cannot be erased or manipulated.

[0] *	English	Part of Language packages 1 - 2
[1]	Deutsch	Part of Language packages 1 - 2
[2]	Francais	Part of Language package 1
[3]	Dansk	Part of Language package 1
[4]	Spanish	Part of Language package 1
[5]	Italiano	Part of Language package 1
[6]	Svenska	Part of Language package 1
[7]	Nederlands	Part of Language package 1
[10]	Chinese	Language package 2
[20]	Suomi	Part of Language package 1
[22]	English US	Part of Language package 1
[27]	Greek	Part of Language package 1
[28]	Bras.port	Part of Language package 1
[36]	Slovenian	Part of Language package 1
[39]	Korean	Part of Language package 2
[40]	Japanese	Part of Language package 2
[41]	Turkish	Part of Language package 1
[42]	Trad.Chinese	Part of Language package 2
[43]	Bulgarian	Part of Language package 1
[44]	Srpski	Part of Language package 1
[45]	Romanian	Part of Language package 1
[46]	Magyar	Part of Language package 1
[47]	Czech	Part of Language package 1
[48]	Polski	Part of Language package 1
[49]	Russian	Part of Language package 1
[50]	Thai	Part of Language package 2
[51]	Bahasa Indonesia	Part of Language package 2

0-02 Motor Speed Unit

Option:

Function:

This parameter cannot be adjusted while the motor is running. The display showing depends on settings in par. 0-02 *Motor Speed Unit* and par. 0-03 *Regional Settings*. The default setting of par. 0-02 *Motor Speed Unit* and par. 0-03 *Regional Settings* depends on which region of the world the frequency converter is supplied to, but can be re-programmed as required.



NB!
Changing the *Motor Speed Unit* will reset certain parameters to their initial value. It is recommended to select the motor speed unit first, before modifying other parameters.

[0] RPM Selects display of motor speed variables and parameters (i.e. references, feedbacks and limits) in terms of motor speed (RPM).

[1] * Hz Selects display of motor speed variables and parameters (i.e. references, feedbacks and limits) in terms of output frequency to the motor (Hz).

0-03 Regional Settings

Option:

Function:

This parameter cannot be adjusted while the motor is running. The display showing depends on settings in par. 0-02 *Motor Speed Unit* and par. 0-03 *Regional Settings*. The default setting of par. 0-02 *Motor Speed Unit* and par. 0-03 *Regional Settings* depends on which region of the world the frequency converter is supplied to but can be re-programmed as required.

[0] * International Sets par. 1-20 *Motor Power [kW]* units to [kW] and the default value of par. 1-23 *Motor Frequency* [50 Hz].

[1] North America Sets par. 1-21 *Motor Power [HP]* units to HP and the default value of par. 1-23 *Motor Frequency* to 60 Hz.

The setting not used is made invisible.

0-04 Operating State at Power-up

Option:

Function:

Select the operating mode upon reconnection of the frequency converter to mains voltage after power down when operating in Hand (local) mode.

[0] * Resume Resumes operation of the frequency converter maintaining the same local reference and the same start/stop condition (applied by [Hand On]/[Off] on the LCP or Hand Start via a digital input as before the frequency converter was powered down.

[1] Forced stop, ref=old Uses saved reference [1] to stop the frequency converter but at the same time retain in memory the local speed reference prior to power down. After mains voltage is reconnected and after receiving a start command (using the LCP [Hand On] button or Hand Start command via a digital input) the frequency converter restarts and operates at the retained speed reference.

0-05 Local Mode Unit

Option:

Function:

Defines if the local reference unit should be displayed in terms of the motor shaft speed (in RPM/Hz) or as percent.

[0] * As Motor Speed Unit

[1] %

3.2.3 0-1 * Set-up Operations

Define and control the individual parameter set-ups.

The frequency converter has four parameter setups that can be programmed independently of each other. This makes the frequency converter very flexible and able to meet the requirements of many different VLT HVAC Drive system control schemes often saving the cost of external control equipment. For example these can be used to program the frequency converter to operate according to one control scheme in one setup (e.g. daytime operation) and another control scheme in another setup (e.g. night set back). Alternatively they can be used by an AHU or packaged unit OEM to identically program all their factory fitted frequency converters for different equipment models within a range to have the same parameters and then during production/commissioning simply select a specific setup depending on which model within that range the frequency converter is installed on.

The active setup (i.e. the setup in which the frequency converter is currently operating) can be selected in par. 0-10 *Active Set-up* and is displayed in the LCP. Using Multi set-up it is possible to switch between set-ups with the frequency converter running or stopped, via digital input or serial communication commands (e.g. for night set back). If it is necessary to change setups whilst running, ensure par. 0-12 *This Set-up Linked to* is programmed as required. For the majority of VLT HVAC Drive applications it will not be necessary to program par. 0-12 *This Set-up Linked to* even if change of set up whilst running is required, but for very complex applications, using the full flexibility of the multiple setups, it may be required. Using par. 0-11 *Programming Set-up* it is possible to edit parameters within any of the setups whilst continuing the frequency converter operation in its Active Setup which can be a different setup to that being edited. Using par. 0-51 *Set-up Copy* it is possible to copy parameter settings between the set-ups to enable quicker commissioning if similar parameter settings are required in different set-ups.

0-10 Active Set-up

Option:

Function:

Select the set-up in which the frequency converter is to operate.

Use par. 0-51 *Set-up Copy* to copy a set-up to one or all other set-ups. To avoid conflicting settings of the same parameter within two different set-ups, link the set-ups together using par. 0-12 *This Set-up Linked to*. Stop the frequency converter before switching between set-ups where parameters marked 'not changeable during operation' have different values.

Parameters which are 'not changeable during operation' are marked FALSE in the parameter lists in the section *Parameter Lists*

[0]	Factory setup	Cannot be changed. It contains the Danfoss data set, and can be used as a data source when returning the other set-ups to a known state.
[1] *	Set-up 1	<i>Set-up 1</i> [1] to <i>Set-up 4</i> [4] are the four separate parameter set-ups within which all parameters can be programmed.
[2]	Set-up 2	
[3]	Set-up 3	
[4]	Set-up 4	
[9]	Multi Set-up	Is used for remote selection of set-ups using digital inputs and the serial communication port. This set-up uses the settings from par. 0-12 <i>This Set-up Linked to</i> .

0-11 Programming Set-up

Option:

Function:

Select the set-up to be edited (i.e. programmed) during operation; either the active set-up or one of the inactive set-ups. The set-up number being edited is displayed in the LCP in (brackets).

[0]	Factory setup	cannot be edited but it is useful as a data source to return the other set-ups to a known state.
[1]	Set-up 1	<i>Set-up 1</i> [1] to <i>Set-up 4</i> [4] can be edited freely during operation, independently of the active set-up.
[2]	Set-up 2	
[3]	Set-up 3	
[4]	Set-up 4	
[9] *	Active Set-up	(i.e. the set-up in which the frequency converter is operating) can also be edited during operation. Editing parameters in the chosen setup would normally be done from the LCP but it is also possible from any of the serial communication ports.

0-12 This Set-up Linked to

Option:

Function:

This parameter only needs to be programmed if changing set-ups is required whilst the motor is running. It ensures that parameters which are "not changeable during operation" have the same setting in all relevant set-ups.

To enable conflict-free changes from one set-up to another whilst the frequency converter is running, link set-ups containing parameters which are not changeable during operation. The link will ensure synchronising of the 'not changeable during operation' parameter values when moving from one set-up to another during operation. 'Not changeable during operation' parameters can be identified by the label FALSE in the parameter lists in the section *Parameter Lists*.

The par. 0-12 *This Set-up Linked to* feature is used when Multi set-up in par. 0-10 *Active Set-up* is selected. Multi set-up can be used to move from one set-up to another during operation (i.e. while the motor is running).

Example:

Use Multi set-up to shift from Set-up 1 to Set-up 2 whilst the motor is running. Programme parameters in Set-up 1 first, then ensure that Set-up 1 and Set-up 2 are synchronised (or 'linked'). Synchronisation can be performed in two ways:

1. Change the edit set-up to *Set-up 2* [2] in par. 0-11 *Programming Set-up* and set par. 0-12 *This Set-up Linked to* to *Set-up 1* [1]. This will start the linking (synchronising) process.

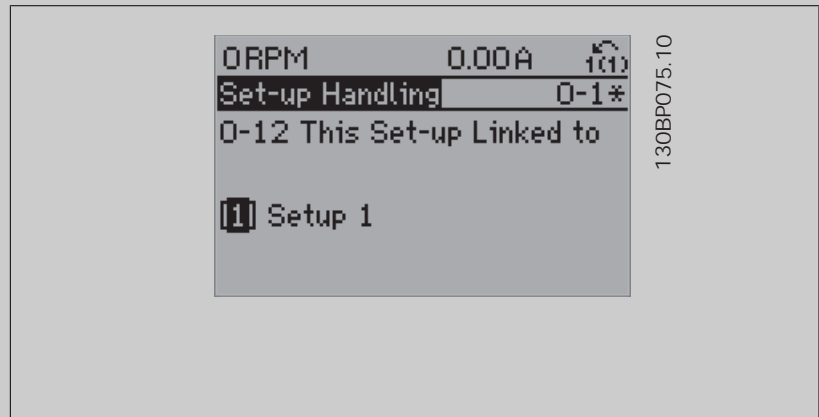

OR

2. While still in Set-up 1, using par. 0-50 *LCP Copy*, copy Set-up 1 to Set-up 2. Then set par. 0-12 *This Set-up Linked to* to *Set-up 2* [2]. This will start the linking process.

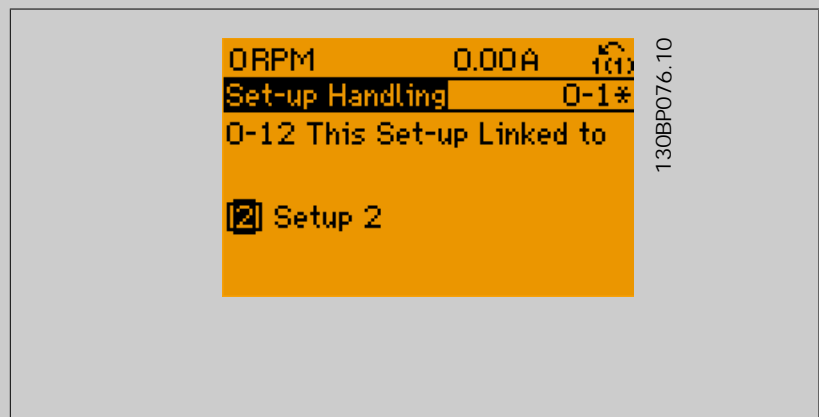

After the link is complete, par. 0-13 *Readout: Linked Set-ups* will read {1,2} to indicate that all 'not changeable during operation' parameters are now the same in Set-up 1 and Set-up 2. If there are changes to a 'not changeable during operation' parameter, e.g. par. 1-30 *Stator Resistance (Rs)*, in Set-up 2, they will also be changed automatically in Set-up 1. A switch between Set-up 1 and Set-up 2 during operation is now possible.

[0] *	Not linked
[1]	Set-up 1
[2]	Set-up 2
[3]	Set-up 3
[4]	Set-up 4

0-13 Readout: Linked Set-ups

Array [5]

Range:

0 N/A* [0 - 255 N/A]

Function:

View a list of all the set-ups linked by means of par. 0-12 *This Set-up Linked to*. The parameter has one index for each parameter set-up. The parameter value displayed for each index represents which setups are linked to that parameter setup.

Index	LCP value
0	{0}
1	{1,2}
2	{1,2}
3	{3}
4	{4}

Table 3.1: Example: Set-up 1 and Set-up 2 are linked

0-14 Readout: Prog. Set-ups / Channel

Range:

0 N/A* [-2147483648 - 2147483647 N/A]

Function:

View the setting of par. 0-11 *Programming Set-up* for each of the four different communication channels. When the number is displayed in hex, as it is in the LCP, each number represents one channel.

Numbers 1-4 represent a set-up number; 'F' means factory setting; and 'A' means active set-up. The channels are, from right to left: LCP, FC-bus, USB, HPPB1.5.

Example: The number AAAAAA21h means that the FC bus selected Set-up 2 in par. 0-11 *Programming Set-up*, the LCP selected Set-up 1 and all others used the active set-up.

3.2.4 0-2* LCP Display

Define the variables displayed in the Graphical Local Control Panel.



NB!

Please refer to par. 0-37 *Display Text 1*, par. 0-38 *Display Text 2* and par. 0-39 *Display Text 3* for information on how to write display texts

0-20 Display Line 1.1 Small

Option:

[0] None

[37] Display Text 1

[38] Display Text 2

Function:

Select a variable for display in line 1, left position.

No display value selected

Enables an individual text string to be written, for display in the LCP or to be read via serial communication.

Enables an individual text string to be written, for display in the LCP or to be read via serial communication.

[39]	Display Text 3	Enables an individual text string to be written, for display in the LCP or to be read via serial communication.
[89]	Date and Time Readout	Displays the current date and time.
[953]	Profibus Warning Word	Displays Profibus communication warnings.
[1005]	Readout Transmit Error Counter	View the number of CAN control transmission errors since the last power-up.
[1006]	Readout Receive Error Counter	View the number of CAN control receipt errors since the last power-up.
[1007]	Readout Bus Off Counter	View the number of Bus Off events since the last power-up.
[1013]	Warning Parameter	View a DeviceNet-specific warning word. One separate bit is assigned to every warning.
[1115]	LON Warning Word	Shows the LON-specific warnings.
[1117]	XIF Revision	Shows the version of the external interface file of the Neuron C chip on the LON option.
[1118]	LonWorks Revision	
[1501]	Running Hours	View the number of running hours of the motor.
[1502]	kWh Counter	View the mains power consumption in kWh.
[1600]	Control Word	View the Control Word sent from the frequency converter via the serial communication port in hex code.
[1601]	Reference [Unit]	Total reference (sum of digital/analog/preset/bus/freeze ref./catch up and slow-down) in selected unit.
[1602] *	Reference [%]	
[1603]	Status Word	Present status word
[1605]	Main Actual Value [%]	View the two-byte word sent with the Status word to the bus Master reporting the Main Actual Value.
[1609]	Custom Readout	View the user-defined readouts as defined in par. 0-30 <i>Custom Readout Unit</i> , par. 0-31 <i>Custom Readout Min Value</i> and par. 0-32 <i>Custom Readout Max Value</i> .
[1610]	Power [kW]	Actual power consumed by the motor in kW.
[1611]	Power [hp]	Actual power consumed by the motor in HP.
[1612]	Motor Voltage	Voltage supplied to the motor.
[1613]	Frequency	
[1614]	Motor Current	Phase current of the motor measured as effective value.
[1615]	Frequency [%]	Motor frequency, i.e. the output frequency from the frequency converter in percent.
[1616]	Torque [Nm]	Present motor load as a percentage of the rated motor torque.
[1617]	Speed [RPM]	Motor speed reference. Actual speed will depend on slip compensation being used (compensation set in par. 1-62). If not used, actual speed will be the value read in the display minus motor slip.
[1618]	Motor Thermal	Thermal load on the motor, calculated by the ETR function. See also parameter group 1-9* Motor Temperature.
[1622]	Torque [%]	Shows the actual torque produced, in percentage.
[1630]	DC Link Voltage	Intermediate circuit voltage in the frequency converter.
[1632]	Brake Energy /s	
[1633]	Brake Energy /2 min	
[1634]	Heatsink Temp.	Present heat sink temperature of the frequency converter. The cut-out limit is $95 \pm 5^\circ \text{C}$; cutting back in occurs at $70 \pm 5^\circ \text{C}$.
[1635]	Inverter Thermal	
[1636]	Inv. Nom. Current	Nominal current of the frequency converter

[1637]	Inv. Max. Current	Maximum current of the frequency converter
[1638]	SL Controller State	
[1639]	Control Card Temp.	Temperature of the control card.
[1650]	External Reference	Sum of the external reference as a percentage, i.e. the sum of analog/pulse/bus.
[1652]	Feedback [Unit]	Reference value from programmed digital input(s).
[1653]	Digi Pot Reference	View the contribution of the digital potentiometer to the actual reference Feedback.
[1654]	Feedback 1 [Unit]	View the value of Feedback 1. See also par. 20-0*.
[1655]	Feedback 2 [Unit]	View the value of Feedback 2. See also par. 20-0*.
[1656]	Feedback 3 [Unit]	View the value of Feedback 3. See also par. 20-0*.
[1658]	PID Output [%]	Returns the Drive Closed Loop PID controller output value in percent.
[1660]	Digital Input	Displays the status of the digital inputs. Signal low = 0; Signal high = 1. Regarding order, see par. 16-60. Bit 0 is at the extreme right.
[1661]	Terminal 53 Switch Setting	Setting of input terminal 53. Current = 0; Voltage = 1.
[1662]	Analog Input 53	Actual value at input 53 either as a reference or protection value.
[1663]	Terminal 54 Switch Setting	Setting of input terminal 54. Current = 0; Voltage = 1.
[1664]	Analog Input 54	Actual value at input 54 either as reference or protection value.
[1665]	Analog Output 42 [mA]	Actual value at output 42 in mA. Use par. 6-50 to select the variable to be represented by output 42.
[1666]	Digital Output [bin]	Binary value of all digital outputs.
[1667]	Pulse Input #29 [Hz]	
[1668]	Pulse Input #33 [Hz]	
[1669]	Pulse Output #27 [Hz]	Actual value of pulses applied to terminal 27 in digital output mode.
[1670]	Pulse Output #29 [Hz]	Actual value of pulses applied to terminal 29 in digital output mode.
[1671]	Relay Output [bin]	View the setting of all relays.
[1672]	Counter A	View the present value of Counter A.
[1673]	Counter B	View the present value of Counter B.
[1675]	Analog In X30/11	
[1676]	Analog In X30/12	
[1677]	Analog Out X30/8 [mA]	
[1680]	Fieldbus CTW 1	Control word (CTW) received from the Bus Master.
[1682]	Fieldbus REF 1	Main reference value sent with control word via the serial communications network e.g. from the BMS, PLC or other master controller.
[1684]	Comm. Option STW	Extended fieldbus communication option status word.
[1685]	FC Port CTW 1	Control word (CTW) received from the Bus Master.
[1686]	FC Port REF 1	Status word (STW) sent to the Bus Master.
[1690]	Alarm Word	One or more alarms in a Hex code (used for serial communications)
[1691]	Alarm Word 2	One or more alarms in a Hex code (used for serial communications)
[1692]	Warning Word	One or more warnings in a Hex code (used for serial communications)
[1693]	Warning Word 2	One or more warnings in a Hex code (used for serial communications)
[1694]	Ext. Status Word	One or more status conditions in a Hex code (used for serial communications)

[1695]	Ext. Status Word 2	One or more status conditions in a Hex code (used for serial communications)
[1696]	Maintenance Word	The bits reflect the status for the programmed Preventive Maintenance Events in parameter group 23-1*
[1830]	Analog Input X42/1	Shows the value of the signal applied to terminal X42/1 on the Analog I/O card.
[1831]	Analog Input X42/3	Shows the value of the signal applied to terminal X42/3 on the Analog I/O card.
[1832]	Analog Input X42/5	Shows the value of the signal applied to terminal X42/5 on the Analog I/O card.
[1833]	Analog Out X42/7 [V]	Shows the value of the signal applied to terminal X42/7 on the Analog I/O card.
[1834]	Analog Out X42/9 [V]	Shows the value of the signal applied to terminal X42/9 on the Analog I/O card.
[1835]	Analog Out X42/11 [V]	Shows the value of the signal applied to terminal X42/11 on the Analog I/O card.
[2117]	Ext. 1 Reference [Unit]	The value of the reference for extended Closed Loop Controller 1
[2118]	Ext. 1 Feedback [Unit]	The value of the feedback signal for extended Closed Loop Controller 1
[2119]	Ext. 1 Output [%]	The value of the output from extended Closed Loop Controller 1
[2137]	Ext. 2 Reference [Unit]	The value of the reference for extended Closed Loop Controller 2
[2138]	Ext. 2 Feedback [Unit]	The value of the feedback signal for extended Closed Loop Controller 2
[2139]	Ext. 2 Output [%]	The value of the output from extended Closed Loop Controller 2
[2157]	Ext. 3 Reference [Unit]	The value of the reference for extended Closed Loop Controller 3
[2158]	Ext. 3 Feedback [Unit]	The value of the feedback signal for extended Closed Loop Controller 3
[2159]	Ext. 3 Output [%]	The value of the output from extended Closed Loop Controller 3
[2230]	No-Flow Power	The calculated No Flow Power for the actual operating speed
[2316]	Maintenance Text	
[2580]	Cascade Status	Status for the operation of the Cascade Controller
[2581]	Pump Status	Status for the operation of each individual pump controlled by the Cascade Controller
[3110]	Bypass Status Word	
[3111]	Bypass Running Hours	

NB!
Please consult the *VLT HVAC Drive Programming Guide, MG.11.CX.YY* for detailed information.

0-21 Display Line 1.2 Small

Option: **Function:**
Select a variable for display in line 1, middle position.

[1614] *	Motor Current	The options are the same as those listed in par. 0-20, <i>Display Line 1.1 Small</i> .
----------	---------------	--

0-22 Display Line 1.3 Small

Option: **Function:**
Select a variable for display in line 1, right position.

[1610] *	Power [kW]	The options are the same as those listed in par. 0-20, <i>Display Line 1.1 Small</i> .
----------	------------	--

0-23 Display Line 2 Large

Option: **Function:**
Select a variable for display in line 2.

[1613] * Frequency

The options are the same as those listed in par. 0-20, *Display Line 1.1 Small*.

0-24 Display Line 3 Large

Option:

Function:

Select a variable for display in line 3.

[1502] * kWh Counter

The options are the same as those listed in par. 0-20, *Display Line 1.1 Small*.

0-25 My Personal Menu

Array [20]

Range:

Function:

0 N/A* [0 - 9999 N/A]

Define up to 20 parameters to appear in the Q1 Personal Menu, accessible via the [Quick Menu] key on the LCP. The parameters will be displayed in the Q1 Personal Menu in the order they are programmed into this array parameter. Delete parameters by setting the value to '0000'. For example, this can be used to provide quick, simple access to just one or up to 20 parameters which require changing on a regular basis (e.g. for plant maintenance reasons) or by an OEM to enable simple commissioning of their equipment.

3

3.2.5 LCP Custom Readout, Par. 0-3*

It is possible to customize the display elements for various purposes: *Custom Readout. Value proportional to speed (Linear, squared or cubed depending on unit selected in par. 0-30 *Custom Readout Unit*) *Display Text. Text string stored in a parameter.

Custom Readout

The calculated value to be displayed is based on settings in par. 0-30 *Custom Readout Unit*, par. 0-31 *Custom Readout Min Value* (linear only), par. 0-32 *Custom Readout Max Value*, par. 4-13 *Motor Speed High Limit [RPM]*, par. 4-14 *Motor Speed High Limit [Hz]* and actual speed.

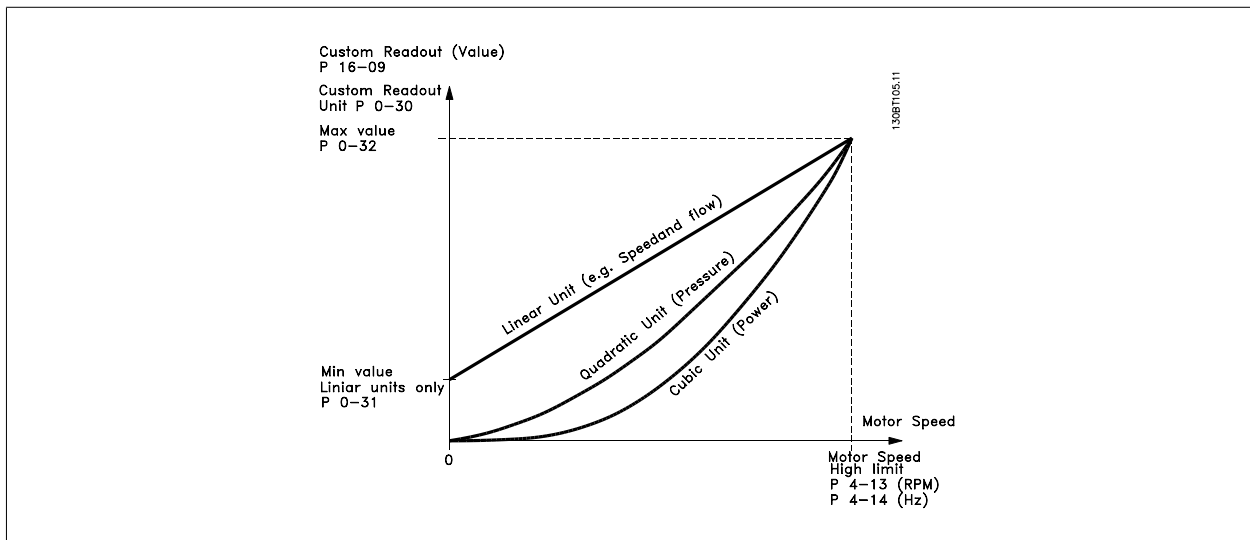

The relation will depend on the type of unit selected in par. 0-30 *Custom Readout Unit*.

Unit Type	Speed Relation
Dimensionless	Linear
Speed	
Flow, volume	
Flow, mass	
Velocity	
Length	
Temperature	
Pressure	Quadratic
Power	Cubic

0-30 Custom Readout Unit

Option:

Function:

Program a value to be shown in the display of the LCP. The value has a linear, squared or cubed relation to speed. This relation depends on the unit selected (see table above). The actual calculated value can be read in par. 16-09 *Custom Readout*, and/or shown in the display by selecting Custom Readout [16-09] in par. 0-20 *Display Line 1.1 Small* to par. 0-24 *Display Line 3 Large*.

[0]

[1] * %

[5] PPM

[10] 1/min

[11] RPM

[12] Pulse/s

[20] l/s

[21] l/min

[22] l/h

[23] m³/s

[24] m³/min

[25] m³/h

[30] kg/s

[31] kg/min

[32] kg/h

[33] t/min

[34] t/h

[40] m/s

[41] m/min

[45] m

[60] °C

[70] mbar

[71] bar

[72] Pa

[73] kPa

[74] m WG

[75] mm Hg

[80] kW

[120] GPM

[121] gal/s

[122] gal/min

[123] gal/h

[124]	CFM
[125]	ft ³ /s
[126]	ft ³ /min
[127]	ft ³ /h
[130]	lb/s
[131]	lb/min
[132]	lb/h
[140]	ft/s
[141]	ft/min
[145]	ft
[160]	°F
[170]	psi
[171]	lb/in ²
[172]	in WG
[173]	ft WG
[174]	in Hg
[180]	HP

0-31 Custom Readout Min Value

Range:

0.00 Cus- [0.00 - 100.00 CustomReadoutUnit]
tomReadou-
tUnit*

Function:

This parameter allows the choice of the min. value of the custom defined readout (occurs at zero speed). It is only possible to select a value different to 0 when selecting a linear unit in par. 0-30 *Custom Readout Unit*. For Quadratic and Cubic units the minimum value will be 0.

0-32 Custom Readout Max Value

Range:

100.00 Cus- [par. 0-31 - 999999.99 CustomRea-
tomReadou-
tUnit*]

Function:

This parameter sets the max value to be shown when the speed of the motor has reached the set value for (par. 4-13 *Motor Speed High Limit [RPM]* and par. 4-14 *Motor Speed High Limit [Hz]*).

0-37 Display Text 1

Range:

0 N/A* [0 - 0 N/A]

Function:

In this parameter it is possible to write an individual text string for display in the LCP or to be read via serial communication. If to be displayed permanently select Display Text 1 in par. 0-20 *Display Line 1.1 Small*, par. 0-21 *Display Line 1.2 Small*, par. 0-22 *Display Line 1.3 Small*, par. 0-23 *Display Line 2 Large* or par. 0-24 *Display Line 3 Large*. Use the ▲ or ▼ buttons on the LCP to change a character. Use the ◀ and ▶ buttons to move the cursor. When a character is highlighted by the cursor, it can be changed. Use the ▲ or ▼ buttons on the LCP to change a character. A character can be inserted by placing the cursor between two characters and pressing ▲ or ▼.

0-38 Display Text 2

Range:

0 N/A* [0 - 0 N/A]

Function:

In this parameter it is possible to write an individual text string for display in the LCP or to be read via serial communication. If to be displayed permanently select Display Text 2 in par. 0-20 *Display Line 1.1 Small*, par. 0-21 *Display Line 1.2 Small*, par. 0-22 *Display Line 1.3 Small*, par. 0-23 *Display Line 2 Large* or par. 0-24 *Display Line 3 Large*. Use the ▲ or ▼ buttons on the LCP to change a character. Use the ◀ and ▶ buttons to move the cursor. When a character is highlighted by the cursor, this character can be changed. A character can be inserted by placing the cursor between two characters and pressing ▲ or ▼.

0-39 Display Text 3

Range:

0 N/A* [0 - 0 N/A]

Function:

In this parameter it is possible to write an individual text string for display in the LCP or to be read via serial communication. If to be displayed permanently select Display Text 3 in par. 0-20 *Display Line 1.1 Small*, par. 0-21 *Display Line 1.2 Small*, par. 0-22 *Display Line 1.3 Small*, par. 0-23 *Display Line 2 Large* or par. 0-24 *Display Line 3 Large*. Use the ▲ or ▼ buttons on the LCP to change a character. Use the ◀ and ▶ buttons to move the cursor. When a character is highlighted by the cursor, this character can be changed. A character can be inserted by placing the cursor between two characters and pressing ▲ or ▼.

3.2.6 LCP Keypad, 0-4*

Enable, disable and password protect individual keys on the LCP.

0-40 [Hand on] Key on LCP

Option:

[0] Disabled

Function:

No function

[1] * Enabled

[Hand on] Key enabled

[2] Password

Avoid unauthorized start in Hand mode. If par. 0-40 *[Hand on] Key on LCP* is included in the My Personal Menu, then define the password in par. 0-65 *Personal Menu Password*. Otherwise define the password in par. 0-60 *Main Menu Password*.

0-41 [Off] Key on LCP

Option:

[0] Disabled

Function:

No function

[1] * Enabled

[Off] Key is enabled

[2] Password

Avoid unauthorized stop. If par. 0-41 *[Off] Key on LCP* is included in the My Personal Menu, then define the password in par. 0-65 *Personal Menu Password*. Otherwise define the password in par. 0-60 *Main Menu Password*.

0-42 [Auto on] Key on LCP

Option:

[0] Disabled

Function:

No function

[1] * Enabled

[Auto on] Key is enabled

[2] Password

Avoid unauthorized start in Auto mode. If par. 0-42 *[Auto on] Key on LCP* is included in the My Personal Menu, then define the password in par. 0-65 *Personal Menu Password*. Otherwise define the password in par. 0-60 *Main Menu Password*.

0-43 [Reset] Key on LCP

Option:

[0] Disabled

Function:

No function

[1] * Enabled

[Reset] Key is enabled

[2] Password

Avoid unauthorized resetting. If par. 0-43 *[Reset] Key on LCP* is included in the par. 0-25 *My Personal Menu*, then define the password in par. 0-65 *Personal Menu Password*. Otherwise define the password in par. 0-60 *Main Menu Password*.

3.2.7 0-5* Copy / Save

Copy parameter settings between set-ups and to/from the LCP.

0-50 LCP Copy

Option:	Function:
[0] * No copy	No function
[1] All to LCP	Copies all parameters in all set-ups from the frequency converter memory to the LCP memory. For service purposes it is recommended to copy all parameters to the LCP after commissioning.
[2] All from LCP	Copies all parameters in all set-ups from the LCP memory to the frequency converter memory.
[3] Size indep. from LCP	Copies only the parameters that are independent of the motor size. The latter selection can be used to programme several frequency converters with the same function without disturbing motor data which are already set.

This parameter cannot be adjusted while the motor is running.

0-51 Set-up Copy

Option:	Function:
[0] * No copy	No function
[1] Copy to set-up 1	Copies all parameters in the present Programming Set-up (defined in par. 0-11 <i>Programming Set-up</i>) to Set-up 1.
[2] Copy to set-up 2	Copies all parameters in the present Programming Set-up (defined in par. 0-11 <i>Programming Set-up</i>) to Set-up 2.
[3] Copy to set-up 3	Copies all parameters in the present Programming Set-up (defined in par. 0-11 <i>Programming Set-up</i>) to Set-up 3.
[4] Copy to set-up 4	Copies all parameters in the present Programming Set-up (defined in par. 0-11 <i>Programming Set-up</i>) to Set-up 4.
[9] Copy to all	Copies the parameters in the present set-up over to each of the set-ups 1 to 4.

3.2.8 0-6* Password

Define password access to menus.

0-60 Main Menu Password

Range:	Function:
100 N/A* [0 - 999 N/A]	Define the password for access to the Main Menu via the [Main Menu] key. If par. 0-61 <i>Access to Main Menu w/o Password</i> is set to <i>Full access</i> [0], this parameter will be ignored.

0-61 Access to Main Menu w/o Password

Option:	Function:
[0] * Full access	Disables password defined in par. 0-60 <i>Main Menu Password</i> .
[1] Read only	Prevent unauthorized editing of Main Menu parameters.
[2] No access	Prevent unauthorized viewing and editing of Main Menu parameters.
[16] All: No access	

If *Full access* [0] is selected then par. 0-60 *Main Menu Password*, par. 0-65 *Personal Menu Password* and par. 0-66 *Access to Personal Menu w/o Password* will be ignored.

0-65 Personal Menu Password

Range:

200 N/A* [0 - 999 N/A]

Function:

Define the password for access to the My Personal Menu via the [Quick Menu] key. If par. 0-66 *Access to Personal Menu w/o Password* is set to *Full access* [0], this parameter will be ignored.

0-66 Access to Personal Menu w/o Password

Option:

[0] * Full access

Function:

Disables password defined in par. 0-65 *Personal Menu Password*.

[1] Read only

Prevents unauthorized editing of My Personal Menu parameters.

[2] No access

Prevents unauthorized viewing and editing of My Personal Menu parameters.

[16] All: No access

If par. 0-61 *Access to Main Menu w/o Password* is set to *Full access* [0], this parameter will be ignored.

3.2.9 Clock Settings, 0-7*

Set the time and date of the internal clock. The internal clock can be used for e.g. Timed Actions, energy log, Trend Analysis, date/time stamps on alarms, Logged data and Preventive Maintenance.

It is possible to program the clock for Daylight Saving Time / summertime, weekly working days/non-working days including 20 exceptions (holidays etc.). Although the clock settings can be set via the LCP, they can also be set along with timed actions and preventative maintenance functions using the MCT10 software tool.



NB!

The frequency converter has no back up of the clock function and the set date/time will reset to default (2000-01-01 00:00) after a power down unless a Real Time Clock module with back up is installed. If no module with back up is installed, it is recommended the clock function is only used if the frequency converter is integrated into the BMS using serial communications, with the BMS maintaining synchronization of control equipment clock times. In par. 0-79 *Clock Fault* it is possible to program for a Warning in case clock has not been set properly, e.g. after a power down.



NB!

If mounting an Analog I/O MCB 109 option card, a battery back-up of the date and time is included.

0-70 Date and Time

Range:

0 N/A* [0 - 0 N/A]

Function:

Sets the date and time of the internal clock. The format to be used is set in par. 0-71 *Date Format* and par. 0-72 *Time Format*.

0-71 Date Format

Option:

[0] * YYYY-MM-DD

Function:

Sets the date format to be used in the LCP.

[1] DD-MM-YYYY

[2] MM/DD/YYYY

0-72 Time Format

Option: **Function:**

Sets the time format to be used in the LCP.

[0] * 24 h

[1] 12 h

0-74 DST/Summertime

Option: **Function:**

Choose how Daylight Saving Time/Summertime should be handled. For manual DST/Summertime enter the start date and end date in par. 0-76 *DST/Summertime Start* and par. 0-77 *DST/Summertime End*.

[0] * Off

[2] Manual

0-76 DST/Summertime Start

Range: **Function:**

0 N/A* [0 - 0 N/A]

Sets the date and time when summertime/DST starts. The date is programmed in the format selected in par. 0-71 *Date Format*.

0-77 DST/Summertime End

Range: **Function:**

0 N/A* [0 - 0 N/A]

Sets the date and time when summertime/DST ends. The date is programmed in the format selected in par. 0-71 *Date Format*.

0-79 Clock Fault

Option: **Function:**

Enables or disables the clock warning, when the clock has not been set or has been reset due to a power-down and no backup is installed.

[0] * Disabled

[1] Enabled

0-81 Working Days

Array with 7 elements [0] - [6] displayed below parameter number in display. Press OK and step between elements by means of ▲ and ▼ buttons on the LCP.

Option: **Function:**

Set for each weekday if it is a working day or a non-working day. First element of the array is Monday. The working days are used for Timed Actions.

[0] * No

[1] Yes

0-82 Additional Working Days

Array with 5 elements [0] - [4] displayed below parameter number in display. Press OK and step between elements by means of ▲ and ▼ buttons on the LCP.

Range: **Function:**

0 N/A* [0 - 0 N/A]

Defines dates for additional working days that normally would be non-working days according to par. 0-82 *Additional Working Days*.

0-83 Additional Non-Working Days

Array with 15 elements [0] - [14] displayed below parameter number in display. Press OK and step between elements by means of ▲ and ▼ buttons on the LCP.

Range:

0 N/A* [0 - 0 N/A]

Function:

Defines dates for additional working days that normally would be non-working days according to par. 0-81 *Working Days*.

0-89 Date and Time Readout

Range:

0 N/A* [0 - 0 N/A]

Function:

Displays the current date and time. The date and time is updated continuously. The clock will not begin counting until a setting different from default has been made in par. 0-70 *Date and Time*.

3.3 Main Menu - Load and Motor - Group 1

3.3.1 General Settings, 1-0*

Define whether the frequency converter operates in open loop or closed loop.

1-00 Configuration Mode

Option:

[0] * Open Loop

Function:

Motor speed is determined by applying a speed reference or by setting desired speed when in Hand Mode. Open Loop is also used if the frequency converter is part of a closed loop control system based on an external PID controller providing a speed reference signal as output.

[3] Closed Loop

Motor Speed will be determined by a reference from the built-in PID controller varying the motor speed as part of a closed loop control process (e.g. constant pressure or flow). The PID controller must be configured in par. 20-** or via the Function Setups accessed by pressing the [Quick Menus] button.

NB!
This parameter cannot be changed when motor is running.

NB!
When set for Closed Loop, the commands Reversing and Start Reversing will not reverse the direction of the motor.

1-03 Torque Characteristics

Option:

Function:

[0]	Compressor torque	<i>Compressor</i> [0]: For speed control of screw and scroll compressors. Provides a voltage which is optimized for a constant torque load characteristic of the motor in the entire range down to 10 Hz.
[1]	Variable torque	<i>Variable Torque</i> [1]: For speed control of centrifugal pumps and fans. Also to be used when controlling more than one motor from the same frequency converter (e.g. multiple condenser fans or cooling tower fans). Provides a voltage which is optimized for a squared torque load characteristic of the motor.
[2]	Auto Energy Optim. CT	<i>Auto Energy Optimization Compressor</i> [2]: For optimum energy efficient speed control of screw and scroll compressors. Provides a voltage which is optimized for a constant torque load characteristic of the motor in the entire range down to 15Hz but in addition the AEO feature will adapt the voltage exactly to the current load situation, thereby reducing energy consumption and audible noise from the motor. To obtain optimal performance, the motor power factor cos phi must be set correctly. This value is set in par. 14-43 <i>Motor Cosphi</i> . The parameter has a default value which is automatically adjusted when the motor data is programmed. These settings will typically ensure optimum motor voltage but if the motor power factor cos phi requires tuning, an AMA function can be carried out using par. 1-29 <i>Automatic Motor Adaptation (AMA)</i> . It is very rarely necessary to adjust the motor power factor parameter manually.
[3] *	Auto Energy Optim. VT	<i>Auto Energy Optimization VT</i> [3]: For optimum energy efficient speed control of centrifugal pumps and fans. Provides a voltage which is optimized for a squared torque load characteristic of the motor but in addition the AEO feature will adapt the voltage exactly to the current load situation, thereby reducing energy consumption and audible noise from the motor. To obtain optimal performance, the motor power factor cos phi must be set correctly. This value is set in par. 14-43 <i>Motor Cosphi</i> . The parameter has a default value and is automatically adjusted when the motor data is programmed. These settings will typically ensure optimum motor voltage but if the motor power factor cos phi requires tuning, an AMA function can be carried out using par. 1-29 <i>Automatic Motor Adaptation (AMA)</i> . It is very rarely necessary to adjust the motor power factor parameter manually.

3.3.2 1-2* Motor Data

Parameter group 1-2* comprises input data from the nameplate on the connected motor.

Parameters in parameter group 1-2* cannot be adjusted while the motor is running.



NB!

Changing the value of these parameters affects the setting of other parameters.

1-20 Motor Power [kW]

Range:

4.00 kW* [0.09 - 3000.00 kW]

Function:

Enter the nominal motor power in kW according to the motor nameplate data. The default value corresponds to the nominal rated output of the unit.

This parameter cannot be adjusted while the motor is running. Depending on the choices made in par. 0-03 *Regional Settings*, either par. 1-20 *Motor Power [kW]* or par. 1-21 *Motor Power [HP]* is made invisible.

1-21 Motor Power [HP]

Range:

4.00 hp* [0.09 - 3000.00 hp]

Function:

Enter the nominal motor power in HP according to the motor nameplate data. The default value corresponds to the nominal rated output of the unit.
 This parameter cannot be adjusted while the motor is running.
 Depending on the choices made in par. 0-03 *Regional Settings*, either par. 1-20 *Motor Power [kW]* or par. 1-21 *Motor Power [HP]* Motor Power is made invisible.

1-22 Motor Voltage

Range:

400. V* [10. - 1000. V]

Function:

Enter the nominal motor voltage according to the motor nameplate data. The default value corresponds to the nominal rated output of the unit.
 This parameter cannot be adjusted while the motor is running.

1-23 Motor Frequency

Range:

50. Hz* [20 - 1000 Hz]

Function:

Select the motor frequency value from the motor nameplate data. For 87 Hz operation with 230/400 V motors, set the nameplate data for 230 V/50 Hz. Adapt par. 4-13 *Motor Speed High Limit [RPM]* and par. 3-03 *Maximum Reference* to the 87 Hz application.



NB!

This parameter cannot be adjusted while the motor is running.

1-24 Motor Current

Range:

7.20 A* [0.10 - 10000.00 A]

Function:

Enter the nominal motor current value from the motor nameplate data. This data is used for calculating motor torque, motor thermal protection etc.



NB!

This parameter cannot be adjusted while the motor is running.

1-25 Motor Nominal Speed

Range:

1420. RPM* [100 - 60000 RPM]

Function:

Enter the nominal motor speed value from the motor nameplate data. This data is used for calculating automatic motor compensations.



NB!

This parameter cannot be changed while the motor is running.

1-28 Motor Rotation Check

Option:
Function:

Following installation and connection of the motor, this function allows the correct motor rotation direction to be verified. Enabling this function overrides any bus commands or digital inputs, except External Interlock and Safe Stop (if included).

[0] * Off

Motor Rotation Check is not active.

[1] Enabled

Motor Rotation Check is enabled. Once enabled, Display shows:
"Note! Motor may run in wrong direction".

Pressing [OK], [Back] or [Cancel] will dismiss the message and display a new message: "Press [Hand on] to start the motor. Press [Cancel] to abort". Pressing [Hand on] starts the motor at 5 Hz in forward direction and the display shows: "Motor is running. Check if motor rotation direction is correct. Press [Off] to stop the motor". Pressing [Off] stops the motor and resets par. 1-28 *Motor Rotation Check*. If motor rotation direction is incorrect, two motor phase cables should be interchanged. **IMPORTANT:**



Mains power must be removed before disconnecting motor phase cables.

1-29 Automatic Motor Adaptation (AMA)

Option:
Function:

The AMA function optimizes dynamic motor performance by automatically optimizing the advanced motor parameters par. 1-30 *Stator Resistance (Rs)* to par. 1-35 *Main Reactance (Xh)* while the motor is stationary.

[0] * Off

No function

[1] Enable complete AMA

performs AMA of the stator resistance R_s , the rotor resistance R_r , the stator leakage reactance X_{l1} , the rotor leakage reactance X_{l2} and the main reactance X_h .

[2] Enable reduced AMA

performs a reduced AMA of the stator resistance R_s in the system only. Select this option if an LC filter is used between the frequency converter and the motor.

Activate the AMA function by pressing [Hand on] after selecting [1] or [2]. See also the section *Automatic Motor Adaptation*. After a normal sequence, the display will read: "Press [OK] to finish AMA". After pressing the [OK] key the frequency converter is ready for operation.

Note:

- For the best adaptation of the frequency converter, run AMA on a cold motor
- AMA cannot be performed while the motor is running

NB!

It is important to set motor par. 1-2* Motor Data correctly, since these form part of the AMA algorithm. An AMA must be performed to achieve optimum dynamic motor performance. It may take up to 10 min., depending on motor power rating.

NB!

Avoid generating external torque during AMA

NB!
 If one of the settings in par. 1-2* Motor Data is changed, par. 1-30 *Stator Resistance (Rs)* to par. 1-39 *Motor Poles*, the advanced motor parameters, will return to default setting.
 This parameter cannot be adjusted while the motor is running

NB!
 Full AMA should be run without filter only while reduced AMA should be run with filter.

See section *Automatic Motor Adaptation* - application example.

3.3.3 1-3* Adv. Motor Data

Parameters for advanced motor data. The motor data in par. 1-30 *Stator Resistance (Rs)* to par. 1-39 *Motor Poles* must match the relevant motor in order to run the motor optimally. The default settings are figures based on common motor parameter values from normal standard motors. If the motor parameters are not set correctly, a malfunction of the frequency converter system may occur. If the motor data is not known, running an AMA (Automatic Motor Adaptation) is recommended. See the *Automatic Motor Adaptation* section. The AMA sequence will adjust all motor parameters except the moment of inertia of the rotor and the iron loss resistance (par. 1-36 *Iron Loss Resistance (Rfe)*).

Par. 1-3* and par. 1-4* cannot be adjusted while the motor is running.

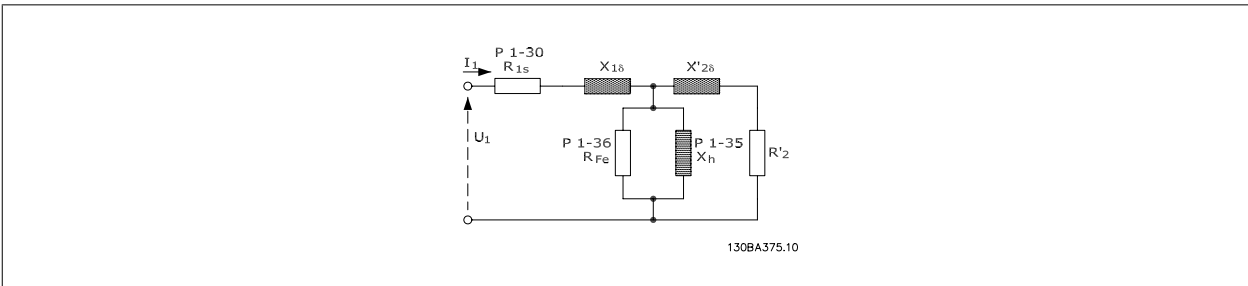

Illustration 3.1: Motor equivalent diagram for an asynchronous motor

1-30 Stator Resistance (Rs)

Range:	Function:
1.4000 [0.0140 - 140.0000 Ohm] Ohm*	Set the stator resistance value. Enter the value from a motor data sheet or perform an AMA on a cold motor. This parameter cannot be adjusted while the motor is running.

1-35 Main Reactance (Xh)

Range:	Function:
100.0000 [1.0000 - 10000.0000 Ohm] Ohm*	Set the main reactance of the motor using one of these methods: <ol style="list-style-type: none"> 1. Run an AMA on a cold motor. The frequency converter will measure the value from the motor. 2. Enter the X_h value manually. Obtain the value from the motor supplier. 3. Use the X_h default setting. The frequency converter establishes the setting on the basis of the motor name plate data.

NB!
 This parameter cannot be adjusted while running.

1-36 Iron Loss Resistance (R_{fe})**Range:**10000.000 [0 - 10000.000 Ohm]
Ohm***Function:**

Enter the equivalent iron loss resistance (R_{fe}) value to compensate for iron losses in the motor. The R_{fe} value cannot be found by performing an AMA.

The R_{fe} value is especially important in torque control applications. If R_{fe} is unknown, leave par. 1-36 *Iron Loss Resistance (R_{fe})* on default setting.

3

**NB!**

This parameter cannot be adjusted while the motor is running.

1-39 Motor Poles**Range:**

4. N/A* [2 - 100 N/A]

Function:

Enter the number of motor poles.

Poles	~n _n @ 50 Hz	~n _n @60 Hz
2	2700 - 2880	3250 - 3460
4	1350 - 1450	1625 - 1730
6	700 - 960	840 - 1153

The table shows the number of poles for normal speed ranges of various motor types. Define motors designed for other frequencies separately. The motor pole value is always an even number, because it refers to the total number of poles, not pairs of poles. The frequency converter creates the initial setting of par. 1-39 *Motor Poles* based on par. 1-23 *Motor Frequency Motor Frequency* and par. 1-25 *Motor Nominal Speed Motor Nominal Speed*.

This parameter cannot be adjusted while the motor is running.

3.3.4 1-5* Load Indep. Setting

Parameters for setting the load-independent motor settings.

1-50 Motor Magnetisation at Zero Speed**Range:**

100 %* [0 - 300 %]

Function:

Use this par. along with par. 1-51 *Min Speed Normal Magnetising [RPM]* to obtain a different thermal load on the motor when running at low speed.

Enter a value which is a percentage of the rated magnetizing current. If the setting is too low, the torque on the motor shaft may be reduced.

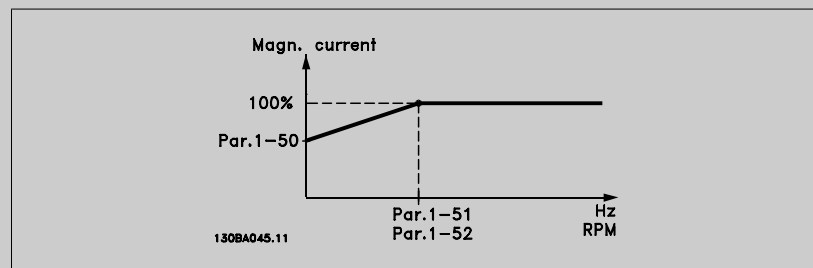
**1-51 Min Speed Normal Magnetising [RPM]****Range:**

15. RPM* [10 - 300 RPM]

Function:

Set the required speed for normal magnetising current. If the speed is set lower than the motor slip speed, par. 1-50 *Motor Magnetisation at Zero Speed* and par. 1-51 *Min Speed Normal Magnetising [RPM]* are of no significance.

Use this par. along with par. 1-50 *Motor Magnetisation at Zero Speed*. See drawing for par. 1-50 *Motor Magnetisation at Zero Speed*.

1-52 Min Speed Normal Magnetising [Hz]

Range:

0.5 Hz* [0.3 - 10.0 Hz]

Function:

Set the required frequency for normal magnetising current. If the frequency is set lower than the motor slip frequency, par. 1-50 *Motor Magnetisation at Zero Speed* and par. 1-51 *Min Speed Normal Magnetising [RPM]*, are inactive.

Use this par. along with par. 1-50 *Motor Magnetisation at Zero Speed*. See drawing for par. 1-50 *Motor Magnetisation at Zero Speed*.

3.3.5 1-6* Load Depend. Setting

Parameters for adjusting the load-dependent motor settings.

1-60 Low Speed Load Compensation

Range:

100 %* [0 - 300 %]

Function:

Enter the % value to compensate voltage in relation to load when the motor is running at low speed and obtain the optimum U/f characteristic. The motor size determines the frequency range within which this parameter is active.

Motor size	Change over
0.25 kW - 7.5 kW	< 10 Hz
11 kW - 45 kW	< 5 Hz
55 kW - 550 kW	< 3-4 Hz

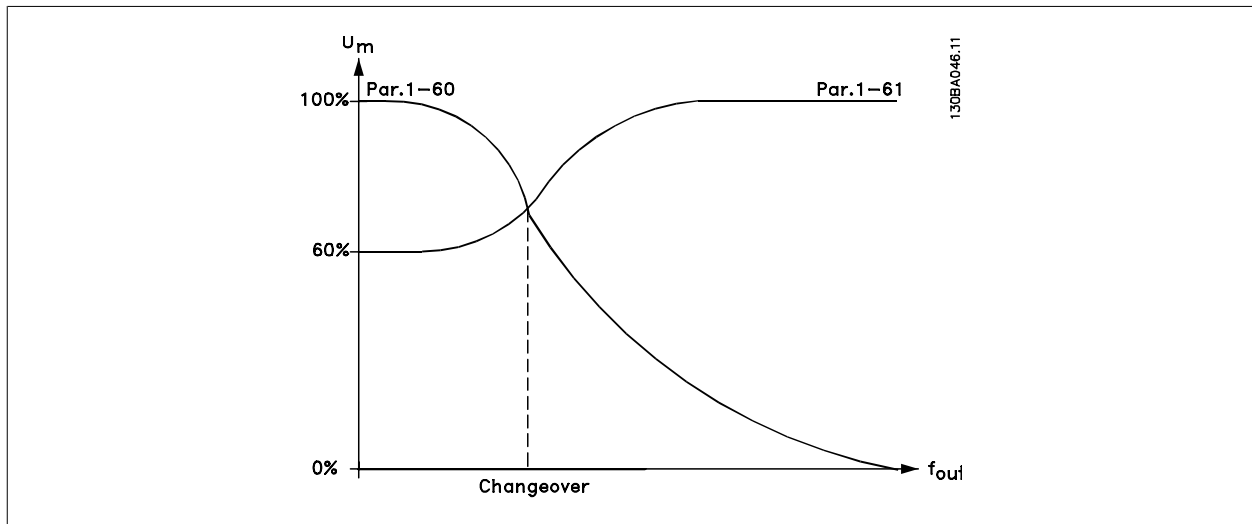

1-61 High Speed Load Compensation

Range:

100 %* [0 - 300 %]

Function:

Enter the % value to compensate voltage in relation to load when the motor is running at high speed and obtain the optimum U/f characteristic. The motor size determines the frequency range within which this parameter is active.

Motor size	Change-over
0.25 kW - 7.5 kW	> 10 Hz
11 kW - 45 kW	< 5 Hz
55 kW - 550 kW	< 3-4 Hz

1-62 Slip Compensation

Range:

0 %* [-500 - 500 %]

Function:

Enter the % value for slip compensation, to compensate for tolerances in the value of $n_{m,N}$. Slip compensation is calculated automatically, i.e. on the basis of the rated motor speed $n_{m,N}$.

1-63 Slip Compensation Time Constant**Range:**

0.10 s* [0.05 - 5.00 s]

Function:

Enter the slip compensation reaction speed. A high value results in slow reaction, and a low value results in quick reaction. If low-frequency resonance problems arise, use a longer time setting.

1-64 Resonance Dampening**Range:**

100 %* [0 - 500 %]

Function:

Enter the resonance dampening value. Set par. 1-64 *Resonance Dampening* and par. 1-65 *Resonance Dampening Time Constant* to help eliminate high-frequency resonance problems. To reduce resonance oscillation, increase the value of par. 1-64 *Resonance Dampening*.

1-65 Resonance Dampening Time Constant**Range:**

5 ms* [5 - 50 ms]

Function:

Set par. 1-64 *Resonance Dampening* and par. 1-65 *Resonance Dampening Time Constant* to help eliminate high-frequency resonance problems. Enter the time constant that provides the best dampening.

3.3.6 1-7* Start Adjustments

Parameters for setting special motor start features.

1-71 Start Delay**Range:**

0.0 s* [0.0 - 120.0 s]

Function:

The function selected in par. 1-80 *Function at Stop* is active in the delay period. Enter the time delay required before commencing acceleration.

1-73 Flying Start**Option:****Function:**

This function makes it possible to catch a motor which is spinning freely due to a mains drop-out. When par. 1-73 *Flying Start* is enabled, par. 1-71 *Start Delay* has no function. Search direction for flying start is linked to the setting in par. 4-10 *Motor Speed Direction*. *Clockwise* [0]: Flying start search in clockwise direction. If not successful, a DC brake is carried out. *Both Directions* [2]: The flying start will first make a search in the direction determined by the last reference (direction). If not finding the speed it will make a search in the other direction. If not successful, a DC brake will be activated in the time set in par. 2-02 *DC Braking Time*. Start will then take place from 0 Hz.

[0] * Disabled

Select *Disable* [0] if this function is not required

[1] Enabled

Select *Enable* [1] to enable the frequency converter to "catch" and control a spinning motor.**3.3.7 1-8* Stop Adjustments**

Parameters for setting special stop features for the motor.

1-80 Function at Stop**Option:****Function:**

Select the frequency converter function after a stop command or after the speed is ramped down to the settings in par. 1-81 *Min Speed for Function at Stop [RPM]*.

[0] * Coast

Leaves motor in free mode.

[1] DC Hold/Motor Preheat

Energizes motor with a DC holding current (see par. 2-00 *DC Hold/Preheat Current*).

1-81 Min Speed for Function at Stop [RPM]

Range:

3. RPM* [0 - 600 RPM]

Function:
Set the speed at which to activate par. 1-80 *Function at Stop*.

1-82 Min Speed for Function at Stop [Hz]

Range:

0.1 Hz* [0.0 - 20.0 Hz]

Function:
Set the output frequency at which to activate par. 1-80 *Function at Stop*.

3.3.8 Trip at Motor Speed Low Limit

In par. 4-11 *Motor Speed Low Limit [RPM]* and par. 4-12 *Motor Speed Low Limit [Hz]* it is possible to set a minimum speed for the motor in order to ensure proper oil distribution.

In some cases e.g. if operating in current limit because of a defect in the compressor, the output motor speed can be suppressed below Motor Speed Low Limit. To prevent damage to the compressor it is possible to set trip limit. If the motor speed drops below this limit, the frequency converter will trip and issue an alarm (A49).

Reset will take place according to the selected function in par. 14-20 *Reset Mode*.

If the trip must take place at a rather exact speed (RPM), it is recommended to set par. 0-02 *Motor Speed Unit* for RPM and use slip compensation, which can be set in par. 1-62 *Slip Compensation*.

NB!

To achieve the highest accuracy with the slip compensation, an Automatic Motor Adaptation (AMA) should be performed. To be enabled in par. 1-29 *Automatic Motor Adaptation (AMA)*.

NB!

Trip will not be active when using a normal stop- or coast command.

1-86 Trip Speed Low [RPM]

Range:

0 RPM* [0 - par. 4-13 RPM]

Function:

If the Trip Speed is set to 0, the function is not active.

NB!

This parameter is only available if par. 0-02 *Motor Speed Unit* is set to [RPM].

1-87 Trip Speed Low [Hz]

Range:

0.0 Hz* [0.0 - par. 4-14 Hz]

Function:

If the Trip Speed is set to 0, the function is not active.

NB!

This parameter is only available if par. 0-02 *Motor Speed Unit* is set to [RPM].

3.3.9 1-9* Motor Temperature

Parameters for setting the temperature protection features for the motor.

1-90 Motor Thermal Protection

Option:	Function:
	The frequency converter determines the motor temperature for motor protection in two different ways: <ul style="list-style-type: none"> Via a thermistor sensor connected to one of the analog or digital inputs (par. 1-93 <i>Thermistor Source</i>). Via calculation (ETR = Electronic Thermal Relay) of the thermal load, based on the actual load and time. The calculated thermal load is compared with the rated motor current $I_{M,N}$ and the rated motor frequency $f_{M,N}$. The calculations estimate the need for a lower load at lower speed due to less cooling from the fan incorporated in the motor.
[0]	No protection If the motor is continuously overloaded and no warning or trip of frequency converter is wanted.
[1]	Thermistor warning Activates a warning when the connected thermistor in the motor reacts in the event of motor over-temperature.
[2]	Thermistor trip Stops (trips) the frequency converter when the connected thermistor in the motor reacts in the event of motor over-temperature.
[3]	ETR warning 1
[4] *	ETR trip 1
[5]	ETR warning 2
[6]	ETR trip 2
[7]	ETR warning 3
[8]	ETR trip 3
[9]	ETR warning 4
[10]	ETR trip 4

ETR (Electronic Thermal Relay) functions 1-4 will calculate the load when set-up where they were selected is active. For example ETR-3 starts calculating when set-up 3 is selected. For the North American market: The ETR functions provide class 20 motor overload protection in accordance with NEC.

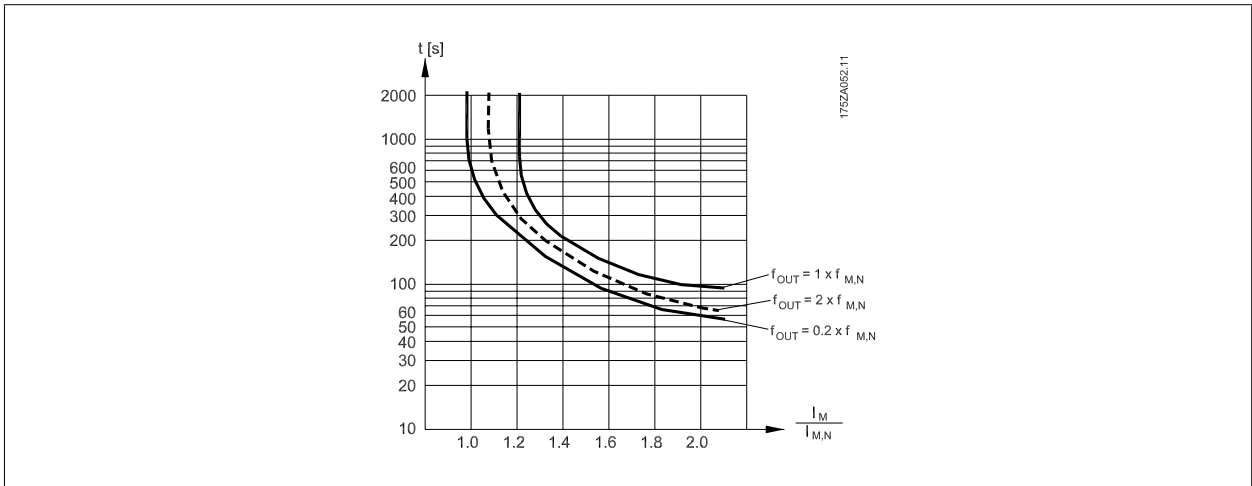

NB!
Danfoss recommends using 24 VDC as thermistor supply voltage.

1-91 Motor External Fan

Option:

- [0] * No
- [1] Yes

Function:

No external fan is required, i.e. the motor is derated at low speed.

Applies an external motor fan (external ventilation), so no derating of the motor is required at low speed. The graph below is followed if the motor current is lower than nominal motor current (see par. 1-24 *Motor Current*). If the motor current exceeds nominal current, the operation time still decreases as if no fan were installed.

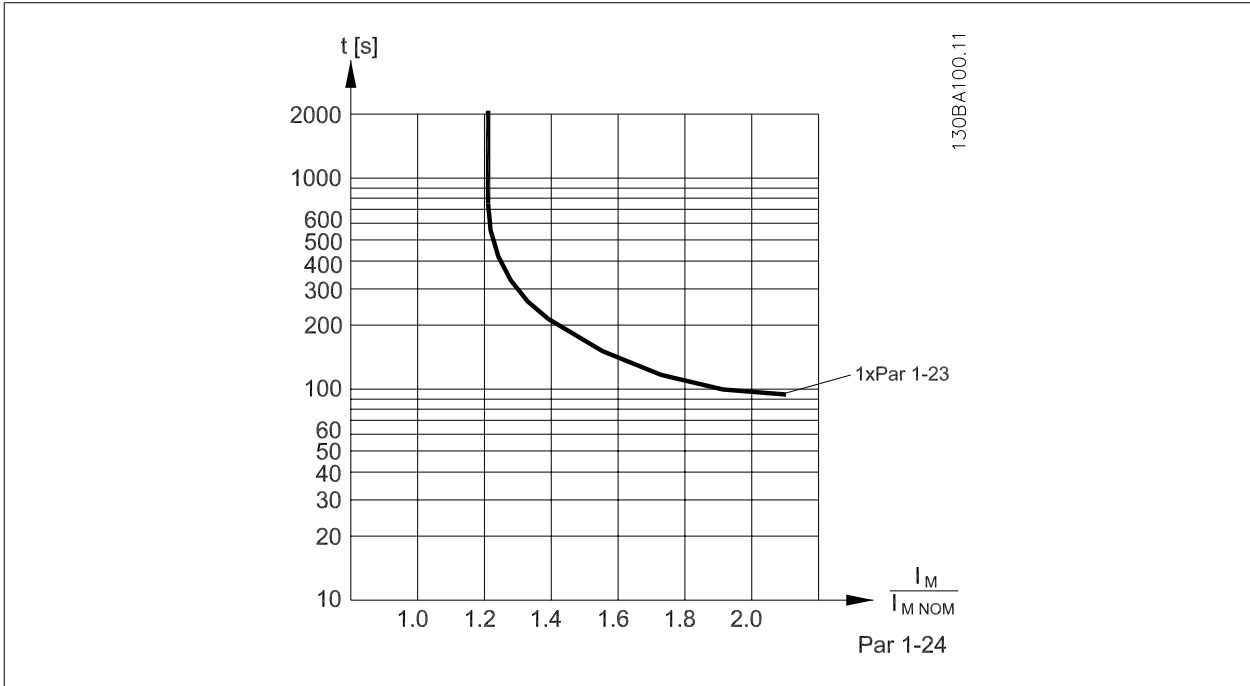

3

1-93 Thermistor Source

Option:

- [0] * None
- [1] Analog input 53
- [2] Analog input 54
- [3] Digital input 18
- [4] Digital input 19
- [5] Digital input 32
- [6] Digital input 33

Function:

Select the input to which the thermistor (PTC sensor) should be connected. An analog input option [1] or [2] cannot be selected if the analog input is already in use as a reference source (selected in par. 3-15 *Reference 1 Source*, par. 3-16 *Reference 2 Source* or par. 3-17 *Reference 3 Source*). When using MCB112, choice [0] *None* must always be selected.

NB!
This parameter cannot be adjusted while the motor is running.

NB!
Digital inputs should be set to "No operation" - see par. 5-1*.

3.4 Main Menu - Brakes - Group 2

3.4.1 2-0* DC-Brakes

Parameter group for configuring the DC brake and DC hold functions.

3

2-00 DC Hold/Preheat Current

Range:

50 %* [0 - 160. %]

Function:

Enter a value for holding current as a percentage of the rated motor current $I_{M,N}$ set in par. 1-24 *Motor Current*. 100% DC holding current corresponds to $I_{M,N}$.

This parameter holds the motor (holding torque) or pre-heats the motor.

This parameter is active if [1] DC hold/Preheat is selected in par. 1-80 *Function at Stop*.

NB!

The maximum value depends on the rated motor current.

NB!

Avoid 100 % current for too long. It may damage the motor.

2-01 DC Brake Current

Range:

50 %* [0 - 1000. %]

Function:

Enter a value for current as a percentage of the rated motor current $I_{M,N}$, see par. 1-24 *Motor Current*. 100% DC braking current corresponds to $I_{M,N}$.

DC brake current is applied on a stop command, when the speed is lower than the limit set in par. 2-03 *DC Brake Cut In Speed [RPM]*; when the DC Brake Inverse function is active; or via the serial communication port. The braking current is active during the time period set in par. 2-02 *DC Braking Time*.

NB!

The maximum value depends on the rated motor current.

NB!

Avoid 100 % current for too long. It may damage the motor.

2-02 DC Braking Time

Range:

10.0 s* [0.0 - 60.0 s]

Function:

Set the duration of the DC braking current set in par. 2-01 *DC Brake Current*, once activated.

2-03 DC Brake Cut In Speed [RPM]

Range:

0 RPM* [0 - par. 4-13 RPM]

Function:

Set the DC brake cut-in speed for activation of the DC braking current set in par. 2-01 *DC Brake Current*, upon a stop command.

3.4.2 2-1* Brake Energy Funct.

Parameter group for selecting dynamic braking parameters.

2-10 Brake Function

Option:

Function:

[0] *	Off	No brake resistor installed.
[1]	Resistor brake	Brake resistor incorporated in the system, for dissipation of surplus brake energy as heat. Connecting a brake resistor allows a higher DC link voltage during braking (generating operation). The Resistor brake function is only active in frequency converters with an integral dynamic brake.
[2]	AC brake	

2-11 Brake Resistor (ohm)

Range:

Function:

50. Ohm*	[5. - 32000. Ohm]	Set the brake resistor value in Ohms. This value is used for monitoring the power to the brake resistor in par. 2-13 <i>Brake Power Monitoring</i> . This parameter is only active in frequency converters with an integral dynamic brake. If the selection is xxxx use this parameter. If the selection is xxx.xx, use par. 3-81 <i>Quick Stop Ramp Time</i> .
----------	-------------------	--

2-12 Brake Power Limit (kW)

Range:

Function:

5.000 kW*	[0.001 - 500.000 kW]	Set the monitoring limit of the brake power transmitted to the resistor. The monitoring limit is a product of the maximum duty cycle (120 sec.) and the maximum power of the brake resistor at that duty cycle. See the formula below.
-----------	----------------------	---

For 200 - 240 V units:	$P_{resistor} = \frac{390^2 \times dutytime}{R \times 120}$
For 380 - 480 V units	$P_{resistor} = \frac{778^2 \times dutytime}{R \times 120}$
For 380 - 500 V units	$P_{resistor} = \frac{810^2 \times dutytime}{R \times 120}$
For 575 - 600 V units	$P_{resistor} = \frac{943^2 \times dutytime}{R \times 120}$

This parameter is only active in frequency converters with an integral dynamic brake.

2-13 Brake Power Monitoring

Option:

Function:

		This parameter is only active in frequency converters with an integral dynamic brake. This parameter enables monitoring of the power to the brake resistor. The power is calculated on the basis of the resistance (par. 2-11 <i>Brake Resistor (ohm)</i> (Ohm)), the DC link voltage, and the resistor duty time.
[0] *	Off	No brake power monitoring is required.
[1]	Warning	Activates a warning on the display when the power transmitted over 120 s exceeds 100% of the monitoring limit (par. 2-12 <i>Brake Power Limit (kW)</i>). The warning disappears when the transmitted power falls below 80% of the monitoring limit.
[2]	Trip	Trips the frequency converter and displays an alarm when the calculated power exceeds 100% of the monitoring limit.
[3]	Warning and trip	Activates both of the above, including warning, trip and alarm.

If power monitoring is set to *Off*[0] or *Warning*[1], the brake function remains active even if the monitoring limit is exceeded. This may lead to thermal overload of the resistor. It is also possible to generate a warning via a relay/digital output. The measuring accuracy of the power monitoring depends on the accuracy of the resistance of the resistor (better than ± 20%).

2-15 Brake Check

Option:

Function:

Select type of test and monitoring function to check the connection to the brake resistor, or whether a brake resistor is present, and then display a warning or an alarm in the event of a fault. The brake resistor disconnection function is tested during power-up. However the brake IGBT test is performed when there is no braking. A warning or trip disconnects the brake function.

The testing sequence is as follows:

1. The DC link ripple amplitude is measured for 300 ms without braking.
2. The DC link ripple amplitude is measured for 300 ms with the brake turned on.
3. If the DC link ripple amplitude while braking is lower than the DC link ripple amplitude before braking + 1 %. Brake check failed, return a warning or alarm.
4. If the DC link ripple amplitude while braking is higher than the DC link ripple amplitude before braking + 1 %. Brake check OK.

[0] *	Off	Monitors brake resistor and brake IGBT for a short-circuit during operation. If a short-circuit occurs, a warning appears.
[1]	Warning	Monitors brake resistor and brake IGBT for a short-circuit, and to run a test for brake resistor disconnection during power-up
[2]	Trip	Monitors for a short-circuit or disconnection of the brake resistor, or a short-circuit of the brake IGBT. If a fault occurs the frequency converter cuts out while displaying an alarm (trip locked).
[3]	Stop and trip	Monitors for a short-circuit or disconnection of the brake resistor, or a short-circuit of the brake IGBT. If a fault occurs the frequency converter ramps down to coast and then trips. A trip lock alarm is displayed.
[4]	AC brake	



NB!

NB!: Remove a warning arising in connection with *Off*[0] or *Warning* [1] by cycling the mains supply. The fault must be corrected first. For *Off*[0] or *Warning* [1], the frequency converter keeps running even if a fault is located.

2-17 Over-voltage Control

Option:

Function:

Over-voltage control (OVC) reduces the risk of the frequency converter tripping due to an over voltage on the DC link caused by generative power from the load.

[0]	Disabled	No OVC required.
[2] *	Enabled	Activates OVC.



NB!

The ramp time is automatically adjusted to avoid tripping of the frequency converter.

3.5 Main Menu - Reference/Ramps - Group 3

3.5.1 3-0* Reference Limits

Parameters for setting the reference unit, limits and ranges.

Please see also par. 20-0* for information on settings in closed loop.

3-02 Minimum Reference

Range:

0.000 Ref- [-999999.999 - par. 3-03 ReferenceFeed-ceFeedbackUnit] backUnit*

Function:

Enter the desired minimum value for the remote reference. The Minimum Reference value and unit matches the configuration choice made in par. 1-00 *Configuration Mode* and par. 20-12 *Reference/Feedback Unit*, respectively.



NB!

If operating with par. 1-00, Configuration Mode set for Closed Loop [3], par. 20-13, Minimum Reference/Feedb. must be used.

3-03 Maximum Reference

Range:

50.000 Ref- [par. 3-02 - 999999.999 ReferenceFeed-ceFeedbackUnit] backUnit*

Function:

Enter the maximum acceptable value for the remote reference. The Maximum Reference value and unit matches the configuration choice made in par. 1-00 *Configuration Mode* and par. 20-12 *Reference/Feedback Unit*, respectively.



NB!

If operating with par. 1-00, Configuration Mode set for Closed Loop [3], par. 20-14, Maximum Reference/Feedb. must be used.

3-04 Reference Function

Option:

- [0] * Sum
- [1] External/Preset

Function:

- Sums both external and preset reference sources.
- Use either the preset or the external reference source.

Shift between external and preset via a command on a digital input.

3.5.2 3-1* References

Parameters for setting up the reference sources.

Select the preset reference(s). *Select Preset ref. bit 0 / 1 / 2* [16], [17] or [18] for the corresponding digital inputs in parameter group 5.1*.

3-10 Preset Reference

Array [8]

Range:

0.00 %* [-100.00 - 100.00 %]

Function:

Enter up to eight different preset references (0-7) in this parameter, using array programming. The preset reference is stated as a percentage of the value Ref_{MAX} (par. 3-03 *Maximum Reference*, for closed loop see par. 20-14 *Maximum Reference/Feedb.*). When using preset references, select Preset ref. bit 0 / 1 / 2 [16], [17] or [18] for the corresponding digital inputs in parameter group 5-1* Digital Inputs.

3

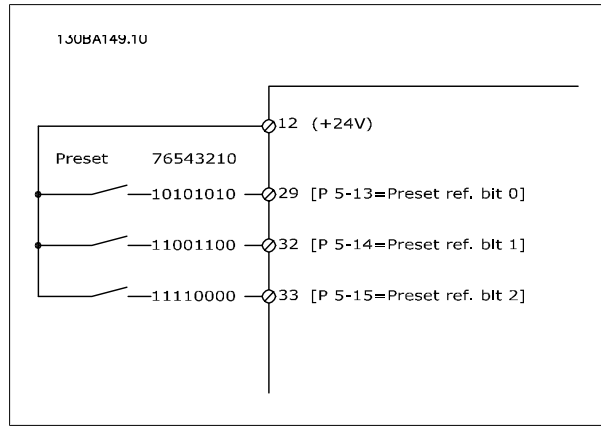
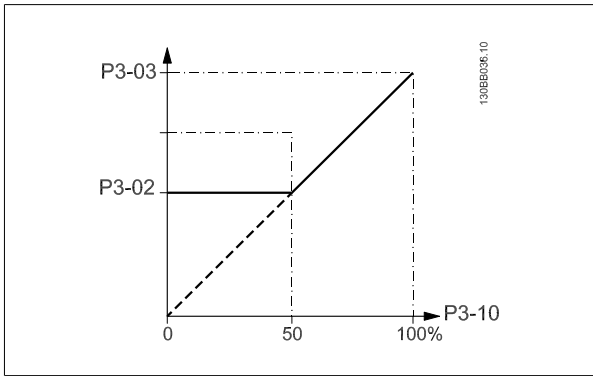

3-11 Jog Speed [Hz]

Range:	Function:
10.0 Hz* [0.0 - par. 4-14 Hz]	The jog speed is a fixed output speed at which the frequency converter is running when the jog function is activated. See also par. 3-80 <i>Jog Ramp Time</i> .

3-13 Reference Site

Option:	Function:
	Select which reference site to activate.
[0] * Linked to Hand / Auto	Use local reference when in Hand mode; or remote reference when in Auto mode.
[1] Remote	Use remote reference in both Hand mode and Auto mode.
[2] Local	Use local reference in both Hand mode and Auto mode.

NB!
When set to Local [2], the frequency converter will start with this setting again following a 'power down'.

3-14 Preset Relative Reference

Range:	Function:
0.00 %* [-100.00 - 100.00 %]	The actual reference, X, is increased or decreased with the percentage Y, set in par. 3-14 <i>Preset Relative Reference</i> . This results in the actual reference Z. Actual reference (X) is the sum of the inputs selected in par. 3-15 <i>Reference 1 Source</i> , par. 3-16 <i>Reference 2 Source</i> , par. 3-17 <i>Reference 3 Source</i> and par. 8-02 <i>Control Source</i> .

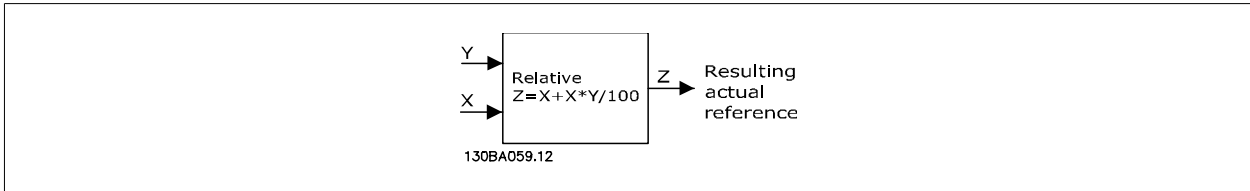

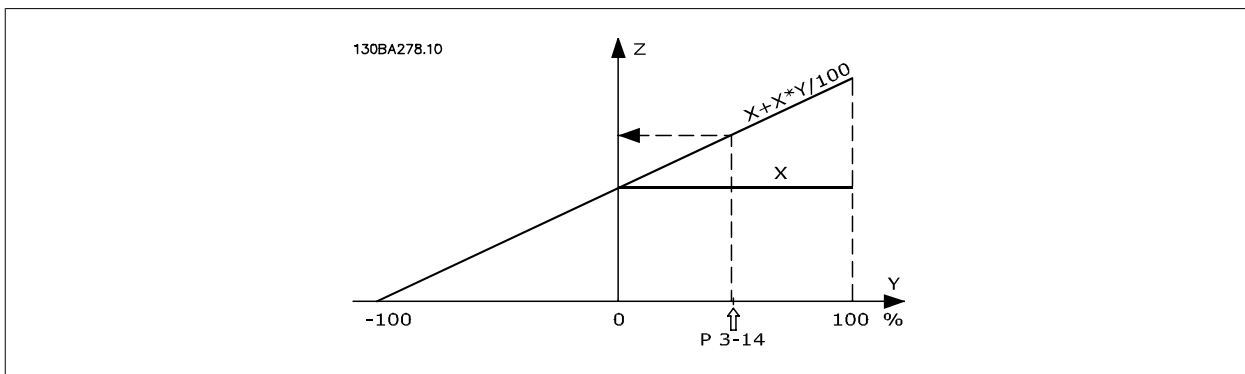

3-15 Reference 1 Source

Option:

Function:

Select the reference input to be used for the first reference signal. par. 3-15 *Reference 1 Source*, par. 3-16 *Reference 2 Source* and par. 3-17 *Reference 3 Source* define up to three different reference signals. The sum of these reference signals defines the actual reference.

This parameter cannot be adjusted while the motor is running.

[0] No function

[1] * Analog input 53

[2] Analog input 54

[7] Pulse input 29

[8] Pulse input 33

[20] Digital pot.meter

[21] Analog input X30/11

[22] Analog input X30/12

[23] Analog Input X42/1

[24] Analog Input X42/3

[25] Analog Input X42/5

[30] Ext. Closed Loop 1

[31] Ext. Closed Loop 2

[32] Ext. Closed Loop 3

3-16 Reference 2 Source

Option:**Function:**

Select the reference input to be used for the second reference signal. par. 3-15 *Reference 1 Source*, par. 3-16 *Reference 2 Source* and par. 3-17 *Reference 3 Source* define up to three different reference signals. The sum of these reference signals defines the actual reference.

This parameter cannot be adjusted while the motor is running.

[0]	No function
[1]	Analog input 53
[2]	Analog input 54
[7]	Pulse input 29
[8]	Pulse input 33
[20] *	Digital pot.meter
[21]	Analog input X30/11
[22]	Analog input X30/12
[23]	Analog Input X42/1
[24]	Analog Input X42/3
[25]	Analog Input X42/5
[30]	Ext. Closed Loop 1
[31]	Ext. Closed Loop 2
[32]	Ext. Closed Loop 3

3-17 Reference 3 Source

Option:**Function:**

Select the reference input to be used for the third reference signal. par. 3-15 *Reference 1 Source*, par. 3-16 *Reference 2 Source* and par. 3-17 *Reference 3 Source* define up to three different reference signals. The sum of these reference signals defines the actual reference.

This parameter cannot be adjusted while the motor is running.

[0] *	No function
[1]	Analog input 53
[2]	Analog input 54
[7]	Pulse input 29
[8]	Pulse input 33
[20]	Digital pot.meter
[21]	Analog input X30/11
[22]	Analog input X30/12
[23]	Analog Input X42/1
[24]	Analog Input X42/3
[25]	Analog Input X42/5
[30]	Ext. Closed Loop 1
[31]	Ext. Closed Loop 2
[32]	Ext. Closed Loop 3

3-19 Jog Speed [RPM]

Range:**Function:**

300. RPM* [0 - par. 4-13 RPM]

Enter a value for the jog speed n_{JOG} , which is a fixed output speed. The frequency converter runs at this speed when the jog speed is activated. The maximum limit is defined in par. . See also par. 3-80 *Jog Ramp Time*.

3.5.3 3-4* Ramp 1

Configure the ramp parameter, ramping times, for each of the two ramps (par. 3-4* and par. 3-5*).

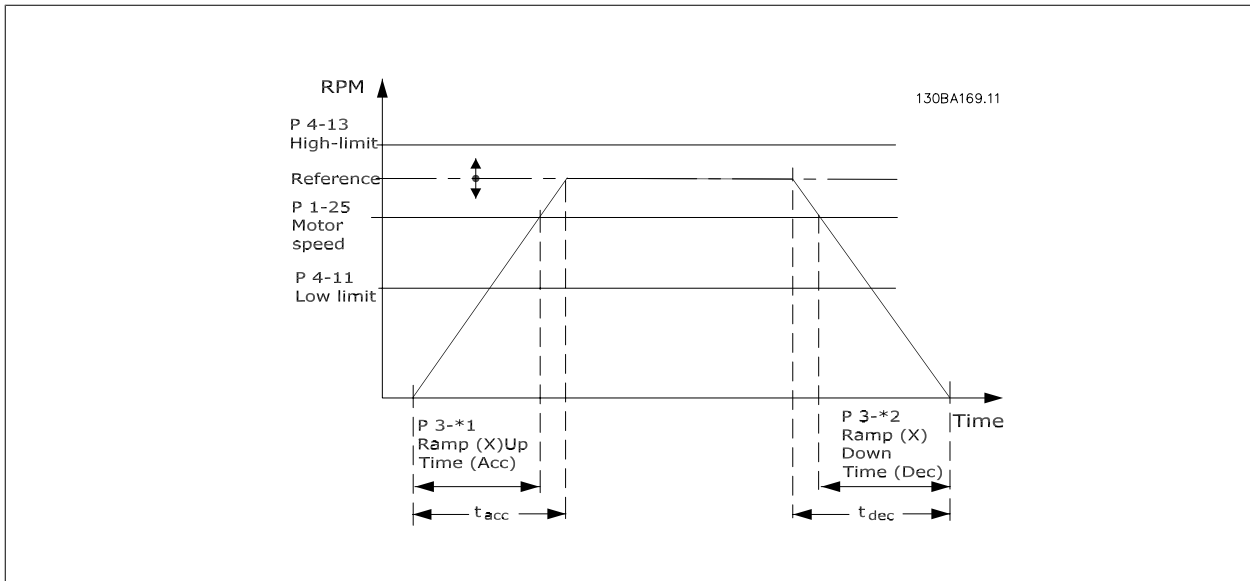

3

3-41 Ramp 1 Ramp Up Time

Range:

10.00 s* [1.00 - 3600.00 s]

Function:

Enter the ramp-up time, i.e. the acceleration time from 0 RPM to par. 1-25 *Motor Nominal Speed*. Choose a ramp-up time such that the output current does not exceed the current limit in par. 4-18 *Current Limit* during ramping. See ramp-down time in par. 3-42 *Ramp 1 Ramp Down Time*.

$$par.3 - 41 = \frac{t_{acc} \times n_{norm} [par.1 - 25]}{ref[rpm]} [s]$$

3-42 Ramp 1 Ramp Down Time

Range:

20.00 s* [1.00 - 3600.00 s]

Function:

Enter the ramp-down time, i.e. the deceleration time from par. 1-25 *Motor Nominal Speed* to 0 RPM. Choose a ramp-down time such that no over-voltage arises in the inverter due to regenerative operation of the motor, and such that the generated current does not exceed the current limit set in par. 4-18 *Current Limit*. See ramp-up time in par. 3-41 *Ramp 1 Ramp Up Time*.

$$par.3 - 42 = \frac{t_{dec} \times n_{norm} [par.1 - 25]}{ref[rpm]} [s]$$

3.5.4 3-5* Ramp 2

Choosing ramp parameters, see 3-4*.

3-51 Ramp 2 Ramp Up Time

Range:

10.00 s* [1.00 - 3600.00 s]

Function:

Enter the ramp-up time, i.e. the acceleration time from 0 RPM to par. 1-25 *Motor Nominal Speed*. Choose a ramp-up time such that the output current does not exceed the current limit in par. 4-18 *Current Limit* during ramping. See ramp-down time in par. 3-52 *Ramp 2 Ramp Down Time*.

$$par.3 - 51 = \frac{t_{acc} \times n_{norm} [par.1 - 25]}{ref[rpm]} [s]$$

3-52 Ramp 2 Ramp Down Time

Range:

20.00 s* [1.00 - 3600.00 s]

Function:

Enter the ramp-down time, i.e. the deceleration time from par. 1-25 *Motor Nominal Speed* to 0 RPM. Choose a ramp-down time such that no over-voltage arises in the inverter due to regenerative operation of the motor, and such that the generated current does not exceed the current limit set in par. 4-18 *Current Limit*. See ramp-up time in par. 3-51 *Ramp 2 Ramp Up Time*.

$$par.3 - 52 = \frac{t_{dec} \times n_{norm}[par.1 - 25]}{ref[rpm]} [s]$$

3

3.5.5 3-8* Other Ramps

Configure parameters for special ramps e.g. Jog or Quick Stop.

3-80 Jog Ramp Time

Range:

20.00 s* [1.00 - 3600.00 s]

Function:

Enter the jog ramp time, i.e. the acceleration/deceleration time between 0 RPM and the rated motor speed ($n_{M,N}$) (set in par. 1-25 *Motor Nominal Speed*). Ensure that the resultant output current required for the given jog ramp time does not exceed the current limit in par. 4-18 *Current Limit*. The jog ramp time starts upon activation of a jog signal via the control panel, a selected digital input, or the serial communication port.

$$par.3 - 80 = \frac{t_{jog} \times n_{norm}[par.1 - 25]}{jog\ speed[par.3 - 19]} [s]$$

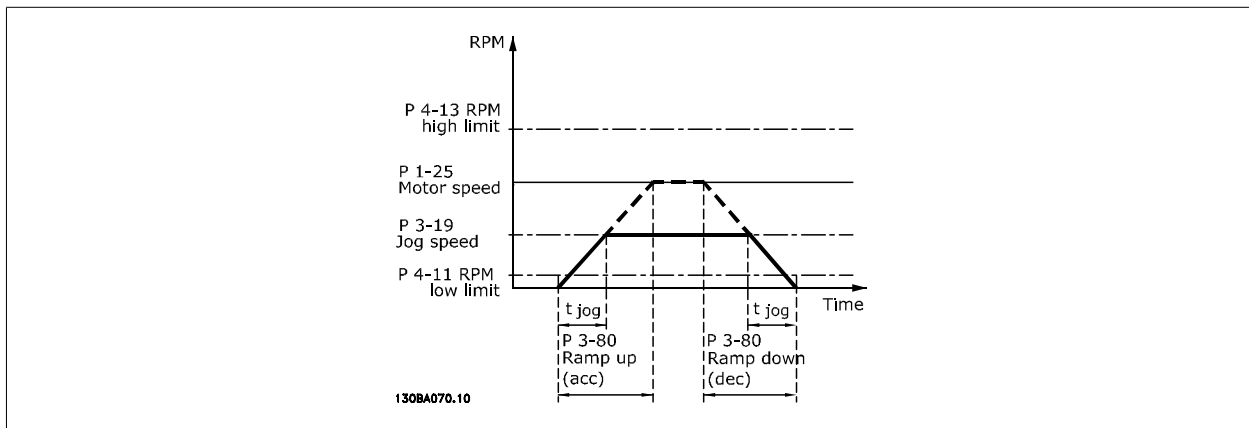

3.5.6 3-9* Digital Pot.Meter

The digital potentiometer function allows the user to increase or decrease the actual reference by adjusting the set-up of the digital inputs using the functions INCREASE, DECREASE or CLEAR. To activate the function, at least one digital input must be set up to INCREASE or DECREASE.

3-90 Step Size

Range:

0.10 %* [0.01 - 200.00 %]

Function:

Enter the increment size required for INCREASE/DECREASE, as a percentage of the synchronous motor speed, n_s . If INCREASE/ DECREASE is activated the resulting reference will be increased / decreased by the amount set in this parameter.

3-91 Ramp Time

Range:

1.00 s* [0.00 - 3600.00 s]

Function:

Enter the ramp time, i.e. the time for adjustment of the reference from 0% to 100% of the specified digital potentiometer function (INCREASE, DECREASE or CLEAR).

If INCREASE / DECREASE is activated for longer than the ramp delay specified in par. 3-95 *Ramp Delay* the actual reference will be ramped up / down according to this ramp time. The ramp time is defined as the time used to adjust the reference by the step size specified in par. 3-90 *Step Size*.

3-92 Power Restore

Option:

[0] * Off

Function:

Resets the Digital Potentiometer reference to 0% after power up.

[1] On

Restores the most recent Digital Potentiometer reference at power up.

3-93 Maximum Limit

Range:

100 %* [-200 - 200 %]

Function:

Set the maximum permissible value for the resultant reference. This is advisable if the Digital Potentiometer is used for fine tuning of the resulting reference.

3-94 Minimum Limit

Range:

0 %* [-200 - 200 %]

Function:

Set the minimum permissible value for the resultant reference. This is advisable if the Digital Potentiometer is used for fine tuning of the resulting reference.

3-95 Ramp Delay

Range:

1.000 N/A* [0.000 - 3600.000 N/A]

Function:

Enter the delay required from activation of the digital potentiometer function until the frequency converter starts to ramp the reference. With a delay of 0 ms, the reference starts to ramp as soon as INCREASE / DECREASE is activated. See also par. 3-91 *Ramp Time*.

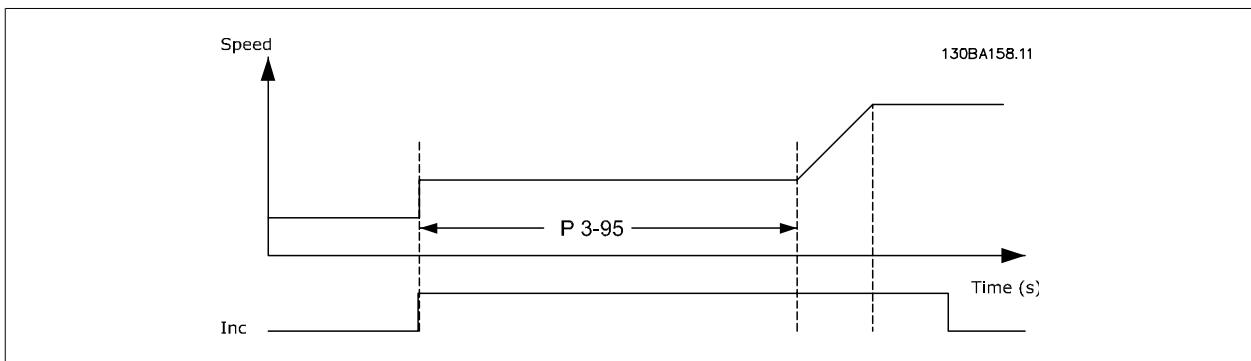

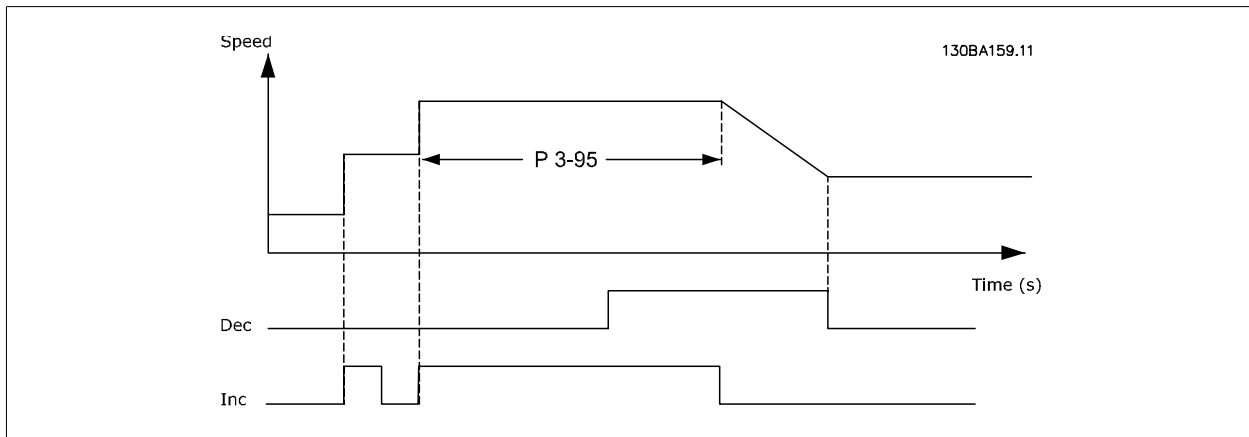

3.6 Main Menu - Limits/Warnings - Group 4

3.6.1 4-** Limits and Warnings

Parameter group for configuring limits and warnings.

3.6.2 4-1* Motor Limits

Define torque, current and speed limits for the motor, and the reaction of the frequency converter when the limits are exceeded.

A limit may generate a message on the display. A warning will always generate a message on the display or on the fieldbus. A monitoring function may initiate a warning or a trip, upon which the frequency converter will stop and generate an alarm message.

4-10 Motor Speed Direction

Option:

Function:

Selects the motor speed direction required.
Use this parameter to prevent unwanted reversing.

[0] Clockwise

Only operation in clockwise direction will be allowed.

[2]* Both directions

Operation in both clockwise and anti-clockwise direction will be allowed.



NB!

The setting in par. 4-10 *Motor Speed Direction* has impact on the Flying Start in par. 1-73 *Flying Start*.

4-11 Motor Speed Low Limit [RPM]

Range:

0 RPM* [0 - par. 4-13 RPM]

Function:

Enter the minimum limit for motor speed. The Motor Speed Low Limit can be set to correspond to the manufacturer's recommended minimum motor speed. The Motor Speed Low Limit must not exceed the setting in par. 4-13 *Motor Speed High Limit [RPM]*.

4-12 Motor Speed Low Limit [Hz]

Range:

0 Hz* [0 - par. 4-14 Hz]

Function:

Enter the minimum limit for motor speed. The Motor Speed Low Limit can be set to correspond to the minimum output frequency of the motor shaft. The Speed Low Limit must not exceed the setting in par. 4-14 *Motor Speed High Limit [Hz]*.

4-13 Motor Speed High Limit [RPM]

Range:

1500. RPM* [par. 4-11 - 60000. RPM]

Function:

Enter the maximum limit for motor speed. The Motor Speed High Limit can be set to correspond to the manufacturer's maximum rated motor. The Motor Speed High Limit must exceed the setting in par. 4-11 *Motor Speed Low Limit [RPM]*. Only par. 4-11 *Motor Speed Low Limit [RPM]* or par. 4-12 *Motor Speed Low Limit [Hz]* will be displayed depending on other parameters in the Main Menu and depending on default settings dependant on global location.

NB!

The output frequency value of the frequency converter must not exceed a value higher than 1/10 of the switching frequency.

NB!

Any changes in par. 4-13 *Motor Speed High Limit [RPM]* will reset the value in par. 4-53 *Warning Speed High* to the same value as set in par. 4-13 *Motor Speed High Limit [RPM]*.

4-14 Motor Speed High Limit [Hz]

Range:

 50/60.0 [par. 4-12 - par. 4-19 Hz]
Hz*

Function:

Enter the maximum limit for motor speed. The Motor Speed High Limit can be set to correspond to the manufacturer's recommended maximum of the motor shaft. The Motor Speed High Limit must exceed the in par. 4-12 *Motor Speed Low Limit [Hz]*. Only par. 4-11 *Motor Speed Low Limit [RPM]* or par. 4-12 *Motor Speed Low Limit [Hz]* will be displayed depending on other parameters in the Main Menu and depending on default settings dependant on global location.

NB!

Max. output frequency cannot exceed 10% of the inverter switching frequency (par. 14-01 *Switching Frequency*).

4-16 Torque Limit Motor Mode

Range:

110.0 %* [0.0 - 1000.0 %]

Function:

Enter the maximum torque limit for motor operation. The torque limit is active in the speed range up to and including the rated motor speed set in par. 1-25 *Motor Nominal Speed*. To protect the motor from reaching the stalling torque, the default setting is 1.1 x the rated motor torque (calculated value). See also par. 14-25 *Trip Delay at Torque Limit* for further details.
If a setting in par. 1-00 *Configuration Mode* to par. 1-28 *Motor Rotation Check* is changed, par. 4-16 *Torque Limit Motor Mode* is not automatically reset to the default setting.

4-17 Torque Limit Generator Mode

Range:

100.0 %* [0.0 - 1000.0 %]

Function:

Enter the maximum torque limit for generator mode operation. The torque limit is active in the speed range up to and including the rated motor speed (par. 1-25 *Motor Nominal Speed*). Refer to par. 14-25 *Trip Delay at Torque Limit* for further details.
If a setting in par. 1-00 *Configuration Mode* to par. 1-28 *Motor Rotation Check* is changed, par. 4-17 *Torque Limit Generator Mode* is not automatically reset to the default settings.

4-18 Current Limit

Range:

110.0 %* [1.0 - 1000.0 %]

Function:

Enter the current limit for motor and generator operation. To protect the motor from reaching the stalling torque, the default setting is 1.1 x the rated motor current (set in par. 1-24 *Motor Current*). If a setting in par. 1-00 *Configuration Mode* to par. 1-28 *Motor Rotation Check* is changed, par. 4-16 *Torque Limit Motor Mode* to par. 4-18 *Current Limit* are not automatically reset to the default settings.

4-19 Max Output Frequency

Range:

100.0 Hz* [1.0 - 1000.0 Hz]

Function:

Enter the maximum output frequency value. par. 4-19 *Max Output Frequency* specifies the absolute limit on the frequency converter output frequency for improved safety in applications where accidental over-speeding must be avoided. This absolute limit applies to all configurations and is independent of the setting in par. 1-00 *Configuration Mode*. This parameter cannot be adjusted while the motor is running.

3.6.3 4-5* Adj. Warnings

Define adjustable warning limits for current, speed, reference and feedback.



NB!

Not visible in display, only in VLT Motion Control Tool, MCT 10.

Warnings are shown on display, programmed output or serial bus.

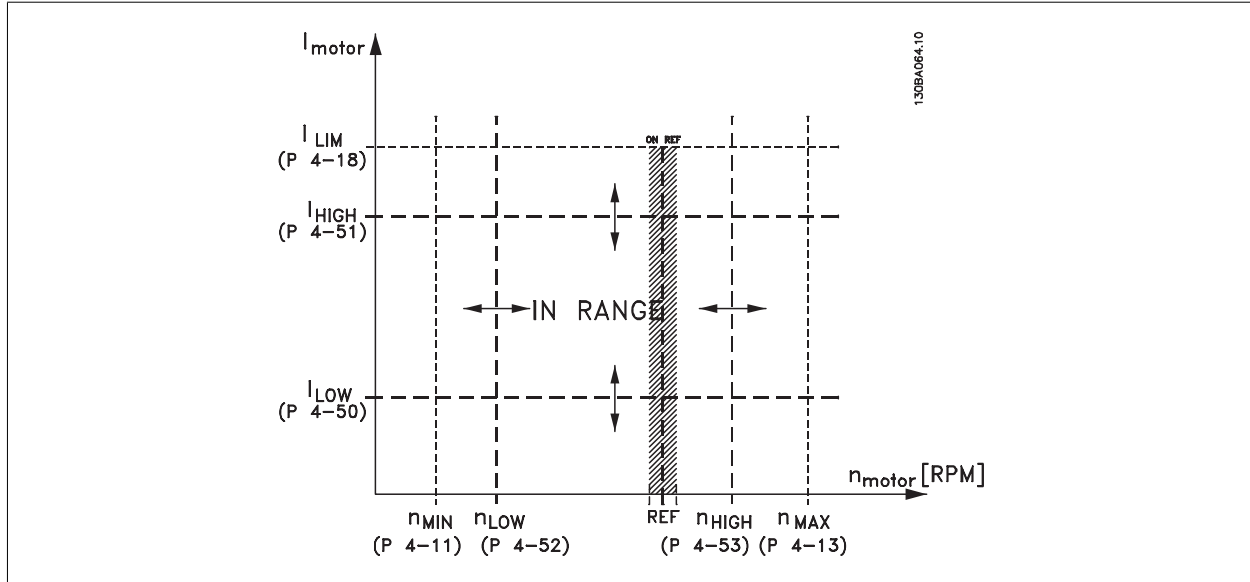

4-50 Warning Current Low

Range:

0.00 A* [0.00 - par. 4-51 A]

Function:

Enter the I_{LOW} value. When the motor current falls below this limit (I_{LOW}), the display reads CURRENT LOW. The signal outputs can be programmed to produce a status signal on terminal 27 or 29 and on relay output 01 or 02. Refer to the drawing in this section.

4-51 Warning Current High

Range:

 par. 16-37 [par. 4-50 - par. 16-37 A]
A*

Function:

 Enter the I_{HIGH} value. When the motor current exceeds this limit (I_{HIGH}), the display reads CURRENT HIGH. The signal outputs can be programmed to produce a status signal on terminal 27 or 29 and on relay output 01 or 02. Refer to the drawing in this section.

4-52 Warning Speed Low

Range:

0 RPM* [0 - par. 4-53 RPM]

Function:

 Enter the n_{LOW} value. When the motor speed falls below this limit (n_{LOW}) the display reads SPEED LOW. The signal outputs can be programmed to produce a status signal on terminal 27 or 29 and on relay output 01 or 02. Programme the lower signal limit of the motor speed, n_{LOW} , within the normal working range of the frequency converter. Refer to the drawing in this section.

4-53 Warning Speed High

Range:

 par. 4-13 [par. 4-52 - par. 4-13 RPM]
RPM*

Function:

 Enter the n_{HIGH} value. When the motor speed exceeds this limit (n_{HIGH}), the display reads SPEED HIGH. The signal outputs can be programmed to produce a status signal on terminal 27 or 29 and on relay output 01 or 02. Programme the upper signal limit of the motor speed, n_{HIGH} , within the normal working range of the frequency converter. Refer to the drawing in this section.

NB!

 Any changes in par. 4-13 *Motor Speed High Limit [RPM]* will reset the value in par. 4-53 *Warning Speed High* to the same value as set in par. 4-13 *Motor Speed High Limit [RPM]*.

 If a different value is needed in par. 4-53 *Warning Speed High*, it must be set after programming of par. 4-13 *Motor Speed High Limit [RPM]*.

4-54 Warning Reference Low

Range:

 -999999.99 [-999999.999 - par. 4-55 N/A]
9 N/A*

Function:

Enter the lower reference limit. When the actual reference falls below this limit, the display indicates Ref Low. The signal outputs can be programmed to produce a status signal on terminal 27 or 29 and on relay output 01 or 02.

4-55 Warning Reference High

Range:

 999999.999 [par. 4-54 - 999999.999 N/A]
N/A*

Function:

Enter the upper reference limit. When the actual reference exceeds this limit, the display reads Ref High. The signal outputs can be programmed to produce a status signal on terminal 27 or 29 and on relay output 01 or 02.

4-56 Warning Feedback Low

Range:

 -999999.99 [-999999.999 - par. 4-57 Proc-
9 Proc-essCtrlUnit]
essCtrlU-
nit*

Function:

Enter the lower feedback limit. When the feedback falls below this limit, the display reads Feedb Low. The signal outputs can be programmed to produce a status signal on terminal 27 or 29 and on relay output 01 or 02.

4-57 Warning Feedback High

Range:

 999999.999 [par. 4-56 - 999999.999 ProcessCtr-
ProcessCtr- IUnit]
IUnit*

Function:

Enter the upper feedback limit. When the feedback exceeds this limit, the display reads Feedb High. The signal outputs can be programmed to produce a status signal on terminal 27 or 29 and on relay output 01 or 02.

4-58 Missing Motor Phase Function

Option:
Function:

Displays an alarm in the event of a missing motor phase.

Select 100 ms to have a short detection time and alarm in the event of a missing motor phase. 100 ms is recommended for hoisting applications.

[0] Off

No alarm is displayed if a missing motor phase occurs.

[1] * On

An alarm is displayed if a missing motor phase occurs.

NB!

This parameter cannot be adjusted while the motor is running.

3.6.4 4-6* Speed Bypass

Define the Speed Bypass areas for the ramps.

Some systems call for avoiding certain output frequencies or speeds, due to resonance problems in the system. A maximum of four frequency or speed ranges can be avoided.

4-60 Bypass Speed From [RPM]

Array [4]

Range:
Function:

0 RPM* [0 - par. 4-13 RPM]

Some systems call for avoiding certain output speeds due to resonance problems in the system. Enter the lower limits of the speeds to be avoided.

4-61 Bypass Speed From [Hz]

Array [4]

Range:
Function:

0 Hz* [0.0 - par. 4-14 Hz]

Some systems call for avoiding certain output speeds due to resonance problems in the system. Enter the lower limits of the speeds to be avoided.

4-62 Bypass Speed To [RPM]

Array [4]

Range:
Function:

0 RPM* [0 - par. 4-13 RPM]

Some systems call for avoiding certain output speeds due to resonance problems in the system. Enter the upper limits of the speeds to be avoided.

4-63 Bypass Speed To [Hz]

Array [4]

Range:
Function:

0 Hz* [0.0 - par. 4-14 Hz]

Some systems call for avoiding certain output speeds due to resonance problems in the system. Enter the upper limits of the speeds to be avoided.

3.6.5 Semi-Automatic Bypass Speed Set-up

The Semi-Automatic Bypass Speed Setup can be used to facilitate the programming of the frequencies to be skipped due to resonances in the system.

The following process is to be carried out:

1. Stop the motor.

2. Select Enabled in par. 4-64 *Semi-Auto Bypass Set-up*.
3. Press *Hand On* on the Local Control Panel to start the search for frequency bands causing resonances. The motor will ramp up according to the ramp set.
4. When sweeping through a resonance band, press *OK* on the Local Control Panel when leaving the band. The actual frequency will be stored as the first element in par. 4-62 *Bypass Speed To [RPM]* or par. 4-63 *Bypass Speed To [Hz]* (array). Repeat this for each resonance band identified at the ramp up (maximum four can be adjusted).
5. When maximum speed has been reached, the motor will automatically begin to ramp down. Repeat the above procedure when speed is leaving the resonance bands during the deceleration. The actual frequencies registered when pressing *OK* will be stored in par. 4-60 *Bypass Speed From [RPM]* or par. 4-61 *Bypass Speed From [Hz]*.
6. When the motor has ramped down to stop, press *OK*. The par. 4-64 *Semi-Auto Bypass Set-up* will automatically reset to Off. The frequency converter will stay in *Hand On* mode until *Off* or *Auto On* are pressed on the LCP.

If the frequencies for a certain resonance band are not registered in the right order (frequency values stored in *By Pass Speed To* are higher than those in *By Pass Speed From*) or if they do not have the same numbers of registrations for the *By Pass From* and *By Pass To*, all registrations will be cancelled and the following message is displayed: *Collected speed areas overlapping or not completely determined. Press [Cancel] to abort.*

4-64 Semi-Auto Bypass Set-up

Option:	Function:
[0] * Off	No function
[1] Enabled	Starts the Semi-Automatic Bypass set-up and continue with the procedure described above.

3.7 Main Menu - Digital In/Out - Group 5

3.7.1 5-** Digital In/Out

Parameter group for configuring the digital input and output.

3.7.2 5-0* Digital I/O Mode

Parameters for configuring the input and output using NPN and PNP.

5-00 Digital I/O Mode

Option:	Function:
	Digital inputs and programmed digital outputs are pre-programmable for operation either in PNP or NPN systems.
[0] * PNP - Active at 24V	Action on positive directional pulses (0). PNP systems are pulled down to GND.
[1] NPN - Active at 0V	Action on negative directional pulses (1). NPN systems are pulled up to + 24 V, internally in the frequency converter.



NB!

This parameter cannot be adjusted while the motor is running.

5-01 Terminal 27 Mode

Option:	Function:
[0] * Input	Defines terminal 27 as a digital input.
[1] Output	Defines terminal 27 as a digital output.

Please note that this parameter cannot be adjusted while the motor is running.

5-02 Terminal 29 Mode

Option:	Function:
[0] * Input	Defines terminal 29 as a digital input.
[1] Output	Defines terminal 29 as a digital output.

This parameter cannot be adjusted while the motor is running.

3

3.7.3 5-1* Digital Inputs

Parameters for configuring the input functions for the input terminals.

The digital inputs are used for selecting various functions in the frequency converter. All digital inputs can be set to the following functions:

Digital input function	Select	Terminal
No operation	[0]	All *terminal 19, 32, 33
Reset	[1]	All
Coast inverse	[2]	27
Coast and reset inverse	[3]	All
DC-brake inverse	[5]	All
Stop inverse	[6]	All
External interlock	[7]	All
Start	[8]	All *terminal 18
Latched start	[9]	All
Reversing	[10]	All
Start reversing	[11]	All
Jog	[14]	All *terminal 29
Preset reference on	[15]	All
Preset ref bit 0	[16]	All
Preset ref bit 1	[17]	All
Preset ref bit 2	[18]	All
Freeze reference	[19]	All
Freeze output	[20]	All
Speed up	[21]	All
Speed down	[22]	All
Set-up select bit 0	[23]	All
Set-up select bit 1	[24]	All
Pulse input	[32]	terminal 29, 33
Ramp bit 0	[34]	All
Mains failure inverse	[36]	All
Fire mode	[37]	All
Run Permissive	[52]	All
Hand start	[53]	All
Auto start	[54]	All
DigiPot Increase	[55]	All
DigiPot Decrease	[56]	All
DigiPot Clear	[57]	All
Counter A (up)	[60]	29, 33
Counter A (down)	[61]	29, 33
Reset Counter A	[62]	All
Counter B (up)	[63]	29, 33
Counter B (down)	[64]	29, 33
Reset Counter B	[65]	All
Sleep Mode	[66]	All
Reset Maintenance Word	[78]	All
Lead Pump Start	[120]	All
Lead Pump Alternation	[121]	All
Pump 1 Interlock	[130]	All
Pump 2 Interlock	[131]	All
Pump 3 Interlock	[132]	All

3.7.4 Digital Inputs, 5-1* continued

All = Terminals 18, 19, 27, 29, 32, 33, X30/2, X30/3, X30/4. X30/ are the terminals on MCB 101.

Functions dedicated to only one digital input are stated in the associated parameter.

All digital inputs can be programmed to these functions:

[0]	No operation	No reaction to signals transmitted to terminal.																																				
[1]	Reset	Resets frequency converter after a TRIP/ALARM. Not all alarms can be reset.																																				
[2]	Coast inverse	Leaves motor in free mode. Logic '0' => coasting stop. (Default Digital input 27): Coasting stop, inverted input (NC).																																				
[3]	Coast and reset inverse	Reset and coasting stop Inverted input (NC). Leaves motor in free mode and resets the frequency converter. Logic '0' => coasting stop and reset.																																				
[5]	DC-brake inverse	Inverted input for DC braking (NC). Stops motor by energizing it with a DC current for a certain time period. See par. 2-01 <i>DC Brake Current</i> to par. 2-03 <i>DC Brake Cut In Speed [RPM]</i> . The function is only active when the value in par. 2-02 <i>DC Braking Time</i> is different from 0. Logic '0' => DC braking.																																				
[6]	Stop inverse	Stop Inverted function. Generates a stop function when the selected terminal goes from logical level '1' to '0'. The stop is performed according to the selected ramp time (par. 3-42 <i>Ramp 1 Ramp Down Time</i> , par. 3-52 <i>Ramp 2 Ramp Down Time</i> , par. 3-62, par. 3-72).																																				
<div style="display: flex; align-items: center;"> <div> <p>NB!</p> <p>When the frequency converter is at the torque limit and has received a stop command, it may not stop by itself. To ensure that the frequency converter stops, configure a digital output to <i>Torque limit & stop</i> [27] and connect this digital output to a digital input that is configured as coast.</p> </div> </div>																																						
[7]	External Interlock	Same function as Coasting stop, inverse, but External Interlock generates the alarm message 'external fault' on the display when the terminal which is programmed for Coast Inverse is logic '0'. The alarm message will also be active via digital outputs and relay outputs, if programmed for External Interlock. The alarm can be reset using a digital input or the [RESET] key if the cause for the External Interlock has been removed. A delay can be programmed in par. 22-00 <i>External Interlock Delay</i> , External Interlock Time. After applying a signal to the input, the reaction described above will be delayed with the time set in par. 22-00 <i>External Interlock Delay</i> .																																				
[8]	Start	Select start for a start/stop command. Logic '1' = start, logic '0' = stop. (Default Digital input 18)																																				
[9]	Latched start	Motor starts, if a pulse is applied for min. 2 ms. Motor stops when Stop inverse is activated																																				
[10]	Reversing	Changes direction of motor shaft rotation. Select Logic '1' to reverse. The reversing signal only changes the direction of rotation. It does not activate the start function. Select both directions in par. 4-10 <i>Motor Speed Direction</i> . (Default Digital input 19).																																				
[11]	Start reversing	Used for start/stop and for reversing on the same wire. Signals on start are not allowed at the same time.																																				
[14]	Jog	Used for activating jog speed. See par. 3-11 <i>Jog Speed [Hz]</i> . (Default Digital input 29)																																				
[15]	Preset reference on	Used for shifting between external reference and preset reference. It is assumed that <i>External/preset</i> [1] has been selected in par. 3-04 <i>Reference Function</i> . Logic '0' = external reference active; logic '1' = one of the eight preset references is active.																																				
[16]	Preset ref bit 0	Enables a choice between one of the eight preset references according to the table below.																																				
[17]	Preset ref bit 1	Enables a choice between one of the eight preset references according to the table below.																																				
[18]	Preset ref bit 2	Enables a choice between one of the eight preset references according to the table below.																																				
<table border="1" style="width: 100%; border-collapse: collapse;"> <thead> <tr> <th>Preset ref. bit</th> <th>2</th> <th>1</th> <th>0</th> </tr> </thead> <tbody> <tr> <td>Preset ref. 0</td> <td>0</td> <td>0</td> <td>0</td> </tr> <tr> <td>Preset ref. 1</td> <td>0</td> <td>0</td> <td>1</td> </tr> <tr> <td>Preset ref. 2</td> <td>0</td> <td>1</td> <td>0</td> </tr> <tr> <td>Preset ref. 3</td> <td>0</td> <td>1</td> <td>1</td> </tr> <tr> <td>Preset ref. 4</td> <td>1</td> <td>0</td> <td>0</td> </tr> <tr> <td>Preset ref. 5</td> <td>1</td> <td>0</td> <td>1</td> </tr> <tr> <td>Preset ref. 6</td> <td>1</td> <td>1</td> <td>0</td> </tr> <tr> <td>Preset ref. 7</td> <td>1</td> <td>1</td> <td>1</td> </tr> </tbody> </table>			Preset ref. bit	2	1	0	Preset ref. 0	0	0	0	Preset ref. 1	0	0	1	Preset ref. 2	0	1	0	Preset ref. 3	0	1	1	Preset ref. 4	1	0	0	Preset ref. 5	1	0	1	Preset ref. 6	1	1	0	Preset ref. 7	1	1	1
Preset ref. bit	2	1	0																																			
Preset ref. 0	0	0	0																																			
Preset ref. 1	0	0	1																																			
Preset ref. 2	0	1	0																																			
Preset ref. 3	0	1	1																																			
Preset ref. 4	1	0	0																																			
Preset ref. 5	1	0	1																																			
Preset ref. 6	1	1	0																																			
Preset ref. 7	1	1	1																																			
[19]	Freeze ref	Freezes actual reference. The frozen reference is now the point of enable/condition for Speed up and Speed down to be used. If Speed up/down is used, the speed change always follows ramp 2																																				

(par. 3-51 *Ramp 2 Ramp Up Time* and par. 3-52 *Ramp 2 Ramp Down Time*) in the range 0 - par. 3-03 *Maximum Reference*. (For closed loop see par. 20-14, *Maximum Reference/Feedb.*).

[20] Freeze output
Freezes actual motor frequency (Hz). The frozen motor frequency is now the point of enable/condition for Speed up and Speed down to be used. If Speed up/down is used, the speed change always follows ramp 2 (par. 3-51 *Ramp 2 Ramp Up Time* and par. 3-52 *Ramp 2 Ramp Down Time*) in the range 0 - par. 1-23 *Motor Frequency*.

**NB!**

When Freeze output is active, the frequency converter cannot be stopped via a low 'start [13]' signal. Stop the frequency converter via a terminal programmed for Coasting inverse [2] or Coast and reset, inverse [3].

[21] Speed up
For digital control of the up/down speed is desired (motor potentiometer). Activate this function by selecting either Freeze reference or Freeze output. When Speed up is activated for less than 400 msec. the resulting reference will be increased by 0.1 %. If Speed up is activated for more than 400 msec. the resulting reference will ramp according to Ramp 1 in par. 3-41 *Ramp 1 Ramp Up Time*.

[22] Speed down
Same as Speed up [21].

[23] Set-up select bit 0
Selects one of the four set-ups. Set par. 0-10 to Multi Set-up.

[24] Set-up select bit 1
Same as Set-up select bit 0 [23].
(Default Digital input 32)

[32] Pulse input
Select Pulse input when using a pulse sequence as either reference or feedback. Scaling is done in par. group 5-5*.

[34] Ramp bit 0
Select which ramp to use. Logic "0" will select ramp 1 while logic "1" will select ramp 2.

[36] Mains failure inverse
Select to activate function selected in par. 14-10 *Mains Failure*. Mains failure is active in the Logic "0" situation.

[37] Fire mode
A signal applied will put the frequency converter into Fire Mode and all other commands will be disregarded. See 24-0* *Fire Mode*.

[52] Run Permissive
The input terminal, for which the Run permissive has been programmed must be logic "1" before a start command can be accepted. Run permissive has a logic 'AND' function related to the terminal which is programmed for *START* [8], *Jog* [14] or *Freeze Output* [20], which means that in order to start running the motor, both conditions must be fulfilled. If Run Permissive is programmed on multiple terminals, Run permissive needs only be logic '1' on one of the terminals for the function to be carried out. The digital output signal for Run Request (*Start* [8], *Jog* [14] or *Freeze output* [20]) programmed in par. 5-3*, or par. 5-4*, will not be affected by Run Permissive.

[53] Hand start
A signal applied will put the frequency converter into Hand mode as if button *Hand On* on the LCP has been pressed and a normal stop command will be overridden. If disconnecting the signal, the motor will stop. To make any other start commands valid, another digital input must be assign to *Auto Start* and a signal applied to this. The *Hand On* and *Auto On* buttons on the LCP has no impact. The *Off* button on the LCP will override *Hand Start* and *Auto Start*. Press either the *Hand On* or *Auto On* button to make *Hand Start* and *Auto Start* active again. If no signal on neither *Hand Start* nor *Auto Start*, the motor will stop regardless of any normal Start command applied. If signal applied to both *Hand Start* and *Auto Start*, the function will be *Auto Start*. If pressing the *Off* button on the LCP the motor will stop regardless of signals on *Hand Start* and *Auto Start*.

[54] Auto start
A signal applied will put the frequency converter into Auto mode as if the LCP button *Auto On* has been pressed. See also *Hand Start* [53]

[55] DigiPot Increase
Uses the input as an INCREASE signal to the Digital Potentiometer function described in parameter group 3-9*

[56] DigiPot Decrease
Uses the input as a DECREASE signal to the Digital Potentiometer function described in parameter group 3-9*

[57] DigiPot Clear
Uses the input to CLEAR the Digital Potentiometer reference described in parameter group 3-9*

[60] Counter A (up)
(Terminal 29 or 33 only) Input for increment counting in the SLC counter.

[61] Counter A (down)
(Terminal 29 or 33 only) Input for decrement counting in the SLC counter.

[62] Reset Counter A
Input for reset of counter A.

[63] Counter B (up)
(Terminal 29 and 33 only) Input for increment counting in the SLC counter.

[64] Counter B (down)
(Terminal 29 and 33 only) Input for decrement counting in the SLC counter.

[65]	Reset Counter B	Input for reset of counter B.
[66]	Sleep Mode	Forces frequency converter into Sleep Mode (see par. 22-4*). Reacts on the rising edge of signal applied!
[78]	Reset Preventive Maintenance Word	Resets all data in par. 16-96 <i>Maintenance Word</i> to 0.

The below setting options are all related to the Cascade Controller. Wiring diagrams and settings for parameter, see group 25-** for more details.

[120]	Lead Pump Start	Starts/Stops the Lead Pump (controlled by the frequency converter). A start requires that also a System Start signal has been applied e.g. to one of the digital inputs set for <i>Start</i> [8]!
[121]	Lead Pump Alternation	Forces alternation of the lead pump in a Cascade Controller. par. 25-50 <i>Lead Pump Alternation</i> , must be set to either <i>At Command</i> [2] or <i>At Staging or At Command</i> [3]. par. 25-51 <i>Alternation Event</i> , can be set to any of the four options.

[130 - 138] Pump1 Interlock - Pump9 Interlock For the above 9 setting options, par. 25-10 must be set to *On* [1]. The function will also depend on the setting in par. 25-05 *Fixed Lead Pump*. If set to *No* [0], then Pump1 refers to the pump controlled by relay RELAY1 etc. If set to *Yes* [1], Pump1 refers to the pump controlled by the frequency converter only (without any of the build in relays involved) and Pump2 to the pump controlled by the relay RELAY1. Variable speed pump (lead) cannot be interlocked.
See below table:

Setting in Par. 5-1*	Setting in par. 25-06 <i>Number of Pumps</i>	
	[0] No	[1] Yes
[130] Pump1 Interlock	Controlled by RELAY1 (only if not lead pump)	Frequency Converter controlled (cannot be interlocked)
[131] Pump2 Interlock	Controlled by RELAY2	Controlled by RELAY1
[132] Pump3 Interlock	Controlled by RELAY3	Controlled by RELAY2
[133] Pump4 Interlock	Controlled by RELAY4	Controlled by RELAY3
[134] Pump5 Interlock	Controlled by RELAY5	Controlled by RELAY4
[135] Pump6 Interlock	Controlled by RELAY6	Controlled by RELAY5
[136] Pump7 Interlock	Controlled by RELAY7	Controlled by RELAY6
[137] Pump8 Interlock	Controlled by RELAY8	Controlled by RELAY7
[138] Pump9 Interlock	Controlled by RELAY9	Controlled by RELAY8

5-10 Terminal 18 Digital Input

Option:

Function:

[0]	No operation	
[1]	Reset	
[2]	Coast inverse	
[3]	Coast and reset inv	
[5]	DC-brake inverse	
[6]	Stop inverse	
[7]	External interlock	
[8] *	Start	Same options and functions as par. 5-1*, except for <i>Pulse input</i> .
[9]	Latched start	
[10]	Reversing	
[11]	Start reversing	
[14]	Jog	
[15]	Preset reference on	
[16]	Preset ref bit 0	
[17]	Preset ref bit 1	
[18]	Preset ref bit 2	



[19]	Freeze reference
[20]	Freeze output
[21]	Speed up
[22]	Speed down
[23]	Set-up select bit 0
[24]	Set-up select bit 1
[34]	Ramp bit 0
[36]	Mains failure inverse
[37]	Fire Mode
[52]	Run permissive
[53]	Hand start
[54]	Auto start
[55]	DigiPot increase
[56]	DigiPot decrease
[57]	DigiPot clear
[62]	Reset Counter A
[65]	Reset Counter B
[66]	Sleep Mode
[78]	Reset Maint. Word
[120]	Lead Pump Start
[121]	Lead Pump Alternation
[130]	Pump 1 Interlock
[131]	Pump 2 Interlock
[132]	Pump 3 Interlock

5-11 Terminal 19 Digital Input

Option:
Function:

[0] *	No operation	Same options and functions as par. 5-1*, except for <i>Pulse input</i> .
[1]	Reset	
[2]	Coast inverse	
[3]	Coast and reset inv	
[5]	DC-brake inverse	
[6]	Stop inverse	
[7]	External interlock	
[8]	Start	
[9]	Latched start	
[10]	Reversing	
[11]	Start reversing	
[14]	Jog	
[15]	Preset reference on	
[16]	Preset ref bit 0	
[17]	Preset ref bit 1	
[18]	Preset ref bit 2	
[19]	Freeze reference	
[20]	Freeze output	
[21]	Speed up	
[22]	Speed down	

[23]	Set-up select bit 0
[24]	Set-up select bit 1
[34]	Ramp bit 0
[36]	Mains failure inverse
[37]	Fire Mode
[52]	Run permissive
[53]	Hand start
[54]	Auto start
[55]	DigiPot increase
[56]	DigiPot decrease
[57]	DigiPot clear
[62]	Reset Counter A
[65]	Reset Counter B
[66]	Sleep Mode
[78]	Reset Maint. Word
[120]	Lead Pump Start
[121]	Lead Pump Alternation
[130]	Pump 1 Interlock
[131]	Pump 2 Interlock
[132]	Pump 3 Interlock

5-12 Terminal 27 Digital Input

Option:
Function:

Same options and functions as par. 5-1*, except for *Pulse input*.

[0] *	No operation
[1]	Reset
[2]	Coast inverse
[3]	Coast and reset inv
[5]	DC-brake inverse
[6]	Stop inverse
[7]	External interlock
[8]	Start
[9]	Latched start
[10]	Reversing
[11]	Start reversing
[14]	Jog
[15]	Preset reference on
[16]	Preset ref bit 0
[17]	Preset ref bit 1
[18]	Preset ref bit 2
[19]	Freeze reference
[20]	Freeze output
[21]	Speed up
[22]	Speed down
[23]	Set-up select bit 0
[24]	Set-up select bit 1
[34]	Ramp bit 0

[36]	Mains failure inverse
[37]	Fire Mode
[52]	Run permissive
[53]	Hand start
[54]	Auto start
[55]	DigiPot increase
[56]	DigiPot decrease
[57]	DigiPot clear
[62]	Reset Counter A
[65]	Reset Counter B
[66]	Sleep Mode
[78]	Reset Maint. Word
[120]	Lead Pump Start
[121]	Lead Pump Alternation
[130]	Pump 1 Interlock
[131]	Pump 2 Interlock
[132]	Pump 3 Interlock

5-13 Terminal 29 Digital Input

Option:	Function:
[0]	No operation
[1]	Reset
[2]	Coast inverse
[3]	Coast and reset inv
[5]	DC-brake inverse
[6]	Stop inverse
[7]	External interlock
[8]	Start
[9]	Latched start
[10]	Reversing
[11]	Start reversing
[14] *	Jog Same options and functions as par. 5-1*.
[15]	Preset reference on
[16]	Preset ref bit 0
[17]	Preset ref bit 1
[18]	Preset ref bit 2
[19]	Freeze reference
[20]	Freeze output
[21]	Speed up
[22]	Speed down
[23]	Set-up select bit 0
[24]	Set-up select bit 1
[30]	Counter input
[32]	Pulse input
[34]	Ramp bit 0
[36]	Mains failure inverse
[37]	Fire Mode

[52]	Run permissive
[53]	Hand start
[54]	Auto start
[55]	DigiPot increase
[56]	DigiPot decrease
[57]	DigiPot clear
[60]	Counter A (up)
[61]	Counter A (down)
[62]	Reset Counter A
[63]	Counter B (up)
[64]	Counter B (down)
[65]	Reset Counter B
[66]	Sleep Mode
[78]	Reset Maint. Word
[120]	Lead Pump Start
[121]	Lead Pump Alternation
[130]	Pump 1 Interlock
[131]	Pump 2 Interlock
[132]	Pump 3 Interlock

5-14 Terminal 32 Digital Input

Option:

Function:

[0] *	No operation	Same options and functions as par. 5-1*, except for <i>Pulse input</i> .
[1]	Reset	
[2]	Coast inverse	
[3]	Coast and reset inv	
[5]	DC-brake inverse	
[6]	Stop inverse	
[7]	External interlock	
[8]	Start	
[9]	Latched start	
[10]	Reversing	
[11]	Start reversing	
[14]	Jog	
[15]	Preset reference on	
[16]	Preset ref bit 0	
[17]	Preset ref bit 1	
[18]	Preset ref bit 2	
[19]	Freeze reference	
[20]	Freeze output	
[21]	Speed up	
[22]	Speed down	
[23]	Set-up select bit 0	
[24]	Set-up select bit 1	
[34]	Ramp bit 0	
[36]	Mains failure inverse	
[37]	Fire Mode	

[52]	Run permissive
[53]	Hand start
[54]	Auto start
[55]	DigiPot increase
[56]	DigiPot decrease
[57]	DigiPot clear
[62]	Reset Counter A
[65]	Reset Counter B
[66]	Sleep Mode
[78]	Reset Maint. Word
[120]	Lead Pump Start
[121]	Lead Pump Alternation
[130]	Pump 1 Interlock
[131]	Pump 2 Interlock
[132]	Pump 3 Interlock

5-15 Terminal 33 Digital Input

Option:

Function:

[0] *	No operation	Same options and functions as par. 5-1* Digital Inputs.
[1]	Reset	
[2]	Coast inverse	
[3]	Coast and reset inv	
[5]	DC-brake inverse	
[6]	Stop inverse	
[7]	External interlock	
[8]	Start	
[9]	Latched start	
[10]	Reversing	
[11]	Start reversing	
[14]	Jog	
[15]	Preset reference on	
[16]	Preset ref bit 0	
[17]	Preset ref bit 1	
[18]	Preset ref bit 2	
[19]	Freeze reference	
[20]	Freeze output	
[21]	Speed up	
[22]	Speed down	
[23]	Set-up select bit 0	
[24]	Set-up select bit 1	
[30]	Counter input	
[32]	Pulse input	
[34]	Ramp bit 0	
[36]	Mains failure inverse	
[37]	Fire Mode	
[52]	Run permissive	
[53]	Hand start	

[54]	Auto start
[55]	DigiPot increase
[56]	DigiPot decrease
[57]	DigiPot clear
[60]	Counter A (up)
[61]	Counter A (down)
[62]	Reset Counter A
[63]	Counter B (up)
[64]	Counter B (down)
[65]	Reset Counter B
[66]	Sleep Mode
[78]	Reset Maint. Word
[120]	Lead Pump Start
[121]	Lead Pump Alternation
[130]	Pump 1 Interlock
[131]	Pump 2 Interlock
[132]	Pump 3 Interlock

5-16 Terminal X30/2 Digital Input

Option:

Function:

[0] *	No operation	This parameter is active when option module MCB 101 is installed in the frequency converter. It has the same options and functions as par. 5-1* except for <i>Pulse input</i> [32].
-------	--------------	--

[1]	Reset
[2]	Coast inverse
[3]	Coast and reset inv
[5]	DC-brake inverse
[6]	Stop inverse
[7]	External interlock
[8]	Start
[9]	Latched start
[10]	Reversing
[11]	Start reversing
[14]	Jog
[15]	Preset reference on
[16]	Preset ref bit 0
[17]	Preset ref bit 1
[18]	Preset ref bit 2
[19]	Freeze reference
[20]	Freeze output
[21]	Speed up
[22]	Speed down
[23]	Set-up select bit 0
[24]	Set-up select bit 1
[34]	Ramp bit 0
[36]	Mains failure inverse
[37]	Fire Mode
[52]	Run permissive

[53]	Hand start
[54]	Auto start
[55]	DigiPot increase
[56]	DigiPot decrease
[57]	DigiPot clear
[62]	Reset Counter A
[65]	Reset Counter B
[66]	Sleep Mode
[78]	Reset Maint. Word
[120]	Lead Pump Start
[121]	Lead Pump Alternation
[130]	Pump 1 Interlock
[131]	Pump 2 Interlock
[132]	Pump 3 Interlock

5-17 Terminal X30/3 Digital Input

Option:	Function:
[0] *	No operation This parameter is active when option module MCB 101 is installed in the frequency converter. It has the same options and functions as par. 5-1* except for <i>Pulse input</i> [32].
[1]	Reset
[2]	Coast inverse
[3]	Coast and reset inv
[5]	DC-brake inverse
[6]	Stop inverse
[7]	External interlock
[8]	Start
[9]	Latched start
[10]	Reversing
[11]	Start reversing
[14]	Jog
[15]	Preset reference on
[16]	Preset ref bit 0
[17]	Preset ref bit 1
[18]	Preset ref bit 2
[19]	Freeze reference
[20]	Freeze output
[21]	Speed up
[22]	Speed down
[23]	Set-up select bit 0
[24]	Set-up select bit 1
[34]	Ramp bit 0
[36]	Mains failure inverse
[37]	Fire Mode
[52]	Run permissive
[53]	Hand start
[54]	Auto start
[55]	DigiPot increase

- [56] DigiPot decrease
- [57] DigiPot clear
- [62] Reset Counter A
- [65] Reset Counter B
- [66] Sleep Mode
- [78] Reset Maint. Word
- [120] Lead Pump Start
- [121] Lead Pump Alternation
- [130] Pump 1 Interlock
- [131] Pump 2 Interlock
- [132] Pump 3 Interlock

5-18 Terminal X30/4 Digital Input

Option:	Function:
[0] * No operation	This parameter is active when option module MCB 101 is installed in the frequency converter. It has the same options and functions as par. 5-1* except for <i>Pulse input</i> [32].

- [1] Reset
- [2] Coast inverse
- [3] Coast and reset inv
- [5] DC-brake inverse
- [6] Stop inverse
- [7] External interlock
- [8] Start
- [9] Latched start
- [10] Reversing
- [11] Start reversing
- [14] Jog
- [15] Preset reference on
- [16] Preset ref bit 0
- [17] Preset ref bit 1
- [18] Preset ref bit 2
- [19] Freeze reference
- [20] Freeze output
- [21] Speed up
- [22] Speed down
- [23] Set-up select bit 0
- [24] Set-up select bit 1
- [34] Ramp bit 0
- [36] Mains failure inverse
- [37] Fire Mode
- [52] Run permissive
- [53] Hand start
- [54] Auto start
- [55] DigiPot increase
- [56] DigiPot decrease
- [57] DigiPot clear
- [62] Reset Counter A

[65]	Reset Counter B
[66]	Sleep Mode
[78]	Reset Maint. Word
[120]	Lead Pump Start
[121]	Lead Pump Alternation
[130]	Pump 1 Interlock
[131]	Pump 2 Interlock
[132]	Pump 3 Interlock

3.7.5 5-3* Digital Outputs

Parameters for configuring the output functions for the output terminals. The 2 solid-state digital outputs are common for terminals 27 and 29. Set the I/O function for terminal 27 in par. 5-01 *Terminal 27 Mode* and set the I/O function for terminal 29 in par. 5-02 *Terminal 29 Mode*. These parameters cannot be adjusted while the motor is running.

		The digital outputs can be programmed with these functions:
[0]	No operation	<i>Default for all digital outputs and relay outputs</i>
[1]	Control ready	The control board receives supply voltage.
[2]	Drive ready	The frequency converter is ready for operation and applies a supply signal on the control board.
[3]	Drive ready / remote control	The frequency converter is ready for operation and is in Auto On mode.
[4]	Stand-by / no warning	The frequency converter is ready for operation. No start or stop command is been given (start/disable). There are no warnings.
[5]	Running	The motor is running.
[6]	Running / no warning	The output speed is higher than the speed set in par. 1-81 <i>Min Speed for Function at Stop [RPM]</i> . The motor is running and there are no warnings.
[8]	Run on reference / no warning	The motor runs at reference speed.
[9]	Alarm	An alarm activates the output. There are no warnings.
[10]	Alarm or warning	An alarm or a warning activates the output.
[11]	At torque limit	The torque limit set in par. 4-16 <i>Torque Limit Motor Mode</i> or par. 1-17 has been exceeded.
[12]	Out of current range	The motor current is outside the range set in par. 4-18 <i>Current Limit</i> .
[13]	Below current, low	The motor current is lower than set in par. 4-50 <i>Warning Current Low</i> .
[14]	Above current, high	The motor current is higher than set in par. 4-51 <i>Warning Current High</i> .
[15]	Out of speed range	The output speed is outside the range set in par. 4-52 <i>Warning Speed Low</i> and par. 4-53 <i>Warning Speed High</i> .
[16]	Below speed, low	The output speed is lower than the setting in par. 4-52 <i>Warning Speed Low</i> .
[17]	Above speed, high	The output speed is higher than the setting in par. 4-53 <i>Warning Speed High</i> .
[18]	Out of feedback range	The feedback is outside the range set in par. 4-56 <i>Warning Feedback Low</i> and par. 4-57 <i>Warning Feedback High</i> .
[19]	Below feedback low	The feedback is below the limit set in par. 4-56 <i>Warning Feedback Low</i> .
[20]	Above feedback high	The feedback is above the limit set in par. 4-57 <i>Warning Feedback High</i> .
[21]	Thermal warning	The thermal warning turns on when the temperature exceeds the limit in the motor, the frequency converter, the brake resistor, or the thermistor.
[25]	Reverse	<i>Reversing. Logic '1' = relay activated, 24 V DC when CW rotation of the motor. Logic '0' = relay not activated, no signal, when CCW rotation of the motor.</i>
[26]	Bus OK	Active communication (no time-out) via the serial communication port.
[27]	Torque limit and stop	Use in performing a coasting stop and in torque limit condition. If the frequency converter has received a stop signal and is at the torque limit, the signal is Logic '0'.
[28]	Brake, no warning	The brake is active and there are no warnings.
[29]	Brake ready, no fault	The brake is ready for operation and there are no faults.

[30]	Brake fault (IGBT)	The output is Logic '1' when the brake IGBT is short-circuited. Use this function to protect the frequency converter if there is a fault on the brake modules. Use the output/relay to cut out the main voltage from the frequency converter.
[35]	External Interlock	External Interlock function has been activated via one of the digital inputs.
[40]	Out of ref range	
[41]	Below reference low	
[42]	Above reference high	
[45]	Bus Ctrl	
[46]	Bus Ctrl 1 if timeout	
[47]	Bus Ctrl 0 if timeout	
[55]	Pulse output	
[60]	Comparator 0	See par. group 13-1*. If Comparator 0 is evaluated as TRUE, the output will go high. Otherwise, it will be low.
[61]	Comparator 1	See par. group 13-1*. If Comparator 2 is evaluated as TRUE, the output will go high. Otherwise, it will be low.
[62]	Comparator 2	See par. group 13-1*. If Comparator 2 is evaluated as TRUE, the output will go high. Otherwise, it will be low.
[63]	Comparator 3	See par. group 13-1*. If Comparator 3 is evaluated as TRUE, the output will go high. Otherwise, it will be low.
[64]	Comparator 4	See par. group 13-1*. If Comparator 4 is evaluated as TRUE, the output will go high. Otherwise, it will be low.
[65]	Comparator 5	See par. group 13-1*. If Comparator 5 is evaluated as TRUE, the output will go high. Otherwise, it will be low.
[70]	Logic Rule 0	See par. group 13-4*. If Logic Rule 0 is evaluated as TRUE, the output will go high. Otherwise, it will be low.
[71]	Logic Rule 1	See par. group 13-4*. If Logic Rule 1 is evaluated as TRUE, the output will go high. Otherwise, it will be low.
[72]	Logic Rule 2	See par. group 13-4*. If Logic Rule 2 is evaluated as TRUE, the output will go high. Otherwise, it will be low.
[73]	Logic Rule 3	See par. group 13-4*. If Logic Rule 3 is evaluated as TRUE, the output will go high. Otherwise, it will be low.
[74]	Logic Rule 4	See par. group 13-4*. If Logic Rule 4 is evaluated as TRUE, the output will go high. Otherwise, it will be low.
[75]	Logic Rule 5	See par. group 13-4*. If Logic Rule 5 is evaluated as TRUE, the output will go high. Otherwise, it will be low.
[80]	SL Digital Output A	See par. 13-52 <i>SL Controller Action</i> . The input will go high whenever the Smart Logic Action [38] <i>Set dig. out. A high</i> is executed. The input will go low whenever the Smart Logic Action [32] <i>Set dig. out. A low</i> is executed.
[81]	SL Digital Output B	See par. 13-52 <i>SL Controller Action</i> . The input will go high whenever the Smart Logic Action [39] <i>Set dig. out. B high</i> is executed. The input will go low whenever the Smart Logic Action [33] <i>Set dig. out. B low</i> is executed.
[82]	SL Digital Output C	See par. 13-52 <i>SL Controller Action</i> . The input will go high whenever the Smart Logic Action [40] <i>Set dig. out. C high</i> is executed. The input will go low whenever the Smart Logic Action [34] <i>Set dig. out. C low</i> is executed.
[83]	SL Digital Output D	See par. 13-52 <i>SL Controller Action</i> . The input will go high whenever the Smart Logic Action [41] <i>Set dig. out. D high</i> is executed. The input will go low whenever the Smart Logic Action [35] <i>Set dig. out. D low</i> is executed.
[84]	SL Digital Output E	See par. 13-52 <i>SL Controller Action</i> . The input will go high whenever the Smart Logic Action [42] <i>Set dig. out. E high</i> is executed. The input will go low whenever the Smart Logic Action [36] <i>Set dig. out. E low</i> is executed.

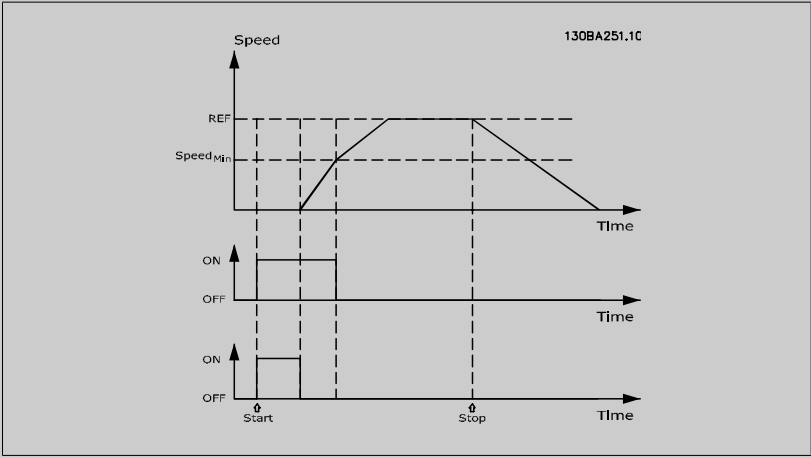
[85]	SL Digital Output F	See par. 13-52 <i>SL Controller Action</i> . The input will go high whenever the Smart Logic Action [43] <i>Set dig. out. F high</i> is executed. The input will go low whenever the Smart Logic Action [37] <i>Set dig. out. F low</i> is executed.
[160]	No alarm	The output is high when no alarm is present.
[161]	Running reverse	The output is high when the frequency converter is running counter clockwise (the logical product of the status bits 'running' AND 'reverse').
[165]	Local reference active	The output is high when par. 3-13 <i>Reference Site</i> = [2] Local or when par. 3-13 <i>Reference Site</i> = [0] <i>Linked to hand auto</i> at the same time as the LCP is in Hand on mode.
[166]	Remote reference active	The output is high when par. 3-13 <i>Reference Site</i> [1] or <i>Linked to hand/auto</i> [0] while the LCP is in [Auto on] mode.
[167]	Start command active	The output is high when there is an active Start command (i.e. via digital input bus connection or [Hand on] or [Auto on]), and no Stop or Start command is active.
[168]	Drive in hand mode	The output is high when the frequency converter is in Hand on mode (as indicated by the LED light above [Hand on]).
[169]	Drive in auto mode	The output is high when the frequency converter is in Hand on mode (as indicated by the LED light above [Auto on]).
[180]	Clock Fault	The clock function has been reset to default (2000-01-01) because of a power failure.
[181]	Preventive Maintenance	One or more of the Preventive Maintenance Events programmed in par. 23-10 <i>Maintenance Item</i> has passed the time for the specified action in par. 23-11 <i>Maintenance Action</i> .
[190]	No-Flow	A No-Flow situation or Minimum Speed situation has been detected if enabled in par. 22-21 <i>Low Power Detection</i> and/or par. 22-22 <i>Low Speed Detection</i> .
[191]	Dry Pump	A Dry Pump condition has been detected. This function must be enabled in par. 22-26 <i>Dry Pump Function</i> .
[192]	End of Curve	A pump running with max. speed for a period of time without reaching the set pressure has been detected. To enable this function please see par. 22-50 <i>End of Curve Function</i> .
[193]	Sleep Mode	The frequency converter/system has turned into sleep mode. See par. 22-4*.
[194]	Broken Belt	A Broken Belt condition has been detected. This function must be enabled in par. 22-60 <i>Broken Belt Function</i> .
[195]	Bypass Valve Control	<p>The bypass valve control (Digital / Relay output in the frequency converter) is used for compressor systems to unload the compressor during start-up by using a bypass valve. After the start command is given the bypass valve will be open until the frequency converter reaches par. 4-11 <i>Motor Speed Low Limit [RPM]</i> . After the limit has been reached the bypass valve will be closed, allowing the compressor to operate normally. This procedure will not be activated again before a new start is initiated and the frequency converter speed is zero during the receiving of start signal. par. 1-71 <i>Start Delay</i> can be used in order to delay the motor start. The Bypass valve control principle:</p> 
[196]	Fire Mode	The frequency converter is operating in Fire Mode. See 24-0* <i>Fire Mode</i> .
[197]	Fire Mode was act.	The frequency converter has been operating in Fire Mode, but is now back in normal operation.

[198] Drive Bypass To be used as signal for activating an external electromechanical bypass switching the motor direct on line. See 24-1* *Drive Bypass*.

If enabling the Drive Bypass Function, the frequency converter is no longer Safety Certified (for using the Safe Stop in versions where included).

The below setting options are all related to the Cascade Controller.
 Wiring diagrams and settings for parameter, see group 25-** for more details.

[200]	Full Capacity	All pumps running and at full speed
[201]	Pump1 Running	One or more of the pumps controlled by the Cascade Controller are running. The function will also depend on the setting of in par. 25-06 <i>Number of Pumps</i> . If set to <i>No</i> [0] Pump 1 refers to the pump controlled by relay RELAY1 etc. If set to <i>Yes</i> [1] Pump 1 refers to the pump controlled by the frequency converter only (without any of the build in relays involved) and Pump 2 to the pump controlled by the relay RELAY1. See below table:
[202]	Pump2 Running	See [201]
[203]	Pump3 Running	See [201]

Setting in Par. 5-3*	Setting in par. 25-06 <i>Number of Pumps</i>	
	[0] No	[1] Yes
[200] Pump 1 Running	Controlled by RELAY1	Frequency Converter controlled
[201] Pump 2 Running	Controlled by RELAY2	Controlled by RELAY1
[203] Pump 3 Running	Controlled by RELAY3	Controlled by RELAY2

5-30 Terminal 27 Digital Output

Option:

Function:

[0] *	No operation	Same options and functions as par. 5-3*.
[1]	Control ready	
[2]	Drive ready	
[3]	Drive rdy/rem ctrl	
[4]	Standby / no warning	
[5]	Running	
[6]	Running / no warning	
[8]	Run on ref/no warn	
[9]	Alarm	
[10]	Alarm or warning	
[11]	At torque limit	
[12]	Out of current range	
[13]	Below current, low	
[14]	Above current, high	
[15]	Out of speed range	
[16]	Below speed, low	
[17]	Above speed, high	
[18]	Out of feedb. range	
[19]	Below feedback, low	
[20]	Above feedback, high	
[21]	Thermal warning	
[25]	Reverse	
[26]	Bus OK	

[27]	Torque limit & stop
[28]	Brake, no brake war
[29]	Brake ready, no fault
[30]	Brake fault (IGBT)
[35]	External Interlock
[40]	Out of ref range
[41]	Below reference, low
[42]	Above ref, high
[45]	Bus ctrl.
[46]	Bus ctrl, 1 if timeout
[47]	Bus ctrl, 0 if timeout
[55]	Pulse output
[60]	Comparator 0
[61]	Comparator 1
[62]	Comparator 2
[63]	Comparator 3
[64]	Comparator 4
[65]	Comparator 5
[70]	Logic rule 0
[71]	Logic rule 1
[72]	Logic rule 2
[73]	Logic rule 3
[74]	Logic rule 4
[75]	Logic rule 5
[80]	SL digital output A
[81]	SL digital output B
[82]	SL digital output C
[83]	SL digital output D
[84]	SL digital output E
[85]	SL digital output F
[160]	No alarm
[161]	Running reverse
[165]	Local ref active
[166]	Remote ref active
[167]	Start command act.
[168]	Hand mode
[169]	Auto mode
[180]	Clock Fault
[181]	Prev. Maintenance
[190]	No-Flow
[191]	Dry Pump
[192]	End Of Curve
[193]	Sleep Mode
[194]	Broken Belt
[195]	Bypass Valve Control
[196]	Fire Mode
[197]	Fire Mode was Act.

[198]	Drive Bypass
[200]	Full capacity
[201]	Pump 1 running
[202]	Pump 2 running
[203]	Pump 3 running

5-31 Terminal 29 Digital Output

Option:	Function:
[0] *	No operation Same options and functions as par. 5-3*, Digital Outputs.
[1]	Control ready
[2]	Drive ready
[3]	Drive rdy/rem ctrl
[4]	Standby / no warning
[5]	Running
[6]	Running / no warning
[8]	Run on ref/no warn
[9]	Alarm
[10]	Alarm or warning
[11]	At torque limit
[12]	Out of current range
[13]	Below current, low
[14]	Above current, high
[15]	Out of speed range
[16]	Below speed, low
[17]	Above speed, high
[18]	Out of feedb. range
[19]	Below feedback, low
[20]	Above feedback, high
[21]	Thermal warning
[25]	Reverse
[26]	Bus OK
[27]	Torque limit & stop
[28]	Brake, no brake war
[29]	Brake ready, no fault
[30]	Brake fault (IGBT)
[35]	External Interlock
[40]	Out of ref range
[41]	Below reference, low
[42]	Above ref, high
[45]	Bus ctrl.
[46]	Bus ctrl, 1 if timeout
[47]	Bus ctrl, 0 if timeout
[55]	Pulse output
[60]	Comparator 0
[61]	Comparator 1
[62]	Comparator 2
[63]	Comparator 3

[64]	Comparator 4
[65]	Comparator 5
[70]	Logic rule 0
[71]	Logic rule 1
[72]	Logic rule 2
[73]	Logic rule 3
[74]	Logic rule 4
[75]	Logic rule 5
[80]	SL digital output A
[81]	SL digital output B
[82]	SL digital output C
[83]	SL digital output D
[84]	SL digital output E
[85]	SL digital output F
[160]	No alarm
[161]	Running reverse
[165]	Local ref active
[166]	Remote ref active
[167]	Start command act.
[168]	Hand mode
[169]	Auto mode
[180]	Clock Fault
[181]	Prev. Maintenance
[190]	No-Flow
[191]	Dry Pump
[192]	End Of Curve
[193]	Sleep Mode
[194]	Broken Belt
[195]	Bypass Valve Control
[196]	Fire Mode
[197]	Fire Mode was Act.
[198]	Drive Bypass
[200]	Full capacity
[201]	Pump 1 running
[202]	Pump 2 running
[203]	Pump 3 running

5-32 Term X30/6 Digi Out (MCB 101)

Option:
Function:

[0] *	No operation	This parameter is active when option module MCB 101 is mounted in the frequency converter.
[1]	Control ready	
[2]	Drive ready	
[3]	Drive rdy/rem ctrl	
[4]	Standby / no warning	
[5]	Running	
[6]	Running / no warning	
[8]	Run on ref/no warn	

[9]	Alarm
[10]	Alarm or warning
[11]	At torque limit
[12]	Out of current range
[13]	Below current, low
[14]	Above current, high
[15]	Out of speed range
[16]	Below speed, low
[17]	Above speed, high
[18]	Out of feedb. range
[19]	Below feedback, low
[20]	Above feedback, high
[21]	Thermal warning
[25]	Reverse
[26]	Bus OK
[27]	Torque limit & stop
[28]	Brake, no brake war
[29]	Brake ready, no fault
[30]	Brake fault (IGBT)
[35]	External Interlock
[40]	Out of ref range
[41]	Below reference, low
[42]	Above ref, high
[45]	Bus ctrl.
[46]	Bus ctrl, 1 if timeout
[47]	Bus ctrl, 0 if timeout
[55]	Pulse output
[60]	Comparator 0
[61]	Comparator 1
[62]	Comparator 2
[63]	Comparator 3
[64]	Comparator 4
[65]	Comparator 5
[70]	Logic rule 0
[71]	Logic rule 1
[72]	Logic rule 2
[73]	Logic rule 3
[74]	Logic rule 4
[75]	Logic rule 5
[80]	SL digital output A
[81]	SL digital output B
[82]	SL digital output C
[83]	SL digital output D
[84]	SL digital output E
[85]	SL digital output F
[160]	No alarm
[161]	Running reverse

[165]	Local ref active
[166]	Remote ref active
[167]	Start command act.
[168]	Hand mode
[169]	Auto mode
[180]	Clock Fault
[181]	Prev. Maintenance
[190]	No-Flow
[191]	Dry Pump
[192]	End Of Curve
[193]	Sleep Mode
[194]	Broken Belt
[195]	Bypass Valve Control
[196]	Fire Mode
[197]	Fire Mode was Act.
[198]	Drive Bypass
[200]	Full capacity
[201]	Pump 1 running
[202]	Pump 2 running
[203]	Pump 3 running

5-33 Term X30/7 Digi Out (MCB 101)

Option:	Function:
[0] *	No operation This parameter is active when option module MCB 101 is mounted in the frequency converter.
[1]	Control ready
[2]	Drive ready
[3]	Drive rdy/rem ctrl
[4]	Standby / no warning
[5]	Running
[6]	Running / no warning
[8]	Run on ref/no warn
[9]	Alarm
[10]	Alarm or warning
[11]	At torque limit
[12]	Out of current range
[13]	Below current, low
[14]	Above current, high
[15]	Out of speed range
[16]	Below speed, low
[17]	Above speed, high
[18]	Out of feedb. range
[19]	Below feedback, low
[20]	Above feedback, high
[21]	Thermal warning
[25]	Reverse
[26]	Bus OK
[27]	Torque limit & stop

[28]	Brake, no brake war
[29]	Brake ready, no fault
[30]	Brake fault (IGBT)
[35]	External Interlock
[40]	Out of ref range
[41]	Below reference, low
[42]	Above ref, high
[45]	Bus ctrl.
[46]	Bus ctrl, 1 if timeout
[47]	Bus ctrl, 0 if timeout
[60]	Comparator 0
[61]	Comparator 1
[62]	Comparator 2
[63]	Comparator 3
[64]	Comparator 4
[65]	Comparator 5
[70]	Logic rule 0
[71]	Logic rule 1
[72]	Logic rule 2
[73]	Logic rule 3
[74]	Logic rule 4
[75]	Logic rule 5
[80]	SL digital output A
[81]	SL digital output B
[82]	SL digital output C
[83]	SL digital output D
[84]	SL digital output E
[85]	SL digital output F
[160]	No alarm
[161]	Running reverse
[165]	Local ref active
[166]	Remote ref active
[167]	Start command act.
[168]	Hand mode
[169]	Auto mode
[180]	Clock Fault
[181]	Prev. Maintenance
[190]	No-Flow
[191]	Dry Pump
[192]	End Of Curve
[193]	Sleep Mode
[194]	Broken Belt
[195]	Bypass Valve Control
[200]	Full capacity
[201]	Pump 1 running
[202]	Pump 2 running
[203]	Pump 3 running

3.7.6 5-4* Relays

Parameters for configuring the timing and the output functions for the relays.

5-40 Function Relay

Array [8]

(Relay 1 [0], Relay 2 [1])

Option MCB 105: Relay 7 [6], Relay 8 [7] and Relay 9 [8])

Option:

Function:

Option	Function
[0] * No operation	Select options to define the function of the relays. The selection of each mechanical relay is realised in an array parameter.
[1] Control ready	
[2] Drive ready	
[3] Drive rdy/rem ctrl	
[4] Standby / no warning	
[5] Running	
[6] Running / no warning	
[8] Run on ref/no warn	
[9] Alarm	
[10] Alarm or warning	
[11] At torque limit	
[12] Out of current range	
[13] Below current, low	
[14] Above current, high	
[15] Out of speed range	
[16] Below speed, low	
[17] Above speed, high	
[18] Out of feedb. range	
[19] Below feedback, low	
[20] Above feedback, high	
[21] Thermal warning	
[25] Reverse	
[26] Bus OK	
[27] Torque limit & stop	
[28] Brake, no brake war	
[29] Brake ready, no fault	
[30] Brake fault (IGBT)	
[35] External Interlock	
[36] Control word bit 11	
[37] Control word bit 12	
[40] Out of ref range	
[41] Below reference, low	
[42] Above ref, high	
[45] Bus ctrl.	
[46] Bus ctrl, 1 if timeout	
[47] Bus ctrl, 0 if timeout	
[60] Comparator 0	

[61] Comparator 1

[62] Comparator 2

[63] Comparator 3

[64] Comparator 4

[65] Comparator 5

[70] Logic rule 0

[71] Logic rule 1

[72] Logic rule 2

[73] Logic rule 3

[74] Logic rule 4

[75] Logic rule 5

[80] SL digital output A

[81] SL digital output B

[82] SL digital output C

[83] SL digital output D

[84] SL digital output E

[85] SL digital output F

[160] No alarm

[161] Running reverse

[165] Local ref active

[166] Remote ref active

[167] Start command act.

[168] Hand mode

[169] Auto mode

[180] Clock Fault

[181] Prev. Maintenance

[190] No-Flow

[191] Dry Pump

[192] End Of Curve

[193] Sleep Mode

[194] Broken Belt

[195] Bypass Valve Control

[196] Fire Mode

[197] Fire Mode was Act.

[198] Drive Bypass

[211] Cascade Pump 1

[212] Cascade Pump 2

[213] Cascade Pump 3

5-41 On Delay, Relay

Array [8](Relay 1 [0], Relay 2 [1], Relay 3 [2], Relay 4 [3], Relay 5 [4], Relay 6 [5], Relay 7 [6], Relay 8 [7], Relay 9 [8])

Range:

0.01 s* [0.01 - 600.00 s]

Function:

Enter the delay of the relay cut-in time. Select one of available mechanical relays and MCO 105 in an array function. See par. 5-40 *Function Relay*. Relay 3-6 are included in MCB 112 (ATEX).

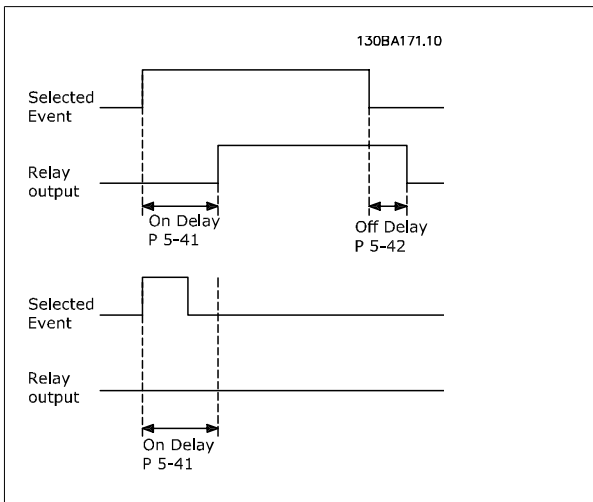

5-42 Off Delay, Relay

Array [8] (Relay 1 [0], Relay 2 [1], Relay 3 [2], Relay 4 [3], Relay 5 [4], Relay 6 [5], Relay 7 [6], Relay 8 [7], Relay 9 [8])

Range:	Function:
0.01 s* [0.01 - 600.00 s]	Enter the delay of the relay cut-out time. Select one of available mechanical relays and MCO 105 in an array function. See par. 5-40 <i>Function Relay</i> .

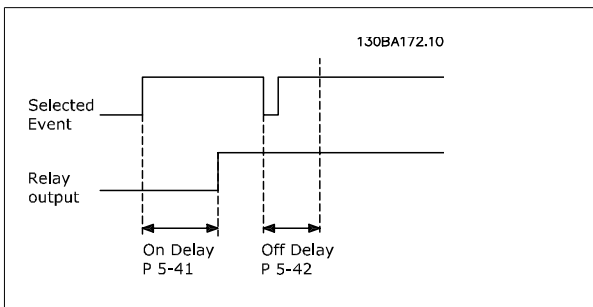

If the selected Event condition changes before the on- or off delay timer expires, the relay output is unaffected.

3.7.7 5-5* Pulse Input

The pulse input parameters are used to define an appropriate window for the impulse reference area by configuring the scaling and filter settings for the pulse inputs. Input terminals 29 or 33 act as frequency reference inputs. Set terminal 29 (par. 5-13 *Terminal 29 Digital Input*) or terminal 33 (par. 5-15 *Terminal 33 Digital Input*) to *Pulse input* [32]. If terminal 29 is used as an input, then set par. 5-02 *Terminal 29 Mode* to *Input* [0].

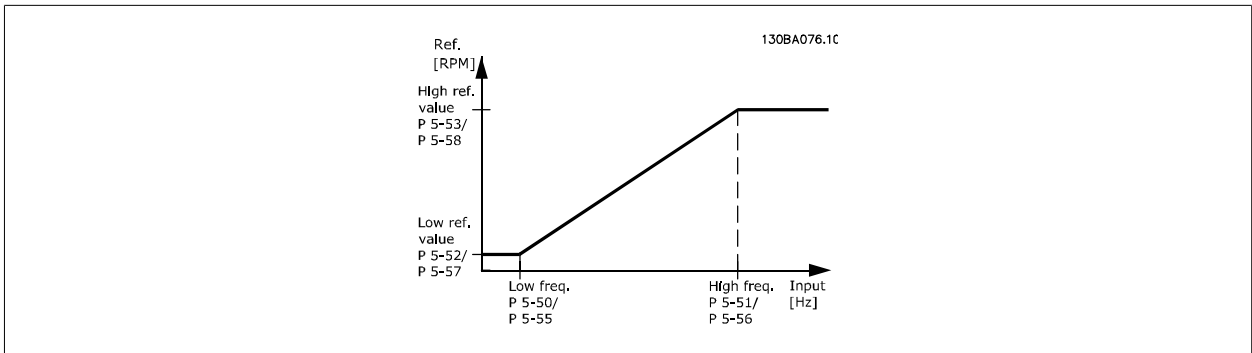

5-50 Term. 29 Low Frequency**Range:**

100 Hz* [0 - 110000 Hz]

Function:

Enter the low frequency limit corresponding to the low motor shaft speed (i.e. low reference value) in par. 5-52 *Term. 29 Low Ref./Feedb. Value*. Refer to the diagram in this section.

5-51 Term. 29 High Frequency**Range:**

100 Hz* [0 - 110000 Hz]

Function:

Enter the high frequency limit corresponding to the high motor shaft speed (i.e. high reference value) in par. 5-53 *Term. 29 High Ref./Feedb. Value*.

5-52 Term. 29 Low Ref./Feedb. Value**Range:**

0.000 N/A* [-999999.999 - 999999.999 N/A]

Function:

Enter the low reference value limit for the motor shaft speed [RPM]. This is also the lowest feedback value, see also par. 5-57 *Term. 33 Low Ref./Feedb. Value*.

5-53 Term. 29 High Ref./Feedb. Value**Range:**

100.000 N/A* [-999999.999 - 999999.999 N/A]

Function:

Enter the high reference value [RPM] for the motor shaft speed and the high feedback value, see also par. 5-58 *Term. 33 High Ref./Feedb. Value*.

5-54 Pulse Filter Time Constant #29**Range:**

100 ms* [1 - 1000 ms]

Function:

Enter the pulse filter time constant. The pulse filter dampens oscillations of the feedback signal, which is an advantage if there is a lot of noise in the system. A high time constant value results in better dampening but also increases the time delay through the filter. This parameter cannot be adjusted while the motor is running.

5-55 Term. 33 Low Frequency**Range:**

100 Hz* [0 - 110000 Hz]

Function:

Enter the low frequency corresponding to the low motor shaft speed (i.e. low reference value) in par. 5-57 *Term. 33 Low Ref./Feedb. Value*.

5-56 Term. 33 High Frequency**Range:**

100 Hz* [0 - 110000 Hz]

Function:

Enter the high frequency corresponding to the high motor shaft speed (i.e. high reference value) in par. 5-58 *Term. 33 High Ref./Feedb. Value*.

5-57 Term. 33 Low Ref./Feedb. Value**Range:**

0.000 N/A* [-999999.999 - 999999.999 N/A]

Function:

Enter the low reference value [RPM] for the motor shaft speed. This is also the low feedback value, see also par. 5-52 *Term. 29 Low Ref./Feedb. Value*.

5-58 Term. 33 High Ref./Feedb. Value**Range:**

100.000 N/A* [-999999.999 - 999999.999 N/A]

Function:

Enter the high reference value [RPM] for the motor shaft speed. See also par. 5-53 *Term. 29 High Ref./Feedb. Value*.

5-59 Pulse Filter Time Constant #33**Range:**

100 ms* [1 - 1000 ms]

Function:

Enter the pulse filter time constant. The low-pass filter reduces the influence on and dampens oscillations on the feedback signal from the control. This is an advantage, e.g. if there is a great amount on noise in the system. This parameter cannot be adjusted while the motor is running.

3.7.8 5-6* Pulse Outputs

Parameters for configuring the scaling and output functions of pulse outputs. The pulse outputs are designated to terminals 27 or 29. Select terminal 27 output in par. 5-01 *Terminal 27 Mode* and terminal 29 output in par. 5-02 *Terminal 29 Mode*.

3

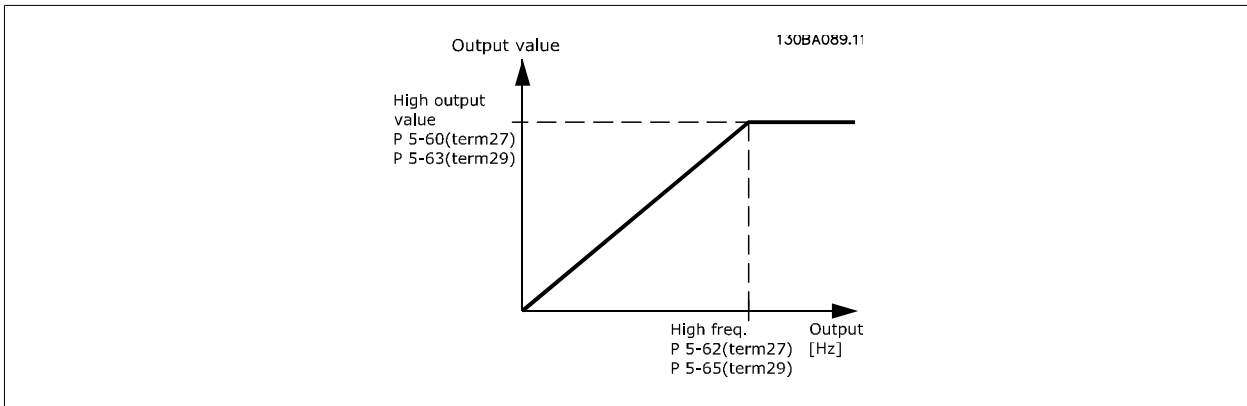

Options for readout output variables:

[0]	No operation
[45]	Bus ctrl.
[48]	Bus ctrl., timeout
[100]	Output frequency
[101]	Reference
[102]	Feedback
[103]	Motor current
[104]	Torque relative to limit
[105]	Torque relative to rated
[106]	Power
[107]	Speed
[108]	Torque
[109]	Max Out Freq
[113]	Ext. Closed Loop
[114]	Ext. Closed Loop
[115]	Ext. Closed Loop

5-60 Terminal 27 Pulse Output Variable

Option:

Function:

[0] * No operation

Same options and functions as par. 5-6*.
 Select the operation variable assigned for terminal 27 readouts.
 This parameter cannot be adjusted while the motor is running.

[45] Bus ctrl.

[48] Bus ctrl., timeout

[100] Output freq. 0-100

[101] Reference Min-Max

[102] Feedback +-200%

[103] Motor cur. 0-Imax

[104] Torque 0-Tlim

[105] Torque 0-Tnom

[106] Power 0-Pnom

[107] Speed 0-HighLim

[113] Ext. Closed Loop 1

[114] Ext. Closed Loop 2

[115] Ext. Closed Loop 3

5-62 Pulse Output Max Freq #27

Range:

Function:

5000 Hz* [0 - 32000 Hz]

Set the maximum frequency for terminal 27, corresponding to the output variable selected in par. 5-60 *Terminal 27 Pulse Output Variable*.
 This parameter cannot be adjusted while the motor is running.

5-63 Terminal 29 Pulse Output Variable

Option:

Function:

[0] * No operation

Select the variable for viewing on the terminal 29 display.
 This parameter cannot be adjusted while the motor is running.

[45] Bus ctrl.

[48] Bus ctrl., timeout

[100] Output freq. 0-100

[101] Reference Min-Max

[102] Feedback +-200%

[103] Motor cur. 0-Imax

[104] Torque 0-Tlim

[105] Torque 0-Tnom

[106] Power 0-Pnom

[107] Speed 0-HighLim

[113] Ext. Closed Loop 1

[114] Ext. Closed Loop 2

[115] Ext. Closed Loop 3

5-65 Pulse Output Max Freq #29

Range:

Function:

5000 Hz* [0 - 32000 Hz]

Set the maximum frequency for terminal 29 corresponding to the output variable set in par. 5-63 *Terminal 29 Pulse Output Variable*.
 This parameter cannot be adjusted while the motor is running.

5-66 Terminal X30/6 Pulse Output Variable

Option:	Function:
[0] * No operation	Select the variable for read-out on terminal X30/6. This parameter cannot be adjusted while the motor is running. This parameter is active when option module MCB 101 is installed in the frequency converter.
[45] Bus ctrl.	
[48] Bus ctrl., timeout	
[100] Output freq. 0-100	
[101] Reference Min-Max	
[102] Feedback +-200%	
[103] Motor cur. 0-Imax	
[104] Torque 0-Tlim	
[105] Torque 0-Tnom	
[106] Power 0-Pnom	
[107] Speed 0-HighLim	
[113] Ext. Closed Loop 1	
[114] Ext. Closed Loop 2	
[115] Ext. Closed Loop 3	

5-68 Pulse Output Max Freq #X30/6

Range:	Function:
5000 Hz* [0 - 32000 Hz]	Select the maximum frequency on terminal X30/6 referring to the output variable in par. 5-66 <i>Terminal X30/6 Pulse Output Variable</i> . This parameter cannot be adjusted while the motor is running. This parameter is active when option module MCB 101 is mounted in the frequency converter.

3.7.9 5-9*Bus Controlled

This parameter group selects digital and relay outputs via a fieldbus setting.

5-90 Digital & Relay Bus Control

Range:	Function:
0 N/A* [0 - 2147483647 N/A]	This parameter holds the state of the digital outputs and relays that is controlled by bus. A logical '1' indicates that the output is high or active. A logical '0' indicates that the output is low or inactive.

Bit 0	CC Digital Output Terminal 27
Bit 1	CC Digital Output Terminal 29
Bit 2	GPIO Digital Output Terminal X 30/6
Bit 3	GPIO Digital Output Terminal X 30/7
Bit 4	CC Relay 1 output terminal
Bit 5	CC Relay 2 output terminal
Bit 6	Option B Relay 1 output terminal
Bit 7	Option B Relay 2 output terminal
Bit 8	Option B Relay 3 output terminal
Bit 9-15	Reserved for future terminals
Bit 16	Option C Relay 1 output terminal
Bit 17	Option C Relay 2 output terminal
Bit 18	Option C Relay 3 output terminal
Bit 19	Option C Relay 4 output terminal
Bit 20	Option C Relay 5 output terminal
Bit 21	Option C Relay 6 output terminal
Bit 22	Option C Relay 7 output terminal
Bit 23	Option C Relay 8 output terminal
Bit 24-31	Reserved for future terminals

5-93 Pulse Out #27 Bus Control

Range:

0.00 %* [0.00 - 100.00 %]

Function:

Contains the frequency to apply to the digital output terminal 27, when it is configured as [Bus Controlled].

5-94 Pulse Out #27 Timeout Preset

Range:

0.00 %* [0.00 - 100.00 %]

Function:

Contains the frequency to apply to the digital output terminal 27, when it is configured as [Bus Controlled Timeout] and timeout is detected.

5-95 Pulse Out #29 Bus Control

Range:

0.00 %* [0.00 - 100.00 %]

Function:

Contains the frequency to apply to the digital output terminal 29, when it is configured as [Bus Controlled].

5-96 Pulse Out #29 Timeout Preset

Range:

0.00 %* [0.00 - 100.00 %]

Function:

Contains the frequency to apply to the digital output terminal 29, when it is configured as [Bus Controlled Timeout] and timeout is detected.

5-97 Pulse Out #X30/6 Bus Control

Range:

0.00 %* [0.00 - 100.00 %]

Function:

Contains the frequency to apply to the digital output terminal 27, when it is configured as [Bus Controlled].

5-98 Pulse Out #X30/6 Timeout Preset

Range:

0.00 %* [0.00 - 100.00 %]

Function:

Contains the frequency to apply to the digital output terminal 6, when it is configured as [Bus Controlled Timeout] and timeout is detected.

3.8 Main Menu - Analog In/Out - Group 6

3.8.1 6-** Analog In/Out

Parameter group for configuration of the analog input and output.

3.8.2 6-0* Analog I/O Mode

Parameter group for setting up the analog I/O configuration.

The frequency converter is equipped with 2 analog inputs: Terminal 53 and 54. The analog inputs can freely be allocated to either voltage (0 - 10 V) or current input (0/4 - 20 mA)

**NB!**

Thermistors may be connected to either an analog or a digital input.

6-00 Live Zero Timeout Time

Range:

10 s* [1 - 99 s]

Function:

Enter the Live Zero Time-out time period. Live Zero Time-out Time is active for analog inputs, i.e. terminal 53 or terminal 54, used as reference or feedback sources. If the reference signal value associated with the selected current input falls below 50% of the value set in par. 6-10 *Terminal 53 Low Voltage*, par. 6-12 *Terminal 53 Low Current*, par. 6-20 *Terminal 54 Low Voltage* or par. 6-22 *Terminal 54 Low Current* for a time period longer than the time set in par. 6-00 *Live Zero Timeout Time*, the function selected in par. 6-01 *Live Zero Timeout Function* will be activated.

6-01 Live Zero Timeout Function

Option:
Function:

Select the time-out function. The function set in par. 6-01 *Live Zero Timeout Function* will be activated if the input signal on terminal 53 or 54 is below 50% of the value in par. 6-10 *Terminal 53 Low Voltage*, par. 6-12 *Terminal 53 Low Current*, par. 6-20 *Terminal 54 Low Voltage* or par. 6-22 *Terminal 54 Low Current* for a time period defined in par. 6-00 *Live Zero Timeout Time*. If several time-outs occur simultaneously, the frequency converter prioritises the time-out functions as follows:

1. par. 6-01 *Live Zero Timeout Function*
2. par. 8-04 *Control Timeout Function*

The output frequency of the frequency converter can be:

- [1] frozen at the present value
- [2] overruled to stop
- [3] overruled to jog speed
- [4] overruled to max. speed
- [5] overruled to stop with subsequent trip

[0] * Off

[1] Freeze output

[2] Stop

[3] Jogging

[4] Max. speed

[5] Stop and trip

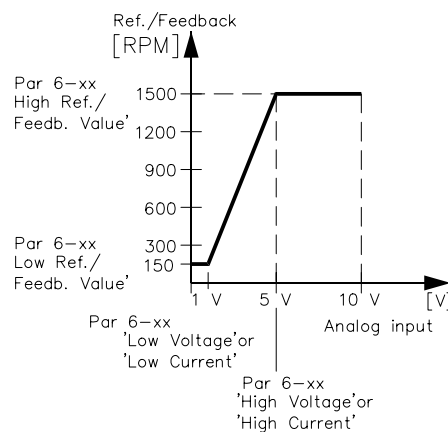

6-02 Fire Mode Live Zero Timeout Function

Option:
Function:

The function set in par. 6-01 *Live Zero Timeout Function* will be activated if the input signal on analogue inputs is below 50% of the value defined in parameter group 6.1 to 6.6 "Terminal xx Low Current" or "Terminal xx Low Voltage" for a time period defined in par. 6-00 *Live Zero Timeout Time*.

[0] *	Off
[1]	Freeze output
[2]	Stop
[3]	Jogging
[4]	Max. speed

3

3.8.3 6-1* Analog Input 1

Parameters for configuring the scaling and limits for analog input 1 (terminal 53).

6-10 Terminal 53 Low Voltage

Range:

0.07 V* [0.00 - par. 6-11 V]

Function:

Enter the low voltage value. This analog input scaling value should correspond to the low reference/feedback value set in par. 6-14 *Terminal 53 Low Ref./Feedb. Value*.

6-11 Terminal 53 High Voltage

Range:

10.00 V* [par. 6-10 - 10.00 V]

Function:

Enter the high voltage value. This analog input scaling value should correspond to the high reference/feedback value set in par. 6-15 *Terminal 53 High Ref./Feedb. Value*.

6-12 Terminal 53 Low Current

Range:

4.00 mA* [0.00 - par. 6-13 mA]

Function:

Enter the low current value. This reference signal should correspond to the low reference/feedback value, set in par. 6-14 *Terminal 53 Low Ref./Feedb. Value*. The value must be set at >2 mA in order to activate the Live Zero Time-out Function in par. 6-01 *Live Zero Timeout Function*.

6-13 Terminal 53 High Current

Range:

20.00 mA* [par. 6-12 - 20.00 mA]

Function:

Enter the high current value corresponding to the high reference/feedback set in par. 6-15 *Terminal 53 High Ref./Feedb. Value*.

6-14 Terminal 53 Low Ref./Feedb. Value

Range:

0.000 N/A* [-999999.999 - 999999.999 N/A]

Function:

Enter the analog input scaling value that corresponds to the low voltage/low current set in par. 6-10 *Terminal 53 Low Voltage* and par. 6-12 *Terminal 53 Low Current*.

6-15 Terminal 53 High Ref./Feedb. Value

Range:

50.000 N/A* [-999999.999 - 999999.999 N/A]

Function:

Enter the analog input scaling value that corresponds to the high voltage/high current value set in par. 6-11 *Terminal 53 High Voltage* and par. 6-13 *Terminal 53 High Current*.

6-16 Terminal 53 Filter Time Constant**Range:**

0.001 s* [0.001 - 10.000 s]

Function:

Enter the time constant. This is a first-order digital low pass filter time constant for suppressing electrical noise in terminal 53. A high time constant value improves dampening but also increases the time delay through the filter.

This parameter cannot be adjusted while the motor is running.

6-17 Terminal 53 Live Zero**Option:**

[0] Disabled

[1]* Enabled

Function:

This parameter makes it possible to disable the Live Zero monitoring. E.g. to be used if the analog outputs are used as part of a de-central I/O system (e.g. when not as part of any frequency converter related control functions, but feeding a Building Management system with data).

3.8.4 6-2* Analog Input 2

Parameters for configuring the scaling and limits for analog input 2 (terminal 54).

6-20 Terminal 54 Low Voltage**Range:**

0.07 V* [0.00 - par. 6-21 V]

Function:

Enter the low voltage value. This analog input scaling value should correspond to the low reference/feedback value, set in par. 6-24 *Terminal 54 Low Ref./Feedb. Value*.

6-21 Terminal 54 High Voltage**Range:**

10.00 V* [par. 6-20 - 10.00 V]

Function:

Enter the high voltage value. This analog input scaling value should correspond to the high reference/feedback value set in par. 6-25 *Terminal 54 High Ref./Feedb. Value*.

6-22 Terminal 54 Low Current**Range:**

4.00 mA* [0.00 - par. 6-23 mA]

Function:

Enter the low current value. This reference signal should correspond to the low reference/feedback value, set in par. 6-24 *Terminal 54 Low Ref./Feedb. Value*. The value must be set at >2 mA in order to activate the Live Zero Time-out Function in par. 6-01 *Live Zero Timeout Function*.

6-23 Terminal 54 High Current**Range:**

20.00 mA* [par. 6-22 - 20.00 mA]

Function:

Enter the high current value corresponding to the high reference/feedback value set in par. 6-25 *Terminal 54 High Ref./Feedb. Value*.

6-24 Terminal 54 Low Ref./Feedb. Value**Range:**

0.000 N/A* [-999999.999 - 999999.999 N/A]

Function:

Enter the analog input scaling value that corresponds to the low voltage/low current value set in par. 6-20 *Terminal 54 Low Voltage* and par. 6-22 *Terminal 54 Low Current*.

6-25 Terminal 54 High Ref./Feedb. Value**Range:**

100.000 N/A* [-999999.999 - 999999.999 N/A]

Function:

Enter the analog input scaling value that corresponds to the high voltage/high current value set in par. 6-21 *Terminal 54 High Voltage* and par. 6-23 *Terminal 54 High Current*.

6-26 Terminal 54 Filter Time Constant

Range:

0.001 s* [0.001 - 10.000 s]

Function:

Enter the time constant. This is a first-order digital low pass filter time constant for suppressing electrical noise in terminal 54. A high time constant value improves dampening but also increases the time delay through the filter.

This parameter cannot be adjusted while the motor is running.

6-27 Terminal 54 Live Zero

Option:

[0] Disabled

[1] * Enabled

Function:

This parameter makes it possible to disable the Live Zero monitoring. E.g. to be used if the analog outputs are used as part of a de-central I/O system (e.g. when not as part of any frequency converter related control functions, but feeding a Building Management System with data).

3.8.5 6-3* Analog Input 3 (MCB 101)

Parameter group for configuring the scale and limits for analog input 3 (X30/11) placed on option module MCB 101.

6-30 Terminal X30/11 Low Voltage

Range:

0.07 V* [0.00 - par. 6-31 V]

Function:

Sets the analog input scaling value to correspond to the low reference/feedback value (set in par. 6-34 *Term. X30/11 Low Ref./Feedb. Value*).

6-31 Terminal X30/11 High Voltage

Range:

10.00 V* [par. 6-30 - 10.00 V]

Function:

Sets the analog input scaling value to correspond to the high reference/feedback value (set in par. 6-35 *Term. X30/11 High Ref./Feedb. Value*).

6-34 Term. X30/11 Low Ref./Feedb. Value

Range:

0.000 N/A* [-999999.999 - 999999.999 N/A]

Function:

Sets the analog input scaling value to correspond to the low voltage value (set in par. 6-30 *Terminal X30/11 Low Voltage*).

6-35 Term. X30/11 High Ref./Feedb. Value

Range:

100.000 N/A* [-999999.999 - 999999.999 N/A]

Function:

Sets the analog input scaling value to correspond to the high voltage value (set in par. 6-31 *Terminal X30/11 High Voltage*).

6-36 Term. X30/11 Filter Time Constant

Range:

0.001 s* [0.001 - 10.000 s]

Function:

A 1st order digital low pass filter time constant for suppressing electrical noise on terminal X30/11. par. 6-36 *Term. X30/11 Filter Time Constant* cannot be changed while the motor is running.

6-37 Term. X30/11 Live Zero

Option:

[0] Disabled

[1] * Enabled

Function:

This parameter makes it possible to disable the Live Zero monitoring. E.g. to be used if the analog outputs are used as part of a decentral I/O system (e.g. when not part of any frequency converter related control functions, but feeding a Building Management System with data)

3.8.6 6-4* Analog Input 4 (MCB 101)

Parameter group for configuring the scale and limits for analog input 4 (X30/12) placed on option module MCB 101.

6-40 Terminal X30/12 Low Voltage

Range:	Function:
0.07 V* [0.00 - par. 6-41 V]	Sets the analog input scaling value to correspond to the low reference/feedback value set in par. 6-44 <i>Term. X30/12 Low Ref./Feedb. Value.</i>

6-41 Terminal X30/12 High Voltage

Range:	Function:
10.00 V* [par. 6-40 - 10.00 V]	Sets the analog input scaling value to correspond to the high reference/feedback value set in par. 6-45 <i>Term. X30/12 High Ref./Feedb. Value.</i>

6-44 Term. X30/12 Low Ref./Feedb. Value

Range:	Function:
0.000 N/A* [-999999.999 - 999999.999 N/A]	Sets the analog output scaling value to correspond to the low voltage value set in par. 6-40 <i>Terminal X30/12 Low Voltage.</i>

6-45 Term. X30/12 High Ref./Feedb. Value

Range:	Function:
100.000 N/A* [-999999.999 - 999999.999 N/A]	Sets the analog input scaling value to correspond to the high voltage value set in par. 6-41 <i>Terminal X30/12 High Voltage.</i>

6-46 Term. X30/12 Filter Time Constant

Range:	Function:
0.001 s* [0.001 - 10.000 s]	A 1 st order digital low pass filter time constant for suppressing electrical noise on terminal X30/12. par. 6-46 <i>Term. X30/12 Filter Time Constant</i> cannot be changed while the motor is running.

6-47 Term. X30/12 Live Zero

Option:	Function:
	This parameter makes it possible to disable the Live Zero monitoring. E.g. to be used if the analog outputs are used as part of a decentral I/O system (e.g. when not part of any frequency converter related control functions, but feeding a Building Management System with data)
[0]	Disabled
[1]*	Enabled

3.8.7 6-5* Analog Output 1

Parameters for configuring the scaling and limits for analog output 1, i.e. Terminal 42. Analog outputs are current outputs: 0/4 – 20 mA. Common terminal (terminal 39) is the same terminal and has the same electrical potential for analog common and digital common connection. Resolution on analog output is 12 bit.

6-50 Terminal 42 Output

Option:	Function:
	Select the function of Terminal 42 as an analog current output. A motor current of 20 mA corresponds to I_{max} .
[0]*	No operation
[100]	Output freq. 0-100 : 0 - 100 Hz
[101]	Reference Min-Max : Minimum reference - Maximum reference

[102]	Feedback +-200%	: -200% to +200% of par. 20-14
[103]	Motor cur. 0-Imax	: 0 - Inverter Max. Current (par. 16-37)
[104]	Torque 0-Tlim	: 0 - Torque limit (par. 4-16)
[105]	Torque 0-Tnom	: 0 - Motor rated torque
[106]	Power 0-Pnom	: 0 - Motor rated power
[107]	Speed 0-HighLim	: 0 - Speed High Limit (par. 4-13 and par. 4-14)
[113]	Ext. Closed Loop 1	0 - 100%
[114]	Ext. Closed Loop 2	0 - 100%
[115]	Ext. Closed Loop 3	0 - 100%
[130]	Out frq 0-100 4-20mA	:0 - 100 Hz
[131]	Reference 4-20mA	Minimum Reference - Maximum Reference
[132]	Feedback 4-20mA	-200% to +200% of par. 20-14
[133]	Motor cur. 4-20mA	0 - Inverter Max. Current (par. 16-37 <i>Inv. Max. Current</i>)
[134]	Torq.0-lim 4-20 mA	:0 - Torque limit (par. 4-16)
[135]	Torq.0-nom 4-20mA	:0 - Motor rated torque
[136]	Power 4-20mA	0 - Motor rated power
[137]	Speed 4-20mA	0 - Speed High Limit (par. 4-13 and par. 4-14)
[139]	Bus ctrl.	0 - 100%
[140]	Bus ctrl. 4-20 mA	0 - 100%
[141]	Bus ctrl t.o.	0 - 100%
[142]	Bus ctrl t.o. 4-20mA	0 - 100%
[143]	Ext. CL 1 4-20mA	0 - 100%
[144]	Ext. CL 2 4-20mA	0 - 100%
[145]	Ext. CL 3 4-20mA	0 - 100%

NB!

Values for setting the Minimum Reference is found in open loop par. 3-02 *Minimum Reference* and for closed loop par. 20-13 *Minimum Reference/Feedb.* - values for maximum reference for open loop is found in par. 3-03 *Maximum Reference* and for closed loop par. 20-14 *Maximum Reference/Feedb.*

6-51 Terminal 42 Output Min Scale**Range:**

0.00 %* [0.00 - 200.00 %]

Function:

Scale for the minimum output (0 or 4 mA) of the analogue signal at terminal 42.
Set the value to be the **percentage** of the full range of the variable selected in par. 6-50 *Terminal 42 Output*.

3

6-52 Terminal 42 Output Max Scale

Range:

100.00 %* [0.00 - 200.00 %]

Function:

Scale for the maximum output (20 mA) of the analog signal at terminal 42.
Set the value to be the percentage of the full range of the variable selected in par. 6-50 *Terminal 42 Output*.

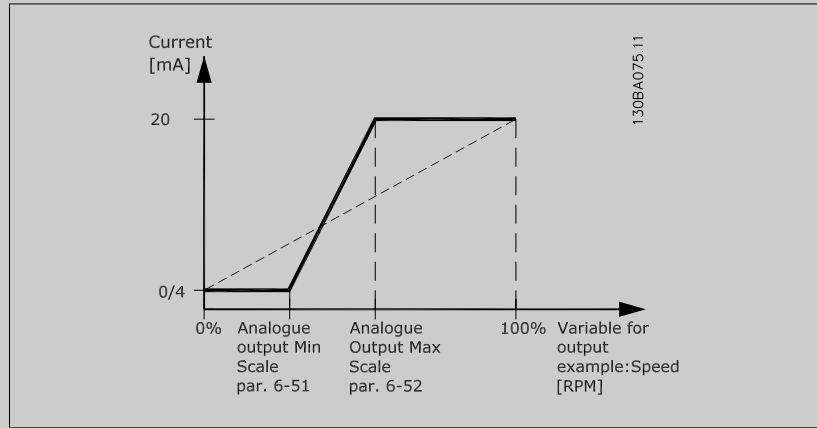

It is possible to get a value lower than 20 mA at full scale by programming values >100% by using a formula as follows:

$$20 \text{ mA} \mid \text{desired maximum current} \times 100 \%$$

$$\text{i.e. } 10 \text{ mA} : \frac{20 \text{ mA}}{10 \text{ mA}} \times 100 \% = 200 \%$$

EXAMPLE 1:

Variable value= OUTPUT FREQUENCY, range = 0-100 Hz

Range needed for output = 0-50 Hz

Output signal 0 or 4 mA is needed at 0 Hz (0% of range) - set par. 6-51 *Terminal 42 Output Min Scale* to 0%

Output signal 20 mA is needed at 50 Hz (50% of range) - set par. 6-52 *Terminal 42 Output Max Scale* to 50%

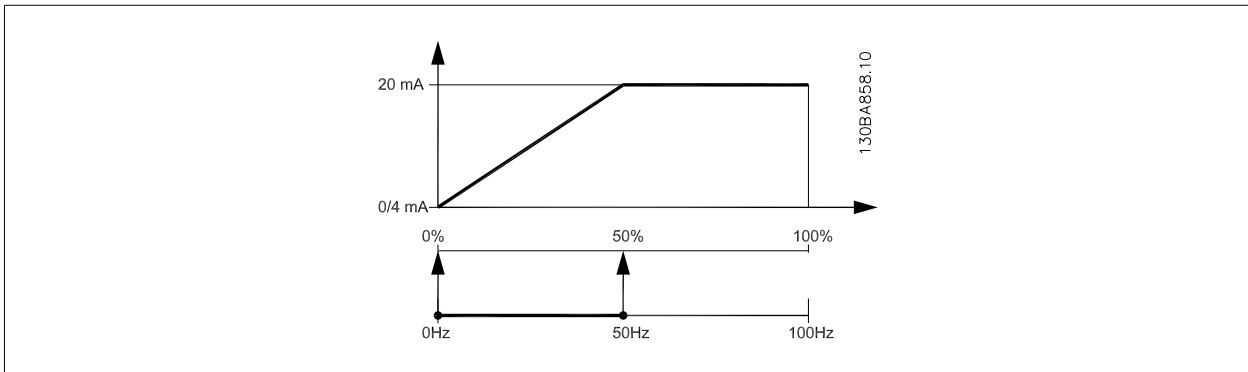

EXAMPLE 2:

Variable= FEEDBACK, range= -200% to +200%

Range needed for output= 0-100%

Output signal 0 or 4 mA is needed at 0% (50% of range) - set par. 6-51 *Terminal 42 Output Min Scale* to 50%

Output signal 20 mA is needed at 100% (75% of range) - set par. 6-52 *Terminal 42 Output Max Scale* to 75%

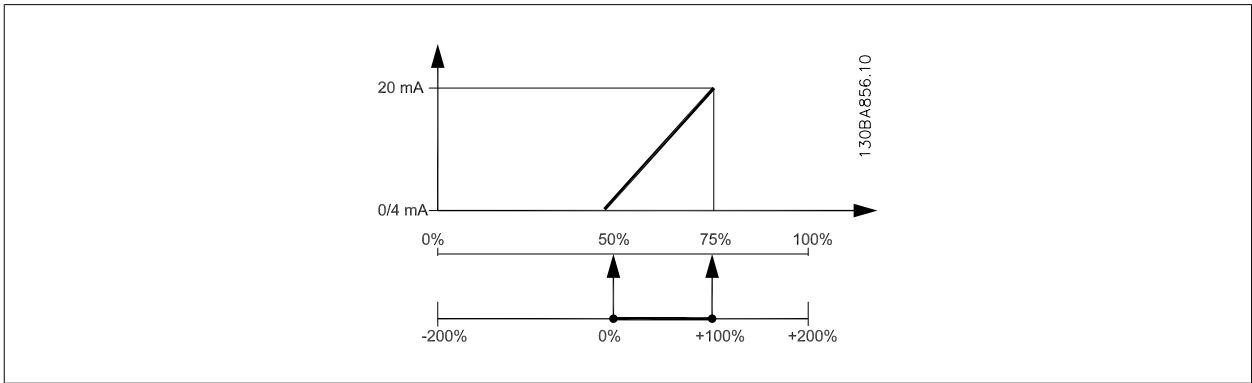

EXAMPLE 3:

Variable value= REFERENCE, range= Min ref - Max ref

Range needed for output= Min ref (0%) - Max ref (100%), 0-10 mA

Output signal 0 or 4 mA is needed at Min ref - set par. 6-51 *Terminal 42 Output Min Scale* to 0%

Output signal 10 mA is needed at Max ref (100% of range) - set par. 6-52 *Terminal 42 Output Max Scale* to 200% (20 mA / 10 mA x 100%=200%).

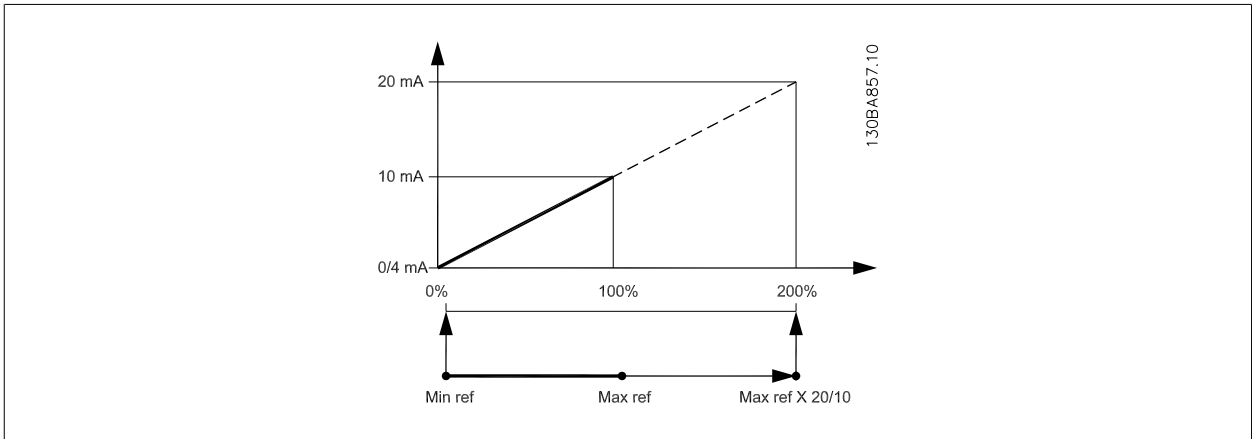

6-53 Terminal 42 Output Bus Control

Range:	Function:
0.00 %* [0.00 - 100.00 %]	Holds the level of Output 42 if controlled by bus.

6-54 Terminal 42 Output Timeout Preset

Range:	Function:
0.00 %* [0.00 - 100.00 %]	Holds the preset level of Output 42. In case of a bus timeout and a timeout function is selected in par. 6-50 <i>Terminal 42 Output</i> the output will preset to this level.

3.8.8 6-6* Analog Output 2 (MCB 101)

Analog outputs are current outputs: 0/4 - 20 mA. Common terminal (terminal X30/8) is the same terminal and electrical potential for analog common connection. Resolution on analog output is 12 bit.

6-60 Terminal X30/8 Output

Option: **Function:**

[0] *	No operation
[100]	Output freq. 0-100
[101]	Reference Min-Max
[102]	Feedback +-200%
[103]	Motor cur. 0-Imax
[104]	Torque 0-Tlim
[105]	Torque 0-Tnom
[106]	Power 0-Pnom
[107]	Speed 0-HighLim
[113]	Ext. Closed Loop 1
[114]	Ext. Closed Loop 2
[115]	Ext. Closed Loop 3
[130]	Out frq 0-100 4-20mA
[131]	Reference 4-20mA
[132]	Feedback 4-20mA
[133]	Motor cur. 4-20mA
[134]	Torq.0-lim 4-20 mA
[135]	Torq.0-nom 4-20mA
[136]	Power 4-20mA
[137]	Speed 4-20mA
[139]	Bus ctrl.
[140]	Bus ctrl. 4-20 mA
[141]	Bus ctrl t.o.
[142]	Bus ctrl t.o. 4-20mA
[143]	Ext. CL 1 4-20mA
[144]	Ext. CL 2 4-20mA
[145]	Ext. CL 3 4-20mA

6-61 Terminal X30/8 Min. Scale

Range: **Function:**

0.00 %* [0.00 - 200.00 %]	<p>Scales the minimum output of the selected analog signal on terminal X30/8. Scale the minimum value as a percentage of the maximum signal value, i.e. 0 mA (or 0 Hz) is desired at 25% of the maximum output value and 25% is programmed. The value can never be higher than the corresponding setting in par. 6-62 <i>Terminal X30/8 Max. Scale</i> if value is below 100%.</p> <p>This parameter is active when option module MCB 101 is mounted in the frequency converter.</p>
---------------------------	--

6-62 Terminal X30/8 Max. Scale

Range: **Function:**

100.00 %* [0.00 - 200.00 %]	<p>Scales the maximum output of the selected analog signal on terminal X30/8. Scale the value to the desired maximum value of the current signal output. Scale the output to give a lower current than 20 mA at full scale or 20 mA at an output below 100% of the maximum signal value. If 20 mA is the desired output current at a value between 0 - 100% of the full-scale output, program the percentage value in the parameter, i.e. 50% = 20 mA. If a current between 4 and 20 mA is desired at maximum output (100%), calculate the percentage value as follows:</p> $20 \text{ mA} \text{desired maximum current} \times 100 \%$ <p>i.e. 10 mA : $\frac{20 \text{ mA}}{10 \text{ mA}} \times 100 \% = 200 \%$</p>
-----------------------------	--

6-63 Terminal X30/8 Output Bus Control

Range:

0.00 %* [0.00 - 100.00 %]

Function:

Contains the value to apply to the output terminal, when it is configured as [Bus Controlled].

6-64 Terminal X30/8 Output Timeout Preset

Range:

0.00 %* [0.00 - 100.00 %]

Function:

Contains the value to apply to the output terminal, when it is configured as [Bus Controlled Timeout] and timeout is detected.

3.9 Main Menu - Communications and Options - Group 8

3.9.1 8-** Comm. and Options

Parameter group for configuring communications and options.

3.9.2 8-0* General Settings

General settings for communications and options.

8-01 Control Site

Option:

- [0] * Digital and ctrl.word
- [1] Digital only
- [2] Controlword only

Function:

The setting in this parameter overrides the settings in par. 8-50 *Coasting Select* to par. 8-56 *Preset Reference Select*.

- Control by using both digital input and control word.
- Control by using digital inputs only.
- Control by using control word only.

8-02 Control Source

Option:

- [0] None
- [1] FC Port
- [2] USB Port
- [3] * Option A
- [4] Option B
- [5] Option C0
- [6] Option C1
- [30] External Can

Function:

Select the source of the control word: one of two serial interfaces or four installed options. During initial power-up, the frequency converter automatically sets this parameter to *Option A* [3] if it detects a valid fieldbus option installed in slot A. If the option is removed, the frequency converter detects a change in the configuration, sets par. 8-02 *Control Source* back to default setting *FC Port*, and the frequency converter then trips. If an option is installed after initial power-up, the setting of par. 8-02 *Control Source* will not change but the frequency converter will trip and display: *Alarm 67 Option Changed*.



NB!

This parameter cannot be adjusted while the motor is running.

8-03 Control Timeout Time

Range:

60.0 s* [1.0 - 18000.0 s]

Function:

Enter the maximum time expected to pass between the reception of two consecutive telegrams. If this time is exceeded, it indicates that the serial communication has stopped. The function selected in par. 8-04 *Control Timeout Function Control Time-out Function* will then be carried out.

In LonWorks the following variables will trigger the Control Word Time parameter:

nviStartStop
 nviReset Fault
 nviControlWord
 nviDrvSpeedStpt
 nviRefPcnt
 nviRefHz

8-04 Control Timeout Function

Option:
Function:

Select the time-out function. The time-out function is activated when the control word fails to be updated within the time period specified in par. 8-03 *Control Timeout Time*. Choice [20] only appears after setting the N2 protocol.

[0] *	Off
[1]	Freeze output
[2]	Stop
[3]	Jogging
[4]	Max. speed
[5]	Stop and trip
[7]	Select setup 1
[8]	Select setup 2
[9]	Select setup 3
[10]	Select setup 4
[20]	N2 Override Release

In LonWorks, the time-out function is also activated when the following SNVT's fail to be updated within the time period specified in par. 8-03 *Control Timeout Time*:

nviStartStop	nviDrvSpeedStpt
nviReset Fault	nviRefPcnt
nviControlWord	nviRefHz

8-05 End-of-Timeout Function

Option:
Function:

Select the action after receiving a valid control word following a time-out. This parameter is active only when par. 8-04 *Control Timeout Function* is set to [Set-up 1-4].

[0]	Hold set-up	Retains the set-up selected in par. 8-04 <i>Control Timeout Function</i> and displays a warning, until par. 8-06 <i>Reset Control Timeout</i> toggles. Then the frequency converter resumes its original set-up.
[1] *	Resume set-up	Resumes the set-up active prior to the time-out.

8-06 Reset Control Timeout**Option:****Function:**

Option:	Function:
	This parameter is active only when the choice <i>Hold set-up</i> [0] has been selected in par. 8-05 <i>End-of-Timeout Function</i> .
[0] * Do not reset	Retains the set-up specified in par. 8-04 <i>Control Timeout Function</i> , [Select setup 1-4] following a control time-out.
[1] Do reset	Returns the frequency converter to the original set-up following a control word time-out. When the value is set to <i>Do reset</i> [1], the frequency converter performs the reset and then immediately reverts to the <i>Do not reset</i> [0] setting.

8-07 Diagnosis Trigger**Option:****Function:**

Option:	Function:
	This parameter has no function for LonWorks.
[0] * Disable	
[1] Trigger on alarms	
[2] Trigger alarm/warn.	

3.9.3 8-1* Ctrl. Word Settings

Parameters for configuring the option control word profile.

8-10 Control Profile**Option:****Function:**

Option:	Function:
	Select the interpretation of the control and status words corresponding to the installed fieldbus. Only the selections valid for the fieldbus installed in slot A will be visible in the LCP display.
[0] * FC profile	
[1] PROFIdrive profile	
[5] ODVA	
[7] CANopen DSP 402	

8-13 Configurable Status Word STW**Option:****Function:**

Option:	Function:
	This parameter enables configuration of bits 12 – 15 in the status word.
[0] No function	
[1] * Profile Default	Function corresponds to the profile default selected in par. 8-10 <i>Control Profile</i> .
[2] Alarm 68 Only	Only set in case of an Alarm 68.
[3] Trip excl Alarm 68	Set in case of a trip, except if the trip is executed by an Alarm 68.
[16] T37 DI status	The bit indicates the status of terminal 37. "0" indicates T37 is low (safe stop) "1" indicates T37 is high (normal)

3.9.4 8-3* FC Port Settings

Parameters for configuring the FC Port.

8-30 Protocol

Option:

Function:

		Protocol selection for the integrated FC (standard) Port (RS485) on the control card. Parameter group 8-7* is only visible when FC Option [9] is chosen.
[0] *	FC	Communication according to the FC Protocol as described in the <i>VLT HVAC Drive Design Guide, RS-485 Installation and Set-up</i> .
[1]	FC MC	Same as FC [0] but to be used when downloading SW to the frequency converter or uploading dll file (covering information regarding parameters available in the frequency converter and their inter-dependencies) to Motion Control Tool MCT10.
[2]	Modbus RTU	Communication according to the Modbus RTU protocol as described in the <i>VLT HVAC Drive Design Guide, RS-485 Installation and Set-up</i> .
[3]	Metasys N2	Communication protocol. The N2 software protocol is designed to be general in nature in order to accommodate the unique properties each device may have. Please see separate manual <i>VLT HVAC Drive Metasys, MG.11.Gx.yy</i> .
[9]	FC Option	To be used when a gateway is connected to the integrated RS-485 port, e.g. the BACnet gateway. Following changes will take place: -Address for the FC port will be set to 1 and par. 8-31 <i>Address</i> , is now used to set the address for the gateway on the network, e.g. BACnet. Please see separate manual <i>VLT HVAC Drive BACnet, MG.11.Dx.yy</i> . -Baud rate for the FC port will be set to a fixed value (115.200 Baud) and par. 8-32 <i>Baud Rate</i> , is now used to set the baud rate for the network port (e.g. BACnet) on the gateway.
[20]	LEN	

**NB!**

Further details can be found in the BACnet and Metasys manuals.

8-31 Address

Range:

Function:

1. N/A*	[1. - 126. N/A]	Enter the address for the FC (standard) port. Valid range: 1 - 126.
---------	-----------------	--

8-32 Baud Rate

Option:

Function:

		Baud rate selection depends on Protocol selection in par. 8-30 <i>Protocol</i> .
[0]	2400 Baud	
[1]	4800 Baud	
[2] *	9600 Baud	
[3]	19200 Baud	
[4]	38400 Baud	
[5]	57600 Baud	
[6]	76800 Baud	
[7]	115200 Baud	

Default refers to the FC Protocol.

8-33 Parity / Stop Bits**Option:****Function:**

Parity and Stop Bits for the protocol par. 8-30 *Protocol* using the FC Port. For some of the protocols, not all options will be visible. Default depends on the protocol selected.

[0] * Even Parity, 1 Stop Bit

[1] Odd Parity, 1 Stop Bit

[2] No Parity, 1 Stop Bit

[3] No Parity, 2 Stop Bits

8-35 Minimum Response Delay**Range:****Function:**

10. ms* [5. - 10000. ms]

Specify the minimum delay time between receiving a request and transmitting a response. This is used for overcoming modem turnaround delays.

8-36 Maximum Response Delay**Range:****Function:**

10001. ms* [11. - 10001. ms]

Specify the maximum permissible delay time between transmitting a request and receiving a response. Exceeding this delay time will cause control word time-out.

8-37 Maximum Inter-Char Delay**Range:****Function:**

25.00 ms* [0.00 - 35.00 ms]

Specify the maximum permissible time interval between receipt of two bytes. This parameter activates time-out if transmission is interrupted.

8-40 Telegram Selection**Option:****Function:**

Enables use of freely configurable telegrams or standard telegrams for the FC port.

[1] * Standard telegram 1

[101] PPO 1

[102] PPO 2

[103] PPO 3

[104] PPO 4

[105] PPO 5

[106] PPO 6

[107] PPO 7

[108] PPO 8

[200] Custom telegram 1

3.9.5 8-5* Digital/Bus

Parameters for configuring the control word Digital/Bus merging.

8-50 Coasting Select**Option:****Function:**

Select control of the coasting function via the terminals (digital input) and/or via the bus.

[0] Digital input

[1] Bus

[2] Logic AND

[3] * Logic OR

**NB!**

This parameter is active only when par. 8-01 *Control Site* is set to [0] *Digital and control word*.

8-52 DC Brake Select

Option:**Function:**

Select control of the DC brake via the terminals (digital input) and/or via the fieldbus.

[0] Digital input

[1] Bus

[2] Logic AND

[3] * Logic OR

**NB!**

This parameter is active only when par. 8-01 *Control Site* is set to [0] *Digital and control word*.

8-53 Start Select

Option:**Function:**

Select control of the frequency converter start function via the terminals (digital input) and/or via the fieldbus.

[0] Digital input

Activates Start command via a digital input.

[1] Bus

Activates Start command via the serial communication port or fieldbus option.

[2] Logic AND

Activates Start command via the fieldbus/serial communication port, AND additionally via one of the digital inputs.

[3] * Logic OR

Activates Start command via the fieldbus/serial communication port OR via one of the digital inputs.

**NB!**

This parameter is active only when par. 8-01 *Control Site* is set to [0] *Digital and control word*.

8-54 Reversing Select

Option:**Function:**

Select control of the frequency converter reverse function via the terminals (digital input) and/or via the fieldbus.

[0] * Digital input

Activates Reverse command via a digital input.

[1] Bus

Activates Reverse command via the serial communication port or fieldbus option.

[2] Logic AND

Activates Reverse command via the fieldbus/serial communication port, AND additionally via one of the digital inputs.

[3] Logic OR

Activates Reverse command via the fieldbus/serial communication port OR via one of the digital inputs.

**NB!**

This parameter is active only when par. 8-01 *Control Site* is set to [0] *Digital and control word*.

8-55 Set-up Select

Option:	Function:
	Select control of the frequency converter set-up selection via the terminals (digital input) and/or via the fieldbus.
[0] Digital input	Activates the set-up selection via a digital input.
[1] Bus	Activates the set-up selection via the serial communication port or fieldbus option.
[2] Logic AND	Activates the set-up selection via the fieldbus/serial communication port, AND additionally via one of the digital inputs.
[3] * Logic OR	Activate the set-up selection via the fieldbus/serial communication port OR via one of the digital inputs.

 **NB!**
 This parameter is active only when par. 8-01 *Control Site* is set to [0] *Digital and control word*.

8-56 Preset Reference Select

Option:	Function:
	Select control of the frequency converter Preset Reference selection via the terminals (digital input) and/or via the fieldbus.
[0] Digital input	Activates Preset Reference selection via a digital input.
[1] Bus	Activates Preset Reference selection via the serial communication port or fieldbus option.
[2] Logic AND	Activates Preset Reference selection via the fieldbus/serial communication port, AND additionally via one of the digital inputs.
[3] * Logic OR	Activates the Preset Reference selection via the fieldbus/serial communication port OR via one of the digital inputs.

 **NB!**
 This parameter is active only when par. 8-01 *Control Site* is set to [0] *Digital and control word*.

3.9.6 8-7* BACnet

BACnet configuration

8-70 BACnet Device Instance

Range:	Function:
1 N/A* [0 - 4194304 N/A]	Enter a unique ID number for the BACnet device.

 **NB!**
 This parameter is active only when par. 8-30 *Protocol* is set to [9] *FC Option*.

8-72 MS/TP Max Masters

Range:	Function:
127 N/A* [0 - 127 N/A]	Define the address of the master which holds the highest address in this network. Decreasing this value optimises polling for the token.

**NB!**

This parameter is active only when par. 8-30 *Protocol* is set to [9] *FC Option*.

8-73 MS/TP Max Info Frames**Range:**

1 N/A* [1 - 65534 N/A]

Function:

Define how many info/data frames the device is allowed to send while holding the token.

**NB!**

This parameter is active only when par. 8-30 *Protocol* is set to [9] *FC Option*.

8-74 "I-Am" Service**Option:**

[0] * Send at power-up

Function:

[1] Continuously

Choose whether the device should send the "I-Am" service message only at power-up or continuously with an interval of approx. 1 min.

**NB!**

This parameter is active only when par. 8-30 *Protocol* is set to [9] *FC Option*.

8-75 Initialisation Password**Range:**

0 N/A* [0 - 0 N/A]

Function:

Enter the password needed for execution of Drive Re-initialisation from BACnet.

**NB!**

This parameter is active only when par. 8-30 *Protocol* is set to [9] *FC Option*.

3.9.7 8-8* FC Port Diagnostics

These parameters are used for monitoring the Bus communication via the FC Port.

8-80 Bus Message Count**Range:**

0 N/A* [0 - 0 N/A]

Function:

This parameter shows the number of valid telegrams detected on the bus.

8-81 Bus Error Count**Range:**

0 N/A* [0 - 0 N/A]

Function:

This parameter shows the number of telegrams with faults (e.g. CRC fault), detected on the bus.

8-82 Slave Messages Rcvd**Range:**

0 N/A* [0 - 0 N/A]

Function:

This parameter shows the number of valid telegrams addressed to the slave, sent by the frequency converter.

8-83 Slave Error Count**Range:**

0 N/A* [0 - 0 N/A]

Function:

This parameter shows the number of error telegrams, which could not be executed by the frequency converter.

3.9.8 8-9* Bus Jog

Parameters for configuring the Bus Jog.

8-90 Bus Jog 1 Speed**Range:**

100 RPM* [0 - par. 4-13 RPM]

Function:

Enter the jog speed. This is a fixed jog speed activated via the serial port or fieldbus option.

8-91 Bus Jog 2 Speed**Range:**

200 RPM* [0 - par. 4-13 RPM]

Function:

Enter the jog speed. This is a fixed jog speed activated via the serial port or fieldbus option.

8-94 Bus Feedback 1**Range:**

0 N/A* [-200 - 200 N/A]

Function:Write a feedback to this parameter via the serial communication port or fieldbus option. This parameter must be selected in par. 20-00 *Feedback 1 Source*, par. 20-03 *Feedback 2 Source* or par. 20-06 *Feedback 3 Source* as a feedback source.**8-95 Bus Feedback 2****Range:**

0 N/A* [-200 - 200 N/A]

Function:See par. 8-94 *Bus Feedback 1* for further details.**8-96 Bus Feedback 3****Range:**

0 N/A* [-200 - 200 N/A]

Function:See par. 8-94 *Bus Feedback 1* for further details.**3.10 Main Menu - Profibus - Group 9****3.10.1 9-*** Profibus**

Parameter group for all Profibus-specific parameters.

9-15 PCD Write Configuration

Array [10]

Option:**Function:**

Select the parameters to be assigned to PCD 3 to 10 of the telegrams. The number of available PCDs depends on the telegram type. The values in PCD 3 to 10 will then be written to the selected parameters as data values. Alternatively, specify a standard Profibus telegram in par. 9-22 *Telegram Selection*.

[0] *	None
[302]	Minimum Reference
[303]	Maximum Reference
[341]	Ramp 1 Ramp Up Time
[342]	Ramp 1 Ramp Down Time
[351]	Ramp 2 Ramp Up Time
[352]	Ramp 2 Ramp Down Time
[380]	Jog Ramp Time
[381]	Quick Stop Ramp Time
[411]	Motor Speed Low Limit [RPM]
[413]	Motor Speed High Limit [RPM]
[416]	Torque Limit Motor Mode
[417]	Torque Limit Generator Mode
[590]	Digital & Relay Bus Control
[593]	Pulse Out #27 Bus Control
[595]	Pulse Out #29 Bus Control
[597]	Pulse Out #X30/6 Bus Control
[653]	Terminal 42 Output Bus Control
[663]	Terminal X30/8 Output Bus Control
[890]	Bus Jog 1 Speed
[891]	Bus Jog 2 Speed
[894]	Bus Feedback 1
[895]	Bus Feedback 2
[896]	Bus Feedback 3
[1680]	Fieldbus CTW 1
[1682]	Fieldbus REF 1
[2013]	Minimum Reference/Feedb.
[2014]	Maximum Reference/Feedb.
[2643]	Terminal X42/7 Bus Control
[2653]	Terminal X42/9 Bus Control
[2663]	Terminal X42/11 Bus Control

9-16 PCD Read Configuration

Array [10]

Option:**Function:**

Select the parameters to be assigned to PCD 3 to 10 of the telegrams. The number of available PCDs depends on the telegram type. PCDs 3 to 10 contain the actual data values of the selected parameters. For standard Profibus telegrams, see par. 9-22 *Telegram Selection*.

[0] *	None
[894]	Bus Feedback 1
[895]	Bus Feedback 2

[896]	Bus Feedback 3
[1600]	Control Word
[1601]	Reference [Unit]
[1602]	Reference [%]
[1603]	Status Word
[1605]	Main Actual Value [%]
[1609]	Custom Readout
[1610]	Power [kW]
[1611]	Power [hp]
[1612]	Motor Voltage
[1613]	Frequency
[1614]	Motor Current
[1615]	Frequency [%]
[1616]	Torque [Nm]
[1617]	Speed [RPM]
[1618]	Motor Thermal
[1622]	Torque [%]
[1630]	DC Link Voltage
[1632]	Brake Energy /s
[1633]	Brake Energy /2 min
[1634]	Heatsink Temp.
[1635]	Inverter Thermal
[1638]	SL Controller State
[1639]	Control Card Temp.
[1650]	External Reference
[1652]	Feedback [Unit]
[1653]	Digi Pot Reference
[1654]	Feedback 1 [Unit]
[1655]	Feedback 2 [Unit]
[1656]	Feedback 3 [Unit]
[1660]	Digital Input
[1661]	Terminal 53 Switch Setting
[1662]	Analog Input 53
[1663]	Terminal 54 Switch Setting
[1664]	Analog Input 54
[1665]	Analog Output 42 [mA]
[1666]	Digital Output [bin]
[1667]	Pulse Input #29 [Hz]
[1668]	Pulse Input #33 [Hz]
[1669]	Pulse Output #27 [Hz]
[1670]	Pulse Output #29 [Hz]
[1671]	Relay Output [bin]
[1672]	Counter A
[1673]	Counter B
[1675]	Analog In X30/11
[1676]	Analog In X30/12
[1677]	Analog Out X30/8 [mA]

[1684]	Comm. Option STW
[1685]	FC Port CTW 1
[1690]	Alarm Word
[1691]	Alarm Word 2
[1692]	Warning Word
[1693]	Warning Word 2
[1694]	Ext. Status Word
[1695]	Ext. Status Word 2
[1696]	Maintenance Word
[1830]	Analog Input X42/1
[1831]	Analog Input X42/3
[1832]	Analog Input X42/5
[1833]	Analog Out X42/7 [V]
[1834]	Analog Out X42/9 [V]
[1835]	Analog Out X42/11 [V]

9-18 Node Address

Range:

126 N/A* [0 - 126. N/A]

Function:

Enter the station address in this parameter or alternatively in the hardware switch. In order to adjust the station address in par. 9-18 *Node Address*, the hardware switch must be set to 126 or 127 (i.e. all switches set to 'on'). Otherwise this parameter will display the actual setting of the switch.

9-22 Telegram Selection

Option:

[1]	Standard telegram 1
[101]	PPO 1
[102]	PPO 2
[103]	PPO 3
[104]	PPO 4
[105]	PPO 5
[106]	PPO 6
[107]	PPO 7
[108] *	PPO 8
[200]	Custom telegram 1

Function:

Select a standard Profibus telegram configuration for the frequency converter, as an alternative to using the freely configurable telegrams in par. 9-15 *PCD Write Configuration* and par. 9-16 *PCD Read Configuration*.

9-23 Parameters for Signals

Array [1000]

Option:

[0] *	None
[302]	Minimum Reference
[303]	Maximum Reference
[341]	Ramp 1 Ramp Up Time
[342]	Ramp 1 Ramp Down Time
[351]	Ramp 2 Ramp Up Time

Function:

This parameter contains a list of signals available for selection in par. 9-15 *PCD Write Configuration* and par. 9-16 *PCD Read Configuration*.

[352]	Ramp 2 Ramp Down Time
[380]	Jog Ramp Time
[381]	Quick Stop Ramp Time
[411]	Motor Speed Low Limit [RPM]
[413]	Motor Speed High Limit [RPM]
[416]	Torque Limit Motor Mode
[417]	Torque Limit Generator Mode
[590]	Digital & Relay Bus Control
[593]	Pulse Out #27 Bus Control
[595]	Pulse Out #29 Bus Control
[597]	Pulse Out #X30/6 Bus Control
[653]	Terminal 42 Output Bus Control
[663]	Terminal X30/8 Output Bus Control
[890]	Bus Jog 1 Speed
[891]	Bus Jog 2 Speed
[894]	Bus Feedback 1
[895]	Bus Feedback 2
[896]	Bus Feedback 3
[1600]	Control Word
[1601]	Reference [Unit]
[1602]	Reference [%]
[1603]	Status Word
[1605]	Main Actual Value [%]
[1609]	Custom Readout
[1610]	Power [kW]
[1611]	Power [hp]
[1612]	Motor Voltage
[1613]	Frequency
[1614]	Motor Current
[1615]	Frequency [%]
[1616]	Torque [Nm]
[1617]	Speed [RPM]
[1618]	Motor Thermal
[1622]	Torque [%]
[1630]	DC Link Voltage
[1632]	Brake Energy /s
[1633]	Brake Energy /2 min
[1634]	Heatsink Temp.
[1635]	Inverter Thermal
[1638]	SL Controller State
[1639]	Control Card Temp.
[1650]	External Reference
[1652]	Feedback [Unit]
[1653]	Digi Pot Reference
[1654]	Feedback 1 [Unit]
[1655]	Feedback 2 [Unit]
[1656]	Feedback 3 [Unit]

[1660]	Digital Input
[1661]	Terminal 53 Switch Setting
[1662]	Analog Input 53
[1663]	Terminal 54 Switch Setting
[1664]	Analog Input 54
[1665]	Analog Output 42 [mA]
[1666]	Digital Output [bin]
[1667]	Pulse Input #29 [Hz]
[1668]	Pulse Input #33 [Hz]
[1669]	Pulse Output #27 [Hz]
[1670]	Pulse Output #29 [Hz]
[1671]	Relay Output [bin]
[1672]	Counter A
[1673]	Counter B
[1675]	Analog In X30/11
[1676]	Analog In X30/12
[1677]	Analog Out X30/8 [mA]
[1680]	Fieldbus CTW 1
[1682]	Fieldbus REF 1
[1684]	Comm. Option STW
[1685]	FC Port CTW 1
[1690]	Alarm Word
[1691]	Alarm Word 2
[1692]	Warning Word
[1693]	Warning Word 2
[1694]	Ext. Status Word
[1695]	Ext. Status Word 2
[1696]	Maintenance Word
[1830]	Analog Input X42/1
[1831]	Analog Input X42/3
[1832]	Analog Input X42/5
[1833]	Analog Out X42/7 [V]
[1834]	Analog Out X42/9 [V]
[1835]	Analog Out X42/11 [V]
[2013]	Minimum Reference/Feedb.
[2014]	Maximum Reference/Feedb.
[2643]	Terminal X42/7 Bus Control
[2653]	Terminal X42/9 Bus Control
[2663]	Terminal X42/11 Bus Control

9-27 Parameter Edit

Option:
Function:

Parameters can be edited via Profibus, the standard RS485 interface, or the LCP.

[0]	Disabled	Disables editing via Profibus.
[1] *	Enabled	Enables editing via Profibus.

9-28 Process Control

Option:

Function:

Process control (setting of Control Word, speed reference, and process data) is possible via either Profibus or standard fieldbus but not both simultaneously. Local control is always possible via the LCP. Control via process control is possible via either terminals or fieldbus depending on the settings in par. 8-50 *Coasting Select* to par. 8-56 *Preset Reference Select*.

[0]	Disable	Disables process control via Profibus, and enables process control via standard fieldbus or Profibus Master class 2.
[1] *	Enable cyclic master	Enables process control via Profibus Master Class 1, and disables process control via standard fieldbus or Profibus Master class 2.

9-53 Profibus Warning Word

Range:

Function:

0 N/A* [0 - 65535 N/A] This parameter displays Profibus communication warnings. Please refer to the *Profibus Operating Instructions* for further information.

Read only

Bit:	Meaning:
0	Connection with DP-master is not ok
1	Not used
2	FDL (Field-bus Data link Layer) is not ok
3	Clear data command received
4	Actual value is not updated
5	Baudrate search
6	PROFIBUS ASIC is not transmitting
7	Initializing of PROFIBUS is not ok
8	Frequency converter is tripped
9	Internal CAN error
10	Wrong configuration data from PLC
11	Wrong ID sent by PLC
12	Internal error occurred
13	Not configured
14	Timeout active
15	Warning 34 active

9-63 Actual Baud Rate

Option:

Function:

This parameter displays the actual Profibus baud rate. The Profibus Master automatically sets the baud rate.

[0]	9,6 kbit/s
[1]	19,2 kbit/s
[2]	93,75 kbit/s
[3]	187,5 kbit/s
[4]	500 kbit/s
[6]	1500 kbit/s
[7]	3000 kbit/s
[8]	6000 kbit/s
[9]	12000 kbit/s
[10]	31,25 kbit/s
[11]	45,45 kbit/s
[255] *	No baudrate found

9-65 Profile Number

Range:

0 N/A* [0 - 0 N/A]

Function:

This parameter contains the profile identification. Byte 1 contains the profile number and byte 2 the version number of the profile.

NB!

This parameter is not visible via LCP.

9-70 Programming Set-up

Option:

[0] Factory setup

[1] Set-up 1

[2] Set-up 2

[3] Set-up 3

[4] Set-up 4

[9] * Active Set-up

Function:

Select the set-up to be edited.

Uses default data. This option can be used as a data source to return the other set-ups to a known state.

Edits Set-up 1.

Edits Set-up 2.

Edits Set-up 3.

Edits Set-up 4.

Follows the active set-up selected in par. 0-10 *Active Set-up*.

This parameter is unique to LCP and fieldbuses. See also par. 0-11 *Programming Set-up*.

9-71 Profibus Save Data Values

Option:

[0] * Off

[1] Store all setups

[2] Store all setups

Function:

Parameter values changed via Profibus are not automatically stored in non-volatile memory. Use this parameter to activate a function that stores parameter values in the EEPROM non-volatile memory, so changed parameter values will be retained at power-down.

Deactivates the non-volatile storage function.

Stores all parameter values for all set-ups in the non-volatile memory. The selection returns to *Off*[0] when all parameter values have been stored.

9-72 ProfibusDriveReset

Option:

[0] * No action

[1] Power-on reset

[3] Comm option reset

Function:

Resets frequency converter upon power-up, as for power-cycle.

Resets the Profibus option only, useful after changing certain settings in parameter group 9-**, e.g. par. 9-18 *Node Address*.
When reset, the frequency converter disappears from the fieldbus, which may cause a communication error from the master.

9-80 Defined Parameters (1)

Array [116]

No LCP access

Read only

Range:

0 N/A* [0 - 9999 N/A]

Function:

This parameter displays a list of all the defined frequency converter parameters available for Profibus.

9-81 Defined Parameters (2)

Array [116]
 No LCP access
 Read only

Range:

0 N/A* [0 - 9999 N/A]

Function:

This parameter displays a list of all the defined frequency converter parameters available for Profibus.

9-82 Defined Parameters (3)

Array [116]
 No LCP access
 Read only

Range:

0 N/A* [0 - 9999 N/A]

Function:

This parameter displays a list of all the defined frequency converter parameters available for Profibus.

9-83 Defined Parameters (4)

Array [116]
 No LCP access
 Read only

Range:

0 N/A* [0 - 9999 N/A]

Function:

This parameter displays a list of all the defined frequency converter parameters available for Profibus.

9-90 Changed Parameters (1)

Array [116]
 No LCP access
 Read only

Range:

0 N/A* [0 - 9999 N/A]

Function:

This parameter displays a list of all the frequency converter parameters deviating from default setting.

9-91 Changed Parameters (2)

Array [116]
 No LCP access
 Read only

Range:

0 N/A* [0 - 9999 N/A]

Function:

This parameter displays a list of all the frequency converter parameters deviating from default setting.

9-92 Changed Parameters (3)

Array [116]
 No LCP access
 Read only

Range:

0 N/A* [0 - 9999 N/A]

Function:

This parameter displays a list of all the frequency converter parameters deviating from default setting.

9-94 Changed Parameters (5)

Array [116]

No LCP Address

Read only

Range:

0 N/A* [0 - 9999 N/A]

Function:

This parameter displays a list of all the frequency converter parameters deviating from default setting.

3.11 Main Menu - CAN Fieldbus - Group 10

3.11.1 10-** DeviceNet and CAN Fieldbus

Parameter group for DeviceNet CAN fieldbus parameters.

3.11.2 10-0* Common Settings

Parameter group for configuring common settings for CAN fieldbus options.

10-00 CAN Protocol

Option:

[1] * DeviceNet

Function:

View the active CAN protocol.

**NB!**

The options depend on installed option

10-01 Baud Rate Select

Option:

[16] 10 Kbps

[17] 20 Kbps

[18] 50 Kbps

[19] 100 Kbps

[20] * 125 Kbps

[21] 250 Kbps

[22] 500 Kbps

[23] 800 Kbps

[24] 1000 Kbps

Function:

Select the fieldbus transmission speed. The selection must correspond to the transmission speed of the master and the other fieldbus nodes.

10-02 MAC ID

Range:

63. N/A* [0 - 63. N/A]

Function:

Selection of station address. Every station connected to the same DeviceNet network must have an unambiguous address.

10-05 Readout Transmit Error Counter

Range:

0 N/A* [0 - 255 N/A]

Function:

View the number of CAN control transmission errors since the last power-up.

10-06 Readout Receive Error Counter

Range:	Function:
0 N/A* [0 - 255 N/A]	View the number of CAN control receipt errors since the last power-up.

10-07 Readout Bus Off Counter

Range:	Function:
0 N/A* [0 - 255 N/A]	View the number of Bus Off events since the last power-up.

3.11.3 10-1 * DeviceNet

Parameters specific to the DeviceNet fieldbus.

10-10 Process Data Type Selection

Option:	Function:
	<p>Select the Instance (telegram) for data transmission. The Instances available are dependent upon the setting of par. 8-10 <i>Control Profile</i>.</p> <p>When par. 8-10 <i>Control Profile</i> is set to [0] <i>FC profile</i>, par. 10-10 <i>Process Data Type Selection</i> options [0] and [1] are available.</p> <p>When par. 8-10 <i>Control Profile</i> is set to [5] <i>ODVA</i>, par. 10-10 <i>Process Data Type Selection</i> options [2] and [3] are available.</p> <p>Instances 100/150 and 101/151 are Danfoss-specific. Instances 20/70 and 21/71 are ODVA-specific AC Drive profiles.</p> <p>For guidelines in telegram selection, please refer to the DeviceNet Operating Instructions.</p> <p>Note that a change to this parameter will be executed immediately.</p>

[0] *	INSTANCE 100/150
[1]	INSTANCE 101/151
[2]	INSTANCE 20/70
[3]	INSTANCE 21/71

10-11 Process Data Config Write

Option:	Function:
	Select the process write data for I/O Assembly Instances 101/151. Elements [2] and [3] of this array can be selected. Elements [0] and [1] of the array are fixed.
[0] *	None
[302]	Minimum Reference
[303]	Maximum Reference
[341]	Ramp 1 Ramp Up Time
[342]	Ramp 1 Ramp Down Time
[351]	Ramp 2 Ramp Up Time
[352]	Ramp 2 Ramp Down Time
[380]	Jog Ramp Time
[381]	Quick Stop Ramp Time
[411]	Motor Speed Low Limit [RPM]
[413]	Motor Speed High Limit [RPM]
[416]	Torque Limit Motor Mode
[417]	Torque Limit Generator Mode
[590]	Digital & Relay Bus Control
[593]	Pulse Out #27 Bus Control
[595]	Pulse Out #29 Bus Control

[597]	Pulse Out #X30/6 Bus Control
[653]	Terminal 42 Output Bus Control
[663]	Terminal X30/8 Output Bus Control
[890]	Bus Jog 1 Speed
[891]	Bus Jog 2 Speed
[894]	Bus Feedback 1
[895]	Bus Feedback 2
[896]	Bus Feedback 3
[1680]	Fieldbus CTW 1
[1682]	Fieldbus REF 1
[2013]	Minimum Reference/Feedb.
[2014]	Maximum Reference/Feedb.
[2643]	Terminal X42/7 Bus Control
[2653]	Terminal X42/9 Bus Control
[2663]	Terminal X42/11 Bus Control

10-12 Process Data Config Read

Option:

Function:

Select the process read data for I/O Assembly Instances 101/151. Elements [2] and [3] of this array can be selected. Elements [0] and [1] of the array are fixed.

[0] *	None
[894]	Bus Feedback 1
[895]	Bus Feedback 2
[896]	Bus Feedback 3
[1600]	Control Word
[1601]	Reference [Unit]
[1602]	Reference [%]
[1603]	Status Word
[1605]	Main Actual Value [%]
[1609]	Custom Readout
[1610]	Power [kW]
[1611]	Power [hp]
[1612]	Motor Voltage
[1613]	Frequency
[1614]	Motor Current
[1615]	Frequency [%]
[1616]	Torque [Nm]
[1617]	Speed [RPM]
[1618]	Motor Thermal
[1622]	Torque [%]
[1630]	DC Link Voltage
[1632]	Brake Energy /s
[1633]	Brake Energy /2 min
[1634]	Heatsink Temp.
[1635]	Inverter Thermal
[1638]	SL Controller State
[1639]	Control Card Temp.

[1650]	External Reference
[1652]	Feedback [Unit]
[1653]	Digi Pot Reference
[1654]	Feedback 1 [Unit]
[1655]	Feedback 2 [Unit]
[1656]	Feedback 3 [Unit]
[1660]	Digital Input
[1661]	Terminal 53 Switch Setting
[1662]	Analog Input 53
[1663]	Terminal 54 Switch Setting
[1664]	Analog Input 54
[1665]	Analog Output 42 [mA]
[1666]	Digital Output [bin]
[1667]	Pulse Input #29 [Hz]
[1668]	Pulse Input #33 [Hz]
[1669]	Pulse Output #27 [Hz]
[1670]	Pulse Output #29 [Hz]
[1671]	Relay Output [bin]
[1672]	Counter A
[1673]	Counter B
[1675]	Analog In X30/11
[1676]	Analog In X30/12
[1677]	Analog Out X30/8 [mA]
[1684]	Comm. Option STW
[1685]	FC Port CTW 1
[1690]	Alarm Word
[1691]	Alarm Word 2
[1692]	Warning Word
[1693]	Warning Word 2
[1694]	Ext. Status Word
[1695]	Ext. Status Word 2
[1696]	Maintenance Word
[1830]	Analog Input X42/1
[1831]	Analog Input X42/3
[1832]	Analog Input X42/5
[1833]	Analog Out X42/7 [V]
[1834]	Analog Out X42/9 [V]
[1835]	Analog Out X42/11 [V]

10-13 Warning Parameter

Range:

0 N/A* [0 - 65535 N/A]

Function:

View a DeviceNet-specific Warning word. One bit is assigned to every warning. Please refer to the DeviceNet Operating Instructions (MG.33.DX.YY) for further information.

Bit:	Meaning:
0	Bus not active
1	Explicit connection timeout
2	I/O connection
3	Retry limit reached
4	Actual is not updated
5	CAN bus off
6	I/O send error
7	Initialization error
8	No bus supply
9	Bus off
10	Error passive
11	Error warning
12	Duplicate MAC ID Error
13	RX queue overrun
14	TX queue overrun
15	CAN overrun

10-14 Net Reference

Read only from LCP

Option:
Function:

Select the reference source in Instance 21/71 and 20/70.

[0] *	Off	Enables reference via analog/digital inputs.
[1]	On	Enables reference via the fieldbus.

10-15 Net Control

Read only from LCP

Option:
Function:

Select the control source in Instance 21/71 and 20-70.

[0] *	Off	Enables control via analog/digital inputs.
[1]	On	Enable control via the fieldbus.

3.11.4 10-2* COS Filters

Parameters for configuring COS filter settings.

10-20 COS Filter 1

Range:
Function:

0 N/A* [0 - 65535 N/A]

Enter the value for COS Filter 1 to set up the filter mask for the Status Word. When operating in COS (Change-Of-State), this function filters out bits in the Status Word that should not be sent if they change.

10-21 COS Filter 2

Range:
Function:

0 N/A* [0 - 65535 N/A]

Enter the value for COS Filter 2, to set up the filter mask for the Main Actual Value. When operating in COS (Change-Of-State), this function filters out bits in the Main Actual Value that should not be sent if they change.

10-22 COS Filter 3

Range:
Function:

0 N/A* [0 - 65535 N/A]

Enter the value for COS Filter 3, to set up the filter mask for PCD 3. When operating in COS (Change-Of-State), this function filters out bits in PCD 3 that should not be sent if they change.

10-23 COS Filter 4

Range:	Function:
0 N/A* [0 - 65535 N/A]	Enter the value for COS Filter 4 to set up the filter mask for PCD 4. When operating in COS (Change-Of-State), this function filters out bits in PCD 4 that should not be sent if they change.

3.11.5 10-3* Parameter Access

Parameter group providing access to indexed parameters and defining programming set-up.

10-30 Array Index

Range:	Function:
0 N/A* [0 - 255 N/A]	View array parameters. This parameter is valid only when a DeviceNet fieldbus is installed.

10-31 Store Data Values

Option:	Function:
[0] * Off	Parameter values changed via DeviceNet are not automatically stored in non-volatile memory. Use this parameter to activate a function that stores parameter values in the EEPROM non-volatile memory, so changed parameter values will be retained at power-down. Deactivates the non-volatile storage function.
[1] Store all setups	Stores all parameter values from the active set-up in the non-volatile memory. The selection returns to Off [0] when all values have been stored.
[2] Store all setups	Stores all parameter values for all set-ups in the non-volatile memory. The selection returns to Off[0] when all parameter values have been stored.

10-32 Devicenet Revision

Range:	Function:
0 N/A* [0 - 65535 N/A]	View the DeviceNet revision number. This parameter is used for EDS file creation.

10-33 Store Always

Option:	Function:
[0] * Off	Deactivates non-volatile storage of data.
[1] On	Stores parameter data received via DeviceNet in EEPROM non-volatile memory as default.

10-39 Devicenet F Parameters

Array [1000]
No LCP access

Range:	Function:
0 N/A* [0 - 0 N/A]	This parameter is used to configure the frequency converter via DeviceNet and build the EDS-file.

3.12 Main Menu - LonWorks - Group 11

3.12.1 LonWorks, 11*

Parameter group for all LonWorks specific parameters.
Parameters related to LonWorks ID.

11-00 Neuron ID

Range:	Function:
0 N/A* [0 - 0 N/A]	View the Neuron chip's unique Neuron ID number.

11-10 Drive Profile

Option:
Function:

		This parameter allows selecting between LONMARK Functional Profiles.
[0] *	VSD profile	The Danfoss Profile and the Node Object are common for all profiles.
[1]	Pump controller	

11-15 LON Warning Word

Range:
Function:

0 N/A*	[0 - 65535 N/A]	This parameter contains the LON specific warnings.
--------	-----------------	--

Bit	Status
0	Internal fault
1	Internal fault
2	Internal fault
3	Internal fault
4	Internal fault
5	Invalid type change for nvoAnIn1
6	Invalid type change for nvoAnIn2
7	Invalid type change for nvo109AnIn1
8	Invalid type change for nvo109AnIn2
9	Invalid type change for nvo109AnIn3
10	Initialization error
11	Internal communication error
12	Software revision mismatch
13	Bus not active
14	Option not present
15	LON input (nvi/nci) exceeds limits

11-17 XIF Revision

Range:
Function:

0 N/A*	[0 - 0 N/A]	This parameter contains the version of the external interface file on the Neuron C chip on the LON option.
--------	-------------	--

11-18 LonWorks Revision

Range:
Function:

0 N/A*	[0 - 0 N/A]	This parameter contains the software version of the application program on the Neuron C chip on the LON option.
--------	-------------	---

11-21 Store Data Values

Option:
Function:

		This parameter is used to activate storing of data in non-volatile memory.
[0] *	Off	Store function is inactive.
[2]	Store all setups	Stores all parameter values in the E ² PROM. The value returns to <i>Off</i> when all parameter values have been stored.

3.13 Main Menu - Smart Logic - Group 13

3.13.1 13-** Prog. Features

Smart Logic Control (SLC) is essentially a sequence of user defined actions (see par. 13-52 *SL Controller Action* [x]) executed by the SLC when the associated user defined *event* (see par. 13-51 *SL Controller Event* [x]) is evaluated as TRUE by the SLC. Events and *actions* are each numbered and linked together in pairs. This means that when *event* [0] is fulfilled (attains the value TRUE), *action* [0] is executed. After this, the conditions of *event* [1] will

be evaluated and if evaluated TRUE, *action* [1] will be executed and so on. Only one *event* will be evaluated at any time. If an *event* is evaluated as FALSE, nothing happens (in the SLC) during the current scan interval and no other *events* will be evaluated. This means that when the SLC starts, it evaluates *event* [0] (and only *event* [0]) each scan interval. Only when *event* [0] is evaluated TRUE, will the SLC execute *action* [0] and start evaluating *event* [1]. It is possible to programme from 1 to 20 *events* and *actions*.

When the last *event* / *action* has been executed, the sequence starts over again from *event* [0] / *action* [0]. The illustration shows an example with three event / actions:

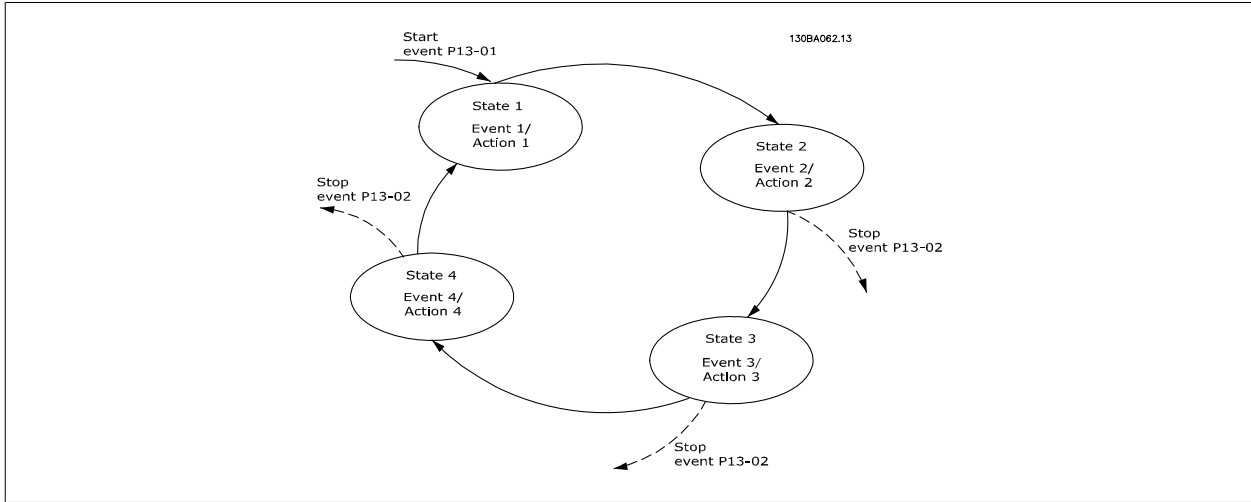

Starting and stopping the SLC:

Starting and stopping the SLC can be done by selecting *On* [1] or *Off* [0] in par. 13-00 *SL Controller Mode*. The SLC always starts in state 0 (where it evaluates *event* [0]). The SLC starts when the Start Event (defined in par. 13-01 *Start Event*) is evaluated as TRUE (provided that *On* [1] is selected in par. 13-00 *SL Controller Mode*). The SLC stops when the Stop Event (par. 13-02 *Stop Event*) is TRUE. par. 13-03 *Reset SLC* resets all SLC parameters and starts programming from scratch.

3.13.2 13-0* SLC Settings

Use the SLC settings to activate, deactivate and reset the Smart Logic Control.

13-00 SL Controller Mode

Option:	Function:
[0] * Off	Disables the Smart Logic Controller.
[1] On	Enables the Smart Logic Controller.

13-01 Start Event

Option:	Function:
	Select the boolean (TRUE or FALSE) input to activate Smart Logic Control.
[0] * False	Enters the fixed value of FALSE in the logic rule.
[1] True	Enters the fixed value TRUE in the logic rule.
[2] Running	See parameter group 5-3* for further description.
[3] In range	See parameter group 5-3* for further description.
[4] On reference	See parameter group 5-3* for further description.
[5] Torque limit	See parameter group 5-3* for further description.
[6] Current limit	See parameter group 5-3* for further description.
[7] Out of current range	See parameter group 5-3* for further description.
[8] Below I low	See parameter group 5-3* for further description.

[9]	Above I high	See parameter group 5-3* for further description.
[10]	Out of speed range	
[11]	Below speed low	See parameter group 5-3* for further description.
[12]	Above speed high	See parameter group 5-3* for further description.
[13]	Out of feedb. range	
[14]	Below feedb. low	
[15]	Above feedb. high	
[16]	Thermal warning	See parameter group 5-3* for further description.
[17]	Mains out of range	See parameter group 5-3* for further description.
[18]	Reversing	See parameter group 5-3* for further description.
[19]	Warning	See parameter group 5-3* for further description.
[20]	Alarm (trip)	See parameter group 5-3* for further description.
[21]	Alarm (trip lock)	See parameter group 5-3* for further description.
[22]	Comparator 0	Use the result of comparator 0 in the logic rule.
[23]	Comparator 1	Use the result of comparator 1 in the logic rule.
[24]	Comparator 2	Use the result of comparator 2 in the logic rule.
[25]	Comparator 3	Use the result of comparator 3 in the logic rule.
[26]	Logic rule 0	Use the result of logic rule 0 in the logic rule.
[27]	Logic rule 1	Use the result of logic rule 1 in the logic rule.
[28]	Logic rule 2	Use the result of logic rule 2 in the logic rule.
[29]	Logic rule 3	Use the result of logic rule 3 in the logic rule.
[33]	Digital input DI18	Use the value of DI18 in the logic rule (High = TRUE).
[34]	Digital input DI19	Use the value of DI19 in the logic rule (High = TRUE).
[35]	Digital input DI27	Use the value of DI27 in the logic rule (High = TRUE).
[36]	Digital input DI29	Use the value of DI29 in the logic rule (High = TRUE).
[37]	Digital input DI32	Use the value of DI32 in the logic rule (High = TRUE).
[38]	Digital input DI33	Use the value of DI33 in the logic rule (High = TRUE).
[39]	Start command	This event is TRUE if the frequency converter is started by any means (either via digital input, field bus or other).
[40]	Drive stopped	This event is TRUE if the frequency converter is stopped or coasted by any means (either via digital input, fieldbus or other).
[41]	Reset Trip	This event is TRUE if the frequency converter is tripped (but not trip-locked) and the reset button is pressed.
[42]	Auto Reset Trip	This event is TRUE if the frequency converter is tripped (but not trip-locked) and an Automatic Reset is issued.
[43]	OK Key	This event is TRUE if the OK key on the LCP is pressed.
[44]	Reset Key	This event is TRUE if the Reset key on the LCP is pressed.
[45]	Left Key	This event is TRUE if the Left key on the LCP is pressed.
[46]	Right Key	This event is TRUE if the Right key on the LCP is pressed.
[47]	Up Key	This event is TRUE if the Up key on the LCP is pressed.

[48]	Down Key	This event is TRUE if the Down key on the LCP is pressed.
[50]	Comparator 4	Use the result of comparator 4 in the logic rule.
[51]	Comparator 5	Use the result of comparator 5 in the logic rule.
[60]	Logic rule 4	Use the result of logic rule 4 in the logic rule.
[61]	Logic rule 5	Use the result of logic rule 5 in the logic rule.

13-02 Stop Event

Option:

Function:

Select the boolean (TRUE or FALSE) input to deactivate Smart Logic Control.

[0] *	False	Enters the fixed value of FALSE in the logic rule.
[1]	True	Enters the fixed value TRUE in the logic rule.
[2]	Running	See parameter group 5-3* for further description.
[3]	In range	See parameter group 5-3* for further description.
[4]	On reference	See parameter group 5-3* for further description.
[5]	Torque limit	See parameter group 5-3* for further description.
[6]	Current limit	See parameter group 5-3* for further description.
[7]	Out of current range	See parameter group 5-3* for further description.
[8]	Below I low	See parameter group 5-3* for further description.
[9]	Above I high	See parameter group 5-3* for further description.
[10]	Out of speed range	
[11]	Below speed low	See parameter group 5-3* for further description.
[12]	Above speed high	See parameter group 5-3* for further description.
[13]	Out of feedb. range	See parameter group 5-3* for further description.
[14]	Below feedb. low	See parameter group 5-3* for further description.
[15]	Above feedb. high	See parameter group 5-3* for further description.
[16]	Thermal warning	See parameter group 5-3* for further description.
[17]	Mains out of range	See parameter group 5-3* for further description.
[18]	Reversing	See parameter group 5-3* for further description.
[19]	Warning	See parameter group 5-3* for further description.
[20]	Alarm (trip)	See parameter group 5-3* for further description.
[21]	Alarm (trip lock)	See parameter group 5-3* for further description.
[22]	Comparator 0	Use the result of comparator 0 in the logic rule.
[23]	Comparator 1	Use the result of comparator 1 in the logic rule.
[24]	Comparator 2	Use the result of comparator 2 in the logic rule.
[25]	Comparator 3	Use the result of comparator 3 in the logic rule.
[26]	Logic rule 0	Use the result of logic rule 0 in the logic rule.
[27]	Logic rule 1	Use the result of logic rule 1 in the logic rule.
[28]	Logic rule 2	Use the result of logic rule 2 in the logic rule.
[29]	Logic rule 3	Use the result of logic rule 3 in the logic rule.

[30]	SL Time-out 0	Use the result of timer 0 in the logic rule.
[31]	SL Time-out 1	Use the result of timer 1 in the logic rule.
[32]	SL Time-out 2	Use the result of timer 2 in the logic rule.
[33]	Digital input DI18	Use the value of DI18 in the logic rule (High = TRUE).
[34]	Digital input DI19	Use the value of DI19 in the logic rule (High = TRUE).
[35]	Digital input DI27	Use the value of DI27 in the logic rule (High = TRUE).
[36]	Digital input DI29	Use the value of DI29 in the logic rule (High = TRUE).
[37]	Digital input DI32	Use the value of DI32 in the logic rule (High = TRUE).
[38]	Digital input DI33	Use the value of DI33 in the logic rule (High = TRUE).
[39]	Start command	This event is TRUE if the frequency converter is started by any means (either via digital input, field bus or other).
[40]	Drive stopped	This event is TRUE if the frequency converter is stopped or coasted by any means (either via digital input, fieldbus or other).
[41]	Reset Trip	This event is TRUE if the frequency converter is tripped (but not trip-locked) and the reset button is pressed.
[42]	Auto Reset Trip	This event is TRUE if the frequency converter is tripped (but not trip-locked) and an Automatic Reset is issued.
[43]	OK Key	This event is TRUE if the OK key on the LCP is pressed.
[44]	Reset Key	This event is TRUE if the Reset key on the LCP is pressed.
[45]	Left Key	This event is TRUE if the Left key on the LCP is pressed.
[46]	Right Key	This event is TRUE if the Right key on the LCP is pressed.
[47]	Up Key	This event is TRUE if the Up key on the LCP is pressed.
[48]	Down Key	This event is TRUE if the Down key on the LCP is pressed.
[50]	Comparator 4	Use the result of comparator 4 in the logic rule.
[51]	Comparator 5	Use the result of comparator 5 in the logic rule.
[60]	Logic rule 4	Use the result of logic rule 4 in the logic rule.
[61]	Logic rule 5	Use the result of logic rule 5 in the logic rule.
[70]	SL Time-out 3	Use the result of timer 3 in the logic rule.
[71]	SL Time-out 4	Use the result of timer 4 in the logic rule.
[72]	SL Time-out 5	Use the result of timer 5 in the logic rule.
[73]	SL Time-out 6	Use the result of timer 6 in the logic rule.
[74]	SL Time-out 7	Use the result of timer 7 in the logic rule.
[80]	No Flow	
[81]	Dry Pump	
[82]	End of Curve	
[83]	Broken Belt	

13-03 Reset SLC

Option:

Function:

[0] *	Do not reset SLC	Retains programmed settings in all group 13 parameters (13-*).
[1]	Reset SLC	Resets all group 13 parameters (13-*) to default settings.

3.13.3 13-1* Comparators

Comparators are used for comparing continuous variables (i.e. output frequency, output current, analog input etc.) to fixed preset values. In addition, there are digital values that will be compared to fixed time values. See explanation in par. 13-10 *Comparator Operand*. Comparators are evaluated once in each scan interval. Use the result (TRUE or FALSE) directly. All parameters in this parameter group are array parameters with index 0 to 5. Select index 0 to programme Comparator 0, select index 1 to programme Comparator 1, and so on.

13-10 Comparator Operand

Array [4]

Option:

Function:

Select the variable to be monitored by the comparator.

[0] *	DISABLED
[1]	Reference
[2]	Feedback
[3]	Motor speed
[4]	Motor current
[5]	Motor torque
[6]	Motor power
[7]	Motor voltage
[8]	DC-link voltage
[9]	Motor thermal
[10]	Drive thermal
[11]	Heat sink temp.
[12]	Analog input AI53
[13]	Analog input AI54
[14]	Analog input AIFB10
[15]	Analog input AIS24V
[17]	Analog input AICCT
[18]	Pulse input FI29
[19]	Pulse input FI33
[20]	Alarm number
[30]	Counter A
[31]	Counter B

13-11 Comparator Operator

Array [6]

Option:

Function:

[0] *	<	Select < [0] for the result of the evaluation to be TRUE, when the variable selected in par. 13-10 <i>Comparator Operand</i> is smaller than the fixed value in par. 13-12 <i>Comparator Value</i> . The result will be FALSE, if the variable selected in par. 13-10 <i>Comparator Operand</i> is greater than the fixed value in par. 13-12 <i>Comparator Value</i> .
[1]	≈ (equal)	Select ≈ [1] for the result of the evaluation to be TRUE, when the variable selected in par. 13-10 <i>Comparator Operand</i> is approximately equal to the fixed value in par. 13-12 <i>Comparator Value</i> .
[2]	>	Select > [2] for the inverse logic of option < [0].

13-12 Comparator Value

Array [6]

Range:

0 N/A* [-100000.000 - 100000.000 N/A]

Function:

Enter the 'trigger level' for the variable that is monitored by this comparator. This is an array parameter containing comparator values 0 to 5.

3

3.13.4 13-2* Timers

This parameter group consists of timer parameters.

Use the result (TRUE or FALSE) from *timers* directly to define an *event* (see par. 13-51 *SL Controller Event*), or as boolean input in a *logic rule* (see par. 13-40 *Logic Rule Boolean 1*, par. 13-42 *Logic Rule Boolean 2* or par. 13-44 *Logic Rule Boolean 3*). A timer is only FALSE when started by an action (i.e. Start timer 1 [29]) until the timer value entered in this parameter is elapsed. Then it becomes TRUE again.

All parameters in this parameter group are array parameters with index 0 to 2. Select index 0 to program Timer 0, select index 1 to program Timer 1, and so on.

13-20 SL Controller Timer

Array [3]

Range:

0 N/A* [0.000 - 360000.000 N/A]

Function:

Enter the value to define the duration of the FALSE output from the programmed timer. A timer is only FALSE if it is started by an action (i.e. *Start timer 1* [29]) and until the given timer value has elapsed.

3.13.5 13-4* Logic Rules

Combine up to three boolean inputs (TRUE / FALSE inputs) from timers, comparators, digital inputs, status bits and events using the logical operators AND, OR, and NOT. Select boolean inputs for the calculation in par. 13-40 *Logic Rule Boolean 1*, par. 13-42 *Logic Rule Boolean 2* and par. 13-44 *Logic Rule Boolean 3*. Define the operators used to logically combine the selected inputs in par. 13-41 *Logic Rule Operator 1* and par. 13-43 *Logic Rule Operator 2*.

Priority of calculation

The results of par. 13-40 *Logic Rule Boolean 1*, par. 13-41 *Logic Rule Operator 1* and par. 13-42 *Logic Rule Boolean 2* are calculated first. The outcome (TRUE / FALSE) of this calculation is combined with the settings of par. 13-43 *Logic Rule Operator 2* and par. 13-44 *Logic Rule Boolean 3*, yielding the final result (TRUE / FALSE) of the logic rule.

13-40 Logic Rule Boolean 1

Array [6]

Option:**Function:**

[0] *	False	Enters the fixed value of FALSE in the logic rule.
[1]	True	Enters the fixed value TRUE in the logic rule.
[2]	Running	See parameter group 5-3* for further description.
[3]	In range	See parameter group 5-3* for further description.
[4]	On reference	See parameter group 5-3* for further description.
[5]	Torque limit	See parameter group 5-3* for further description.
[6]	Current limit	See parameter group 5-3* for further description.
[7]	Out of current range	See parameter group 5-3* for further description.
[8]	Below I low	See parameter group 5-3* for further description.
[9]	Above I high	See parameter group 5-3* for further description.
[10]	Out of speed range	
[11]	Below speed low	See parameter group 5-3* for further description.
[12]	Above speed high	See parameter group 5-3* for further description.
[13]	Out of feedb. range	See parameter group 5-3* for further description.
[14]	Below feedb. low	See parameter group 5-3* for further description.
[15]	Above feedb. high	See parameter group 5-3* for further description.
[16]	Thermal warning	See parameter group 5-3* for further description.
[17]	Mains out of range	See parameter group 5-3* for further description.
[18]	Reversing	See parameter group 5-3* for further description.
[19]	Warning	See parameter group 5-3* for further description.
[20]	Alarm (trip)	See parameter group 5-3* for further description.
[21]	Alarm (trip lock)	See parameter group 5-3* for further description.
[22]	Comparator 0	Use the result of comparator 0 in the logic rule.
[23]	Comparator 1	Use the result of comparator 1 in the logic rule.
[24]	Comparator 2	Use the result of comparator 2 in the logic rule.
[25]	Comparator 3	Use the result of comparator 3 in the logic rule.
[26]	Logic rule 0	Use the result of logic rule 0 in the logic rule.
[27]	Logic rule 1	Use the result of logic rule 1 in the logic rule.
[28]	Logic rule 2	Use the result of logic rule 2 in the logic rule.
[29]	Logic rule 3	Use the result of logic rule 3 in the logic rule.
[30]	SL Time-out 0	Use the result of timer 0 in the logic rule.
[31]	SL Time-out 1	Use the result of timer 1 in the logic rule.
[32]	SL Time-out 2	Use the result of timer 2 in the logic rule.
[33]	Digital input DI18	Use the value of DI18 in the logic rule (High = TRUE).
[34]	Digital input DI19	Use the value of DI19 in the logic rule (High = TRUE).
[35]	Digital input DI27	Use the value of DI27 in the logic rule (High = TRUE).

[36]	Digital input DI29	Use the value of DI29 in the logic rule (High = TRUE).
[37]	Digital input DI32	Use the value of DI32 in the logic rule (High = TRUE).
[38]	Digital input DI33	Use the value of DI33 in the logic rule (High = TRUE).
[39]	Start command	This logic rule is TRUE if the frequency converter is started by any means (either via digital input, field bus or other).
[40]	Drive stopped	This logic rule is TRUE if the frequency converter is stopped or coasted by any means (either via digital input, fieldbus or other).
[41]	Reset Trip	This logic rule is TRUE if the frequency converter is tripped (but not trip-locked) and the reset button is pressed.
[42]	Auto Reset Trip	This logic rule is TRUE if the frequency converter is tripped (but not trip-locked) and an Automatic Reset is issued.
[43]	OK Key	This logic rule is TRUE if the OK key on the LCP is pressed.
[44]	Reset Key	This logic rule is TRUE if the Reset key on the LCP is pressed.
[45]	Left Key	This logic rule is TRUE if the Left key on the LCP is pressed.
[46]	Right Key	This logic rule is TRUE if the Right key on the LCP is pressed.
[47]	Up Key	This logic rule is TRUE if the Up key on the LCP is pressed.
[48]	Down Key	This logic rule is TRUE if the Down key on the LCP is pressed.
[50]	Comparator 4	Use the result of comparator 4 in the logic rule.
[51]	Comparator 5	Use the result of comparator 5 in the logic rule.
[60]	Logic rule 4	Use the result of logic rule 4 in the logic rule.
[61]	Logic rule 5	Use the result of logic rule 5 in the logic rule.
[70]	SL Time-out 3	Use the result of timer 3 in the logic rule.
[71]	SL Time-out 4	Use the result of timer 4 in the logic rule.
[72]	SL Time-out 5	Use the result of timer 5 in the logic rule.
[73]	SL Time-out 6	Use the result of timer 6 in the logic rule.
[74]	SL Time-out 7	Use the result of timer 7 in the logic rule.
[80]	No Flow	
[81]	Dry Pump	
[82]	End of Curve	
[83]	Broken Belt	

13-41 Logic Rule Operator 1

Array [6]

Option:**Function:**

Select the first logical operator to use on the Boolean inputs from par. 13-40 *Logic Rule Boolean 1* and par. 13-42 *Logic Rule Boolean 2*.
[13 -XX] signifies the boolean input of par. 13-*.

[0] *	DISABLED	Ignores par. , par. 13-43 <i>Logic Rule Operator 2</i> , and par. 13-44 <i>Logic Rule Boolean 3</i> .
[1]	AND	evaluates the expression [13-40] AND [13-42].
[2]	OR	evaluates the expression [13-40] OR [13-42].
[3]	AND NOT	evaluates the expression [13-40] AND NOT [13-42].
[4]	OR NOT	evaluates the expression [13-40] OR NOT [13-42].
[5]	NOT AND	evaluates the expression NOT [13-40] AND [13-42].
[6]	NOT OR	evaluates the expression NOT [13-40] OR [13-42].
[7]	NOT AND NOT	evaluates the expression NOT [13-40] AND NOT [13-42].
[8]	NOT OR NOT	evaluates the expression NOT [13-40] OR NOT [13-42].

13-42 Logic Rule Boolean 2

Array [6]

Option:**Function:**

Select the second boolean (TRUE or FALSE) input for the selected logic rule.
See par. 13-40 *Logic Rule Boolean 1* for further descriptions of choices and their functions.

[0] *	False
[1]	True
[2]	Running
[3]	In range
[4]	On reference
[5]	Torque limit
[6]	Current limit
[7]	Out of current range
[8]	Below I low
[9]	Above I high
[10]	Out of speed range
[11]	Below speed low
[12]	Above speed high
[13]	Out of feedb. range
[14]	Below feedb. low
[15]	Above feedb. high
[16]	Thermal warning
[17]	Mains out of range
[18]	Reversing
[19]	Warning
[20]	Alarm (trip)
[21]	Alarm (trip lock)
[22]	Comparator 0
[23]	Comparator 1

[24]	Comparator 2
[25]	Comparator 3
[26]	Logic rule 0
[27]	Logic rule 1
[28]	Logic rule 2
[29]	Logic rule 3
[30]	SL Time-out 0
[31]	SL Time-out 1
[32]	SL Time-out 2
[33]	Digital input DI18
[34]	Digital input DI19
[35]	Digital input DI27
[36]	Digital input DI29
[37]	Digital input DI32
[38]	Digital input DI33
[39]	Start command
[40]	Drive stopped
[41]	Reset Trip
[42]	Auto Reset Trip
[43]	OK Key
[44]	Reset Key
[45]	Left Key
[46]	Right Key
[47]	Up Key
[48]	Down Key
[50]	Comparator 4
[51]	Comparator 5
[60]	Logic rule 4
[61]	Logic rule 5
[70]	SL Time-out 3
[71]	SL Time-out 4
[72]	SL Time-out 5
[73]	SL Time-out 6
[74]	SL Time-out 7
[80]	No Flow
[81]	Dry Pump
[82]	End of Curve
[83]	Broken Belt

13-43 Logic Rule Operator 2

Array [6]

Option:**Function:**

Select the second logical operator to be used on the boolean input calculated in par. 13-40 *Logic Rule Boolean 1*, par. 13-41 *Logic Rule Operator 1*, and par. 13-42 *Logic Rule Boolean 2*, and the boolean input coming from par. 13-42 *Logic Rule Boolean 2*.

[13-44] signifies the boolean input of par. 13-44 *Logic Rule Boolean 3*.

[13-40/13-42] signifies the boolean input calculated in par. 13-40 *Logic Rule Boolean 1*, par. 13-41 *Logic Rule Operator 1*, and par. 13-42 *Logic Rule Boolean 2*. DISABLED [0] (factory setting). select this option to ignore par. 13-44 *Logic Rule Boolean 3*.

[0] * DISABLED

[1] AND

[2] OR

[3] AND NOT

[4] OR NOT

[5] NOT AND

[6] NOT OR

[7] NOT AND NOT

[8] NOT OR NOT

13-44 Logic Rule Boolean 3

Array [6]

Option:**Function:**

Select the third boolean (TRUE or FALSE) input for the selected logic rule.

See par. 13-40 *Logic Rule Boolean 1* for further descriptions of choices and their functions.

[0] * False

[1] True

[2] Running

[3] In range

[4] On reference

[5] Torque limit

[6] Current limit

[7] Out of current range

[8] Below I low

[9] Above I high

[10] Out of speed range

[11] Below speed low

[12] Above speed high

[13] Out of feedb. range

[14] Below feedb. low

[15] Above feedb. high

[16] Thermal warning

[17] Mains out of range

[18] Reversing

[19] Warning

[20] Alarm (trip)

[21] Alarm (trip lock)

[22] Comparator 0

[23]	Comparator 1
[24]	Comparator 2
[25]	Comparator 3
[26]	Logic rule 0
[27]	Logic rule 1
[28]	Logic rule 2
[29]	Logic rule 3
[30]	SL Time-out 0
[31]	SL Time-out 1
[32]	SL Time-out 2
[33]	Digital input DI18
[34]	Digital input DI19
[35]	Digital input DI27
[36]	Digital input DI29
[37]	Digital input DI32
[38]	Digital input DI33
[39]	Start command
[40]	Drive stopped
[41]	Reset Trip
[42]	Auto Reset Trip
[43]	OK Key
[44]	Reset Key
[45]	Left Key
[46]	Right Key
[47]	Up Key
[48]	Down Key
[50]	Comparator 4
[51]	Comparator 5
[60]	Logic rule 4
[61]	Logic rule 5
[70]	SL Time-out 3
[71]	SL Time-out 4
[72]	SL Time-out 5
[73]	SL Time-out 6
[74]	SL Time-out 7
[80]	No Flow
[81]	Dry Pump
[82]	End of Curve
[83]	Broken Belt

3.13.6 13-5* States

Parameters for programming the Smart Logic Controller.

13-51 SL Controller Event

Array [20]

Option:

Function:

Select the boolean input (TRUE or FALSE) to define the Smart Logic Controller event.
See par. 13-02 *Stop Event* for further descriptions of choices and their functions.

[0] * False

[1] True

[2] Running

[3] In range

[4] On reference

[5] Torque limit

[6] Current limit

[7] Out of current range

[8] Below I low

[9] Above I high

[10] Out of speed range

[11] Below speed low

[12] Above speed high

[13] Out of feedb. range

[14] Below feedb. low

[15] Above feedb. high

[16] Thermal warning

[17] Mains out of range

[18] Reversing

[19] Warning

[20] Alarm (trip)

[21] Alarm (trip lock)

[22] Comparator 0

[23] Comparator 1

[24] Comparator 2

[25] Comparator 3

[26] Logic rule 0

[27] Logic rule 1

[28] Logic rule 2

[29] Logic rule 3

[30] SL Time-out 0

[31] SL Time-out 1

[32] SL Time-out 2

[33] Digital input DI18

[34] Digital input DI19

[35] Digital input DI27

[36] Digital input DI29

[37] Digital input DI32

[38] Digital input DI33

[39] Start command

[40] Drive stopped

[41] Reset Trip

[42] Auto Reset Trip

[43] OK Key

[44]	Reset Key
[45]	Left Key
[46]	Right Key
[47]	Up Key
[48]	Down Key
[50]	Comparator 4
[51]	Comparator 5
[60]	Logic rule 4
[61]	Logic rule 5
[70]	SL Time-out 3
[71]	SL Time-out 4
[72]	SL Time-out 5
[73]	SL Time-out 6
[74]	SL Time-out 7
[80]	No Flow
[81]	Dry Pump
[82]	End of Curve
[83]	Broken Belt

13-52 SL Controller Action

Array [20]

Option:

Function:

Select the action corresponding to the SLC event. Actions are executed when the corresponding event (defined in par. 13-51 *SL Controller Event*) is evaluated as true. The following actions are available for selection:

[0] *	Disabled	
[1]	No action	
[2]	Select set-up 1	Changes the active set-up (par. 0-10 <i>Active Set-up</i>) to '1'.
[3]	Select set-up 2	Changes the active set-up (par. 0-10 <i>Active Set-up</i>) to '2'.
[4]	Select set-up 3	Changes the active set-up (par. 0-10 <i>Active Set-up</i>) to '3'.
[5]	Select set-up 4	Changes the active set-up (par. 0-10 <i>Active Set-up</i>) to '4'. If the set-up is changed, it will merge with other set-up commands coming from either the digital inputs or via a fieldbus.
[10]	Select preset ref 0	Selects preset reference 0.
[11]	Select preset ref 1	Selects preset reference 1.
[12]	Select preset ref 2	Selects preset reference 2.
[13]	Select preset ref 3	Selects preset reference 3.
[14]	Select preset ref 4	Selects preset reference 4.
[15]	Select preset ref 5	Selects preset reference 5.
[16]	Select preset ref 6	Selects preset reference 6.
[17]	Select preset ref 7	Selects preset reference 7. If the active preset reference is changed, it will merge with other preset reference commands coming from either the digital inputs or via a fieldbus.
[18]	Select ramp 1	Selects ramp 1
[19]	Select ramp 2	Selects ramp 2
[22]	Run	Issues a start command to the frequency converter.

[23]	Run reverse	Issues a start reverse command to the frequency converter.
[24]	Stop	Issues a stop command to the frequency converter.
[26]	DC Brake	Issues a DC stop command to the frequency converter.
[27]	Coast	The frequency converter coasts immediately. All stop commands including the coast command stop the SLC.
[28]	Freeze output	Freezes the output frequency of the frequency converter.
[29]	Start timer 0	Starts timer 0, see par. 13-20 <i>SL Controller Timer</i> for further description.
[30]	Start timer 1	Starts timer 1, see par. 13-20 <i>SL Controller Timer</i> for further description.
[31]	Start timer 2	Starts timer 2, see par. 13-20 <i>SL Controller Timer</i> for further description.
[32]	Set digital out A low	Any output with 'digital output 1' selected is low (off).
[33]	Set digital out B low	Any output with 'digital output 2' selected is low (off).
[34]	Set digital out C low	Any output with 'digital output 3' selected is low (off).
[35]	Set digital out D low	Any output with 'digital output 4' selected is low (off).
[36]	Set digital out E low	Any output with 'digital output 5' selected is low (off).
[37]	Set digital out F low	Any output with 'digital output 6' selected is low (off).
[38]	Set digital out A high	Any output with 'digital output 1' selected is high (closed).
[39]	Set digital out B high	Any output with 'digital output 2' selected is high (closed).
[40]	Set digital out C high	Any output with 'digital output 3' selected is high (closed).
[41]	Set digital out D high	Any output with 'digital output 4' selected is high (closed).
[42]	Set digital out E high	Any output with 'digital output 5' selected is high (closed).
[43]	Set digital out F high	Any output with 'digital output 6' selected is high (closed).
[60]	Reset Counter A	Resets Counter A to zero.
[61]	Reset Counter B	Resets Counter A to zero.
[70]	Start Timer 3	Starts timer 3, see par. 13-20 <i>SL Controller Timer</i> for further description.
[71]	Start Timer 4	Starts timer 4, see par. 13-20 <i>SL Controller Timer</i> for further description.
[72]	Start Timer 5	Starts timer 5, see par. 13-20 <i>SL Controller Timer</i> for further description.
[73]	Start Timer 6	Starts timer 6, see par. 13-20 <i>SL Controller Timer</i> for further description.
[74]	Start Timer 7	Starts timer 7, see par. 13-20 <i>SL Controller Timer</i> for further description.
[80]	Sleep Mode	

3.14 Main Menu - Special Functions -Group 14

3.14.1 14-** Special Functions

Parameter group for configuring special frequency converter functions.

3.14.2 Inverter Switching 14-0*

Parameters for configuring the inverter switching.

14-00 Switching Pattern

Option:
Function:

Select the switching pattern: 60° AVM or SFAVM.

[0] * 60 AVM

[1] SFAVM

14-01 Switching Frequency

Option:
Function:

Select the inverter switching frequency. Changing the switching frequency can help to reduce acoustic noise from the motor.

NB!

The output frequency value of the frequency converter must never exceed 1/10 of the switching frequency. When the motor is running, adjust the switching frequency in par. 14-01 *Switching Frequency* until the motor is as noiseless as possible. See also par. 14-00 *Switching Pattern* and the section *Derating*.

[0] 1.0 kHz

[1] 1.5 kHz

[2] 2.0 kHz

[3] 2.5 kHz

[4] 3.0 kHz

[5] 3.5 kHz

[6] 4.0 kHz

[7] * 5.0 kHz

[8] 6.0 kHz

[9] 7.0 kHz

[10] 8.0 kHz

[11] 10.0 kHz

[12] 12.0 kHz

[13] 14.0 kHz

[14] 16.0 kHz

14-03 Overmodulation

Option:
Function:

[0] Off

Selects no over-modulation of the output voltage in order to avoid torque ripple on the motor shaft.

[1] * On

The over-modulation function generates an extra voltage of up-to 8% of U_{max} output voltage without over-modulation, which results in an extra torque of 10-12% in the middle of the over-synchronous range (from 0% at nominal speed rising to approximately 12% at double nominal speed).

14-04 PWM Random

Option:
Function:

[0] * Off

No change of the acoustic motor switching noise.

[1] On

Transforms the acoustic motor switching noise from a clear ringing tone to a less noticeable 'white' noise. This is achieved by slightly and randomly altering the synchronism of the pulse width modulated output phases.

3.14.3 Mains On/Off, 14-1 *

Parameters for configuring mains failure monitoring and handling.

14-10 Mains Failure

Option:

Function:

		Select the function at which the frequency converter must act, when the threshold set in par. 14-11 <i>Mains Voltage at Mains Fault</i> has been reached or a <i>Mains Failure Inverse</i> command is activated via one of the digital inputs (par. 5-1*).
[0] *	No function	The energy left in the capacitor bank will be used to "drive" the motor, but will be discharged.
[1]	Ctrl. ramp-down	The frequency converter will perform a controlled ramp-down. par. 2-10 <i>Brake Function</i> must be set to <i>Off</i> [0].
[3]	Coasting	The inverter will turn off and the capacitor bank will back up the control card then ensuring a faster restart when mains reconnected (at short power zags).
[4]	Kinetic back-up	The frequency converter will ride through by controlling speed for generative operation of the motor utilizing the moment of inertia of the system as long as sufficient energy is present.



NB!

For best performance of controlled ramp-down and kinetic back-up par. 1-03 *Torque Characteristics* should be set to *Compressor* [0] or *Variable Torque* [1] (no automatic energy optimization should be active).

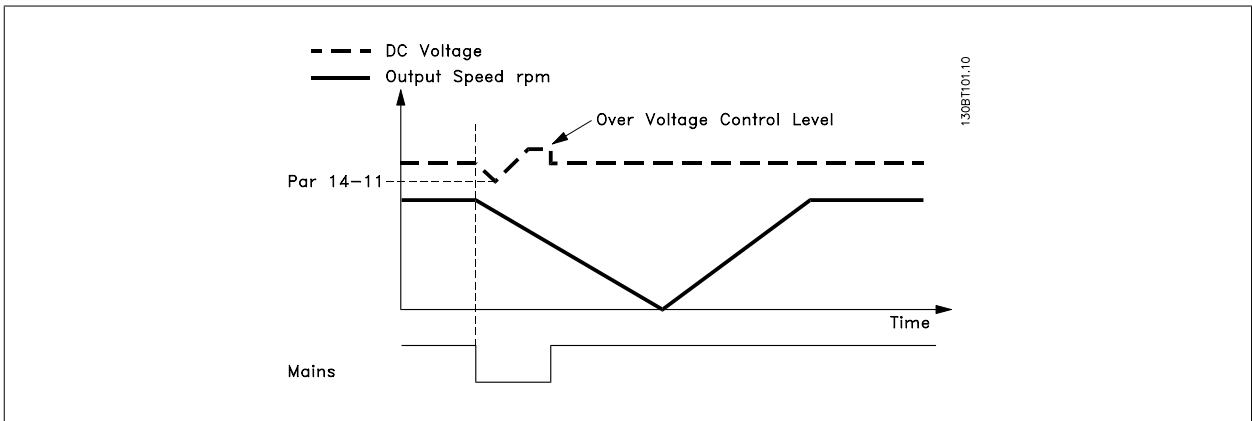

Illustration 3.2: Controlled Ramp-down - short mains failure. Ramping down to stop followed by ramping up to reference.

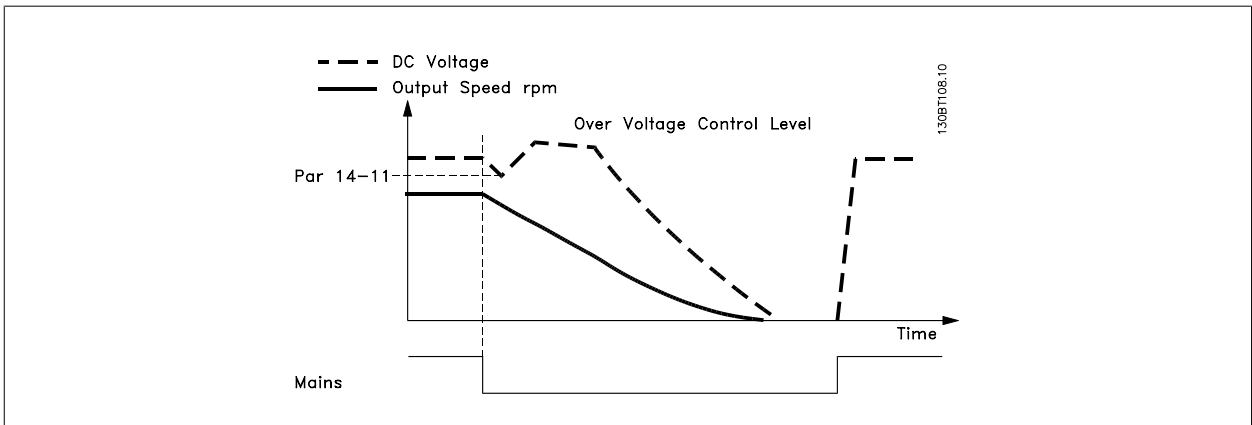

Illustration 3.3: Controlled Ramp-down, longer mains failure. Ramping down as long as the energy in the system allows for it, then the motor is coasted.

3

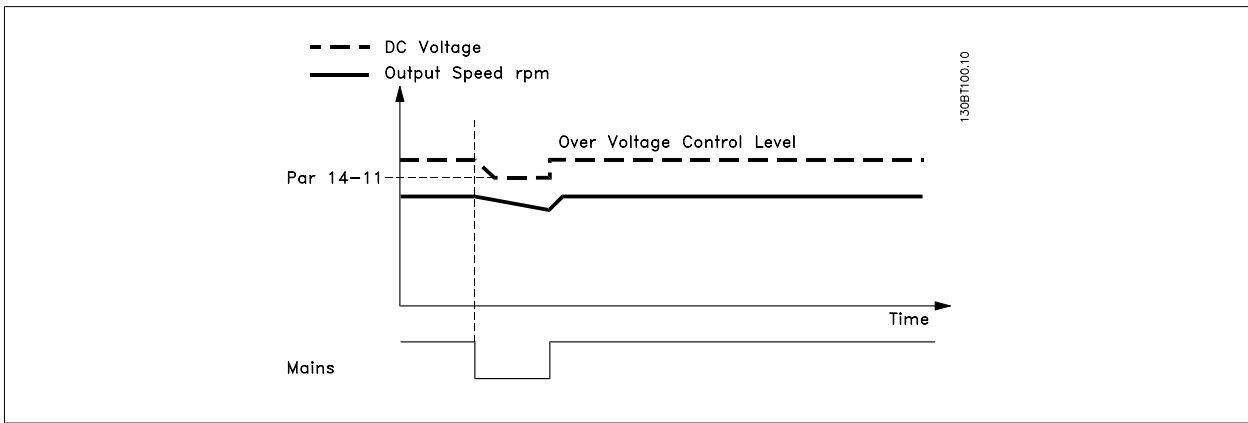

Illustration 3.4: Kinetic Back-up, short mains failure. Ride through as long as the energy in the system allows for it.

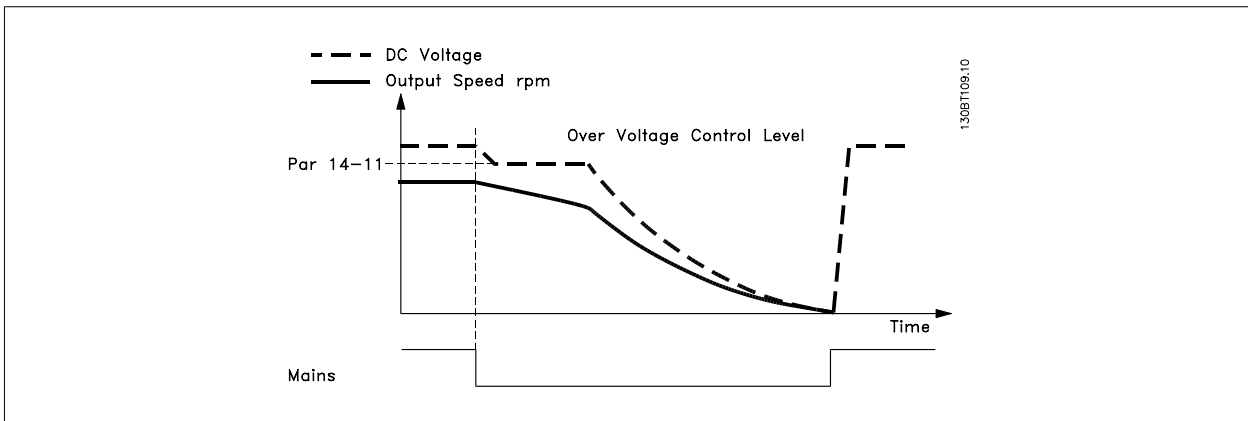

Illustration 3.5: Kinetic Back-up, longer mains failure. The motor is coasted as soon as the energy in the system is too low.

14-11 Mains Voltage at Mains Fault

Range:	Function:
342. V* [180 - 600 V]	This parameter defines the threshold voltage at which the selected function in par. 14-10 <i>Mains Failure</i> should be activated.

14-12 Function at Mains Imbalance

Option:	Function:
	Operation under severe main imbalance conditions reduces the lifetime of the motor. Conditions are considered severe if the motor is operated continuously near nominal load (e.g. a pump or fan running near full speed). When a severe mains imbalance is detected:
[0] * Trip	Select <i>Trip</i> [0] to trip the frequency converter.
[1] Warning	Select <i>Warning</i> [1] to issue a warning.
[2] Disabled	Select <i>Disabled</i> [2] for no action.
[3] Derate	Select <i>Derate</i> [3] for derating the frequency converter.

3.14.4 Trip Reset, 14-2*

Parameters for configuring auto reset handling, special trip handling and control card self test or initialisation.

14-20 Reset Mode

Option:	Function:
	Select the reset function after tripping. Once reset, the frequency converter can be restarted.
[0] * Manual reset	Select <i>Manual reset</i> [0], to perform a reset via [RESET] or via the digital inputs.
[1] Automatic reset x 1	Select <i>Automatic reset x 1...x20</i> [1]-[12] to perform between one and twenty automatic resets after tripping.
[2] Automatic reset x 2	
[3] Automatic reset x 3	
[4] Automatic reset x 4	
[5] Automatic reset x 5	
[6] Automatic reset x 6	
[7] Automatic reset x 7	
[8] Automatic reset x 8	
[9] Automatic reset x 9	
[10] Automatic reset x 10	
[11] Automatic reset x 15	
[12] Automatic reset x 20	
[13] Infinite auto reset	Select <i>Infinite Automatic Reset</i> [13] for continuous resetting after tripping.

 **NB!**
 The motor may start without warning. If the specified number of AUTOMATIC RESETs is reached within 10 minutes, the frequency converter enters Manual reset [0] mode. After the Manual reset is performed, the setting of par. 14-20 *Reset Mode* reverts to the original selection. If the number of automatic resets is not reached within 10 minutes, or when a Manual reset is performed, the internal AUTOMATIC RESET counter returns to zero.

 **NB!**
 Automatic reset will also be active for resetting safe stop function in firmware version < 4.3x.

 **NB!**
 The setting in par. 14-20 *Reset Mode* is disregarded in case of Fire Mode being active (see par. 24-0*, Fire Mode).

14-21 Automatic Restart Time

Range:	Function:
10 s* [0 - 600 s]	Enter the time interval from trip to start of the automatic reset function. This parameter is active when par. 14-20 <i>Reset Mode</i> is set to <i>Automatic reset</i> [1] - [13].

14-22 Operation Mode

Option:

Function:

Use this parameter to specify normal operation, to perform tests or to initialise all parameters except par. 15-03 *Power Up's*, par. 15-04 *Over Temp's* and par. 15-05 *Over Volt's*. This function is active only when the power is cycled (power off-power on) to the frequency converter.

[0] * Normal operation

Select *Normal operation* [0] for normal operation of the frequency converter with the motor in the selected application.

[1] Control card test

Select *Control card test* [1] to test the analog and digital inputs and outputs and the +10 V control voltage. The test requires a test connector with internal connections.

Use the following procedure for the control card test:

1. Select *Control card test* [1].
2. Disconnect the mains supply and wait for the light in the display to go out.
3. Set switches S201 (A53) and S202 (A54) = 'ON' / I.
4. Insert the test plug (see below).
5. Connect to mains supply.
6. Carry out various tests.
7. The results are displayed on the LCP and the frequency converter moves into an infinite loop.
8. par. 14-22 *Operation Mode* is automatically set to Normal operation. Carry out a power cycle to start up in Normal operation after a control card test.

If the test is OK:

LCP read-out: Control Card OK.

Disconnect the mains supply and remove the test plug. The green LED on the control card will light up.

If the test fails:

LCP read-out: Control Card I/O failure.

Replace the frequency converter or control card. The red LED on the control card is turned on. To test the plugs, connect/group the following terminals as shown below: (18 - 27 - 32), (19 - 29 - 33) and (42 - 53 - 54).

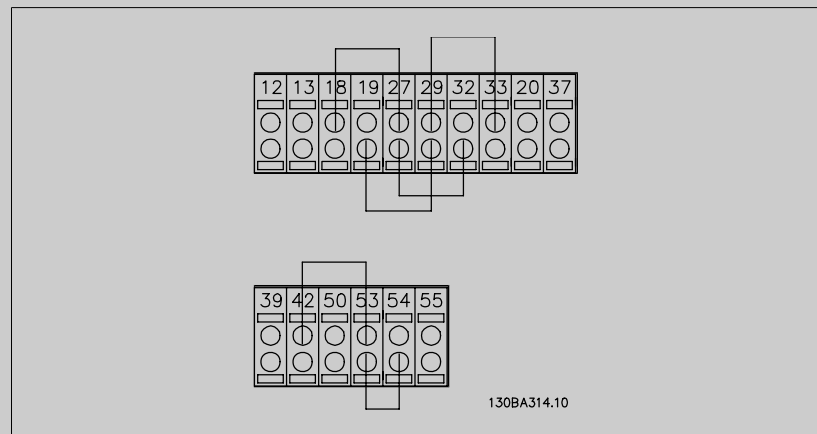

[2] Initialisation

Select *Initialization* [2] to reset all parameter values to default settings, except for par. 15-03 *Power Up's*, par. 15-04 *Over Temp's* and par. 15-05 *Over Volt's*. The frequency converter will reset during the next power-up.

par. 14-22 *Operation Mode* will also revert to the default setting *Normal operation* [0].

[3] Boot mode

14-25 Trip Delay at Torque Limit

Range:

60 s* [0 - 60 s]

Function:

Enter the torque limit trip delay in seconds. When the output torque reaches the torque limits (par. 4-16 *Torque Limit Motor Mode* and par. 4-17 *Torque Limit Generator Mode*), a warning is triggered. When the torque limit warning has been continuously present for the period specified in this parameter, the frequency converter trips. Disable the trip delay by setting the parameter to 60 s = OFF. Thermal frequency converter monitoring will still remain active.

14-26 Trip Delay at Inverter Fault

Range:

0. s* [0 - 35 s]

Function:

When the frequency converter detects an over-voltage in the set time trip will be effected after the set time.

14-29 Service Code

Range:

0 N/A* [-2147483647 - 2147483647 N/A]

Function:

Service use only.

3.14.5 Current Limit Control, 14-3*

The frequency converter features an integral Current Limit Controller which is activated when the motor current, and thus the torque, is higher than the torque limits set in par. 4-16 *Torque Limit Motor Mode* and par. 4-17 *Torque Limit Generator Mode*.

When the current limit is reached during motor operation or regenerative operation, the frequency converter will try to reduce torque below the preset torque limits as quickly as possible without losing control of the motor.

While the current control is active, the frequency converter can only be stopped by setting a digital input to *Coast inverse* [2] or *Coast and reset inv.* [3]. Any signal on terminals 18 to 33 will not be active until the frequency converter is no longer near the current limit.

By using a digital input set to *Coast inverse* [2] or *Coast and reset inv.* [3], the motor does not use the ramp-down time, since the frequency converter is coasted.

14-30 Current Lim Ctrl, Proportional Gain

Range:

100 %* [0 - 500 %]

Function:

Enter the proportional gain value for the current limit controller. Selection of a high value makes the controller react faster. Too high a setting leads to controller instability.

14-31 Current Lim Ctrl, Integration Time

Range:

0.020 s* [0.002 - 2.000 s]

Function:

Controls the current limit control integration time. Setting it to a lower value makes it react faster. A setting too low leads to control instability.

3.14.6 Energy Optimising, 14-4*

Parameters for adjusting the energy optimisation level in both Variable Torque (VT) and Automatic Energy Optimization (AEO) mode.

Automatic Energy Optimization is only active if par.1-03, Torque Characteristics, is set for either *Auto Energy Optim. Compressor* [2] or *Auto Energy Optim. VT* [3].

14-40 VT Level

Range:

66 %* [40 - 90 %]

Function:

Enter the level of motor magnetisation at low speed. Selection of a low value reduces energy loss in the motor, but also reduces load capability. This parameter cannot be adjusted while the motor is running.

14-41 AEO Minimum Magnetisation

Range:

40. %* [40 - 75 %]

Function:

Enter the minimum allowable magnetisation for AEO. Selection of a low value reduces energy loss in the motor, but can also reduce resistance to sudden load changes.

14-42 Minimum AEO Frequency

Range:

10 Hz* [5 - 40 Hz]

Function:

Enter the minimum frequency at which the Automatic Energy Optimisation (AEO) is to be active.

14-43 Motor Cosphi

Range:

0.66 N/A* [0.40 - 0.95 N/A]

Function:

The Cos(phi) setpoint is automatically set for optimum AEO performance during AMA. This parameter should normally not be altered. However in some situations it may be necessary to enter a new value to fine-tune.

3.14.7 Environment, 14-5*

These parameters help the frequency converter to operate under special environmental conditions.

14-50 RFI Filter

Option:

[0] Off

Function:

Select *Off*[0] only if the frequency converter is fed by an isolated mains source, i.e. from a special IT mains source.

In this mode, the internal RFI filter capacitors between chassis and the mains RFI filter circuit are cut-out to avoid damage of the intermediate circuit and to reduce the ground capacity currents according to IEC 61800-3.

[1]* On

Select *On*[1] to ensure that the frequency converter complies with EMC standards.

14-52 Fan Control

Option:

[0]* Auto

Function:

Select the minimum speed of the main fan.

Select *Auto*[0] to run the fan only when the internal temperature of the frequency converter is in the range +35 °C to approximately +55°C. The fan will run at low speed at +35C and at full speed at approximately +55°C.

[1] On 50%

[2] On 75%

[3] On 100%

14-53 Fan Monitor

Option:

[0] Disabled

Function:

Select which reaction the frequency converter should take in case a fan fault is detected.

[1]* Warning

[2] Trip

3.14.8 Auto Derate, 14-6*

This group contains parameters for derating the frequency converter in case of high temperature.

14-60 Function at Over Temperature

Option:

Function:

[0] * Trip

If either heatsink or control card temperature exceeds a factory-programmed temperature limit, a warning will be activated. If the temperature increases further, select whether the frequency converter should trip (trip locked) or derate the output current.

The frequency converter will trip (trip locked) and generate an alarm. Power must be cycled to reset the alarm, but will not allow restart of the motor until the heat sink temperature has dropped below the alarm limit.

[1] Derate

If the critical temperature is exceeded the output current will be reduced until the allowable temperature has been reached.



3.14.9 No Trip at Inverter Overload

In some pump systems, the frequency converter has not been sized properly to yield the current needed in all points of the operational flow-head characteristic. At these points, the pump will need a current higher than the rated current of the frequency converter. The frequency converter can yield 110% of the rated current continuously for 60 sec. If still overloaded, the frequency converter will normally trip (causing the pump to stop by coasting) and provide an alarm.

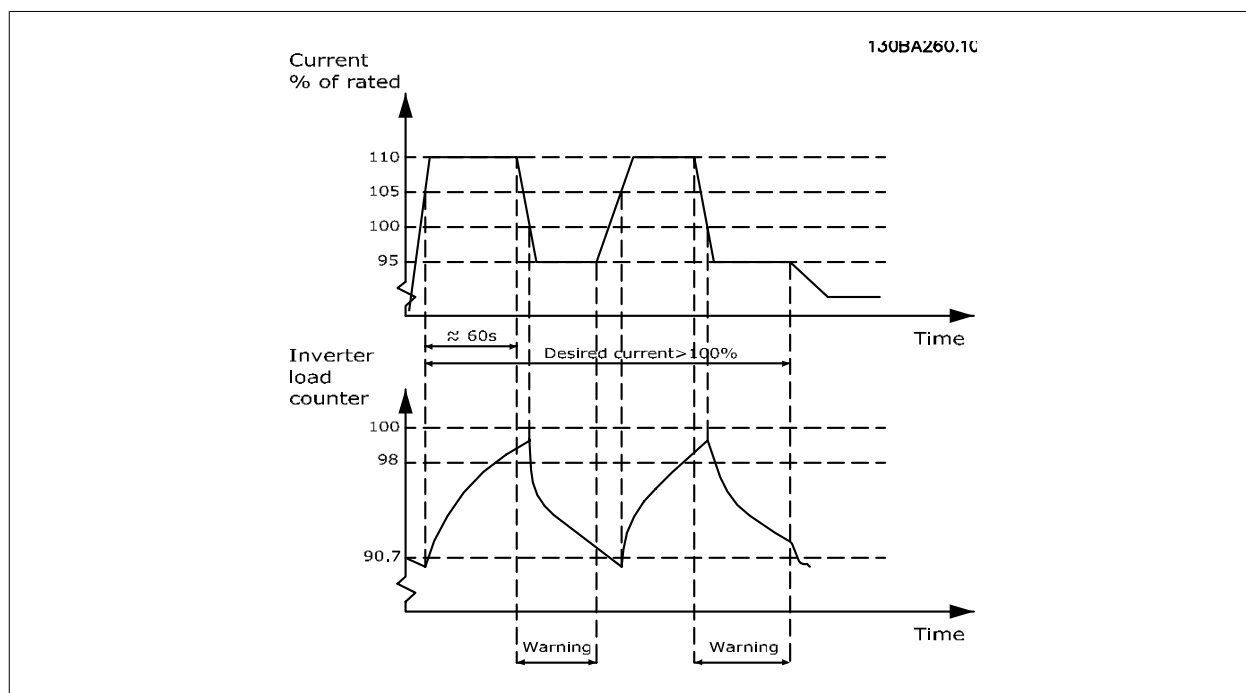

It may be preferable to run the pump at reduced speed for a while in case it is not possible to run continuously with demanded capacity.

Select *Function at Inverter Overload*, par. 14-61 *Function at Inverter Overload* to automatically reduce pump speed until the output current is below 100% of the rated current (set in par. 14-62 *Inv. Overload Derate Current*).

The *Function at Inverter Overload* is an alternative to letting the frequency converter trip.

The frequency converter estimates the load on the power section by means of an inverter load counter, which will cause a warning at 98% and a reset of the warning at 90%. At the value 100%, the frequency converter trips and provides an alarm.

Status for the counter can be read in par. 16-35 *Inverter Thermal*.

If par. 14-61 *Function at Inverter Overload* is set to Derate, the pump speed will be reduced when the counter exceeds 98, and stay reduced until the counter has dropped below 90.7.

If par. 14-62 *Inv. Overload Derate Current* is set e.g. to 95% a steady overload will cause the pump speed to fluctuate between values corresponding to 110% and 95% of rated output current for the frequency converter.

14-61 Function at Inverter Overload

Option:
Function:

		Is used in case of steady overload beyond the thermal limits (110% for 60 sec.).
[0] *	Trip	Choose Trip [0] to make the frequency converter trip and provide an alarm.
[1]	Derate	Derate [1] to reduce pump speed in order to decrease the load on the power section and allowing this to cool down.

14-62 Inv. Overload Derate Current

Range:
Function:

95 %*	[50 - 100 %]	Defines the desired current level (in % of rated output current for the frequency converter) when running with reduced pump speed after load on the frequency converter has exceeded the allowable limit (110% for 60 sec.).
-------	--------------	--

3.15 Main Menu - Frequency Converter Information - Group 15

3.15.1 15-** Drive Information

Parameter group containing frequency converter information such as operating data, hardware configuration and software versions.

3.15.2 15-0* Operating Data

Parameter group containing operating data e.g. Operating Hours, kWh counters, Power Ups, etc.

15-00 Operating Hours

Range:
Function:

0 h*	[0 - 2147483647 h]	View how many hours the frequency converter has run. The value is saved when the frequency converter is turned off.
------	--------------------	---

15-01 Running Hours

Range:
Function:

0 h*	[0 - 2147483647 h]	View how many hours the motor has run. Reset the counter in par. 15-07 <i>Reset Running Hours Counter</i> . The value is saved when the frequency converter is turned off.
------	--------------------	--

15-02 kWh Counter

Range:
Function:

0 kWh*	[0 - 2147483647 kWh]	Registering the power consumption of the motor as a mean value over one hour. Reset the counter in par. 15-06 <i>Reset kWh Counter</i> .
--------	----------------------	--

15-03 Power Up's

Range:
Function:

0 N/A*	[0 - 2147483647 N/A]	View the number of times the frequency converter has been powered up.
--------	----------------------	---

15-04 Over Temp's

Range:
Function:

0 N/A*	[0 - 65535 N/A]	View the number of frequency converter temperature faults which have occurred.
--------	-----------------	--

15-05 Over Volt's

Range:
Function:

0 N/A*	[0 - 65535 N/A]	View the number of frequency converter overvoltages which have occurred.
--------	-----------------	--

15-06 Reset kWh Counter**Option:****Function:**

[0] * Do not reset

Select *Do not reset* [0] if no reset of the kWh counter is desired.

[1] Reset counter

Select *Reset* [1] and press [OK] to reset the kWh counter to zero (see par. 15-02 *kWh Counter*).**NB!**

The reset is carried out by pressing [OK].

3

15-07 Reset Running Hours Counter**Option:****Function:**

[0] * Do not reset

Select *Do not reset* [0] if no reset of the Running Hours counter is desired.

[1] Reset counter

Select *Reset counter* [1] and press [OK] to reset the Running Hours counter (par. 15-01 *Running Hours*) and par. 15-08 *Number of Starts* to zero (see also par. 15-01 *Running Hours*).**15-08 Number of Starts****Range:****Function:**

0 N/A* [0 - 2147483647 N/A]

This is a read out parameter only. The counter shows the numbers of starts and stops caused by a normal Start/Stop command and/or when entering/leaving sleep mode.

**NB!**This parameter will be reset when resetting par. 15-07 *Reset Running Hours Counter*.**3.15.3 Data Log Settings, 15-1 ***

The Data Log enables continuous logging of up to 4 data sources (par. 15-10 *Logging Source*) at individual rates (par. 15-11 *Logging Interval*). A trigger event (par. 15-12 *Trigger Event*) and window (par. 15-14 *Samples Before Trigger*) are used to start and stop the logging conditionally.

15-10 Logging Source

Array [4]

Option:**Function:**

Select which variables are to be logged.

[0] *	None
[1600]	Control Word
[1601]	Reference [Unit]
[1602]	Reference [%]
[1603]	Status Word
[1610]	Power [kW]
[1611]	Power [hp]
[1612]	Motor Voltage
[1613]	Frequency
[1614]	Motor Current
[1616]	Torque [Nm]
[1617]	Speed [RPM]
[1618]	Motor Thermal
[1622]	Torque [%]
[1630]	DC Link Voltage
[1632]	Brake Energy /s
[1633]	Brake Energy /2 min
[1634]	Heatsink Temp.
[1635]	Inverter Thermal
[1650]	External Reference
[1652]	Feedback [Unit]
[1654]	Feedback 1 [Unit]
[1655]	Feedback 2 [Unit]
[1656]	Feedback 3 [Unit]
[1660]	Digital Input
[1662]	Analog Input 53
[1664]	Analog Input 54
[1665]	Analog Output 42 [mA]
[1666]	Digital Output [bin]
[1675]	Analog In X30/11
[1676]	Analog In X30/12
[1677]	Analog Out X30/8 [mA]
[1690]	Alarm Word
[1691]	Alarm Word 2
[1692]	Warning Word
[1693]	Warning Word 2
[1694]	Ext. Status Word
[1695]	Ext. Status Word 2
[1830]	Analog Input X42/1
[1831]	Analog Input X42/3
[1832]	Analog Input X42/5
[1833]	Analog Out X42/7 [V]
[1834]	Analog Out X42/9 [V]
[1835]	Analog Out X42/11 [V]
[3110]	Bypass Status Word

15-11 Logging Interval

Range:

0 N/A* [0 - 86400.000 N/A]

Function:

Enter the interval in milliseconds between each sampling of the variables to be logged.

15-12 Trigger Event

Option:

Function:

Selects the trigger event. When the trigger event occurs, a window is applied to freeze the log. The log will then retain a specified percentage of samples before the occurrence of the trigger event (par. 15-14 *Samples Before Trigger*).

[0] * False

[1] True

[2] Running

[3] In range

[4] On reference

[5] Torque limit

[6] Current limit

[7] Out of current range

[8] Below I low

[9] Above I high

[10] Out of speed range

[11] Below speed low

[12] Above speed high

[13] Out of feedb. range

[14] Below feedb. low

[15] Above feedb. high

[16] Thermal warning

[17] Mains out of range

[18] Reversing

[19] Warning

[20] Alarm (trip)

[21] Alarm (trip lock)

[22] Comparator 0

[23] Comparator 1

[24] Comparator 2

[25] Comparator 3

[26] Logic rule 0

[27] Logic rule 1

[28] Logic rule 2

[29] Logic rule 3

[33] Digital input DI18

[34] Digital input DI19

[35] Digital input DI27

[36] Digital input DI29

[37] Digital input DI32

[38] Digital input DI33

[50] Comparator 4

[51] Comparator 5

[60] Logic rule 4

[61] Logic rule 5

15-13 Logging Mode**Option:****Function:**

[0] * Log always

Select *Log always* [0] for continuous logging.

[1] Log once on trigger

Select *Log once on trigger* [1] to conditionally start and stop logging using par. 15-12 *Trigger Event* and par. 15-14 *Samples Before Trigger*.**15-14 Samples Before Trigger****Range:****Function:**

50 N/A* [0 - 100 N/A]

Enter the percentage of all samples prior to a trigger event which are to be retained in the log. See also par. 15-12 *Trigger Event* and par. 15-13 *Logging Mode*.

3

3.15.4 Historic Log, 15-2*

View up to 50 logged data items via the array parameters in this parameter group. For all parameters in the group, [0] is the most recent data and [49] the oldest data. Data is logged every time an *event* occurs (not to be confused with SLC events). *Events* in this context are defined as a change in one of the following areas:

1. Digital input
2. Digital outputs (not monitored in this SW release)
3. Warning word
4. Alarm word
5. Status word
6. Control word
7. Extended status word

Events are logged with value, and time stamp in msec. The time interval between two events depends on how often *events* occur (maximum once every scan time). Data logging is continuous but if an alarm occurs, the log is saved and the values can be viewed on the display. This feature is useful, for example when carrying out service following a trip. View the historic log contained in this parameter via the serial communication port or via the display.

15-20 Historic Log: Event

Array [50]

Range:**Function:**

0 N/A* [0 - 255 N/A]

View the event type of the logged events.

15-21 Historic Log: Value

Array [50]

Range:**Function:**

0 N/A* [0 - 2147483647 N/A]

View the value of the logged event. Interpret the event values according to this table:

Digital input	Decimal value. See par. 16-60 <i>Digital Input</i> for description after converting to binary value.
Digital output (not monitored in this SW release)	Decimal value. See par. for description after converting to binary value.
Warning word	Decimal value. See par. 16-92 for description.
Alarm word	Decimal value. See par. 16-90 for description.
Status word	Decimal value. See par. 16-03 <i>Status Word</i> for description after converting to binary value.
Control word	Decimal value. See par. 16-00 <i>Control Word</i> for description.
Extended status word	Decimal value. See par. for description.

15-22 Historic Log: Time

Array [50]

Range:

0 ms* [0 - 2147483647 ms]

Function:

View the time at which the logged event occurred. Time is measured in ms since frequency converter start. The max. value corresponds to approx. 24 days which means that the count will restart at zero after this time period.

3.15.5 Alarm Log, 15-3*

Parameters in this group are array parameters, where up to 10 fault logs can be viewed. [0] is the most recent logged data, and [9] the oldest. Error codes, values, and time stamp can be viewed for all logged data.

15-30 Alarm Log: Error Code

Array [10]

Range:

0 N/A* [0 - 255 N/A]

Function:

View the error code and look up its meaning in the *Troubleshooting* chapter.

15-31 Alarm Log: Value

Array [10]

Range:

0 N/A* [-32767 - 32767 N/A]

Function:

View an extra description of the error. This parameter is mostly used in combination with alarm 38 'internal fault'.

15-32 Alarm Log: Time

Array [10]

Range:

0 s* [0 - 2147483647 s]

Function:

View the time when the logged event occurred. Time is measured in seconds from frequency converter start-up.

3.15.6 Alarm Log: Date and Time, 15-33**15-33 Alarm Log: Date and Time****Range:**

0 [0-0]

Function:

Array parameter; Date & Time 0 - 9: This parameter shows at which time the logged event occurred.

3.15.7 Drive Identification, 15-4*

Parameters containing read only information about the hardware and software configuration of the frequency converter.

15-40 FC Type**Range:**

0 N/A* [0 - 0 N/A]

Function:

View the FC type. The read-out is identical to the frequency converter series power field of the type code definition, characters 1-6.

15-41 Power Section**Range:**

0 N/A* [0 - 0 N/A]

Function:

View the FC type. The read-out is identical to the frequency converter series power field of the type code definition, characters 7-10.

15-42 Voltage**Range:**

0 N/A* [0 - 0 N/A]

Function:

View the FC type. The read-out is identical to the frequency converter series power field of the type code definition, characters 11-12.

15-43 Software Version**Range:**

0 N/A* [0 - 0 N/A]

Function:

View the combined SW version (or 'package version') consisting of power SW and control SW.

15-44 Ordered Typecode String**Range:**

0 N/A* [0 - 0 N/A]

Function:

View the type code string used for re-ordering the frequency converter in its original configuration.

15-45 Actual Typecode String**Range:**

0 N/A* [0 - 0 N/A]

Function:

View the actual type code string.

15-46 Frequency Converter Ordering No**Range:**

0 N/A* [0 - 0 N/A]

Function:

View the 8-digit ordering number used for re-ordering the frequency converter in its original configuration.

15-47 Power Card Ordering No**Range:**

0 N/A* [0 - 0 N/A]

Function:

View the power card ordering number.

15-48 LCP Id No**Range:**

0 N/A* [0 - 0 N/A]

Function:

View the LCP ID number.

15-49 SW ID Control Card**Range:**

0 N/A* [0 - 0 N/A]

Function:

View the control card software version number.

15-50 SW ID Power Card**Range:**

0 N/A* [0 - 0 N/A]

Function:

View the power card software version number.

15-51 Frequency Converter Serial Number**Range:**

0 N/A* [0 - 0 N/A]

Function:

View the frequency converter serial number.

15-53 Power Card Serial Number**Range:**

0 N/A* [0 - 0 N/A]

Function:

View the power card serial number.

3.15.8 Option Ident. 15-6*

This read-only parameter group contains information about the hardware and software configuration of the options installed in slots A, B C0 and C1.

15-60 Option Mounted**Range:**

0 N/A* [0 - 0 N/A]

Function:

View the installed option type.

15-61 Option SW Version**Range:**

0 N/A* [0 - 0 N/A]

Function:

View the installed option software version.

15-62 Option Ordering No**Range:**

0 N/A* [0 - 0 N/A]

Function:

Shows the ordering number for the installed options.

15-63 Option Serial No**Range:**

0 N/A* [0 - 0 N/A]

Function:

View the installed option serial number.

3.15.9 Parameter Info, 15-9*

Parameter lists

15-92 Defined Parameters

Array [1000]

Range:

0 N/A* [0 - 9999 N/A]

Function:

View a list of all defined parameters in the frequency converter. The list ends with 0.

15-93 Modified Parameters

Array [1000]

Range:

0 N/A* [0 - 9999 N/A]

Function:

View a list of the parameters that have been changed from their default setting. The list ends with 0. Changes may not be visible until up to 30 seconds after implementation.

15-99 Parameter Metadata

Array [23]

Range:

0 N/A* [0 - 9999 N/A]

Function:

This parameter contains data used by the MCT10 software tool.

3.16 Main Menu - Data Readouts - Group 16**3.16.1 16-** Data Readouts**

Parameter group for data read-outs, e.g. actual references, voltages, control, alarm, warning and status words.

3.16.2 16-0* General Status

Parameters for reading the general status, e.g. the calculated reference, the active control word, status.

16-00 Control Word**Range:**

0 N/A* [0 - 65535 N/A]

Function:

16-01 Reference [Unit]**Range:** **Function:**0.000 Ref- [-999999.000 - 999999.000 Refer-
erenceFeed-enceFeedbackUnit]
backUnit***16-02 Reference [%]****Range:** **Function:**

0.0 %* [-200.0 - 200.0 %]

16-03 Status Word**Range:** **Function:**

0 N/A* [0 - 65535 N/A]

16-05 Main Actual Value [%]**Range:** **Function:**

0.00 %* [-100.00 - 100.00 %] View the two-byte word sent with the Status word to the bus Master reporting the Main Actual Value.

16-09 Custom Readout**Range:** **Function:**0.00 Cus- [-999999.99 - 999999.99 Custom-
tomReadou-ReadoutUnit]
tUnit***3.16.3 16-1* Motor Status**

Parameters for reading the motor status values.

16-10 Power [kW]**Range:** **Function:**

0.00 kW* [0.00 - 1000.00 kW]

16-11 Power [hp]**Range:** **Function:**

0.00 hp* [0.00 - 1000.00 hp]

16-12 Motor Voltage**Range:** **Function:**

0.0 V* [0.0 - 6000.0 V]

16-13 Frequency**Range:** **Function:**

0.0 Hz* [0.0 - 6500.0 Hz]

16-14 Motor Current**Range:** **Function:**

0.00 A* [0.00 - 1856.00 A]

16-15 Frequency [%]**Range:** **Function:**

0.00 %* [-100.00 - 100.00 %]

16-16 Torque [Nm]	
Range:	Function:
0.0 Nm* [-30000.0 - 30000.0 Nm]	
16-17 Speed [RPM]	
Range:	Function:
0 RPM* [-30000 - 30000 RPM]	
16-18 Motor Thermal	
Range:	Function:
0 %* [0 - 100 %]	
16-22 Torque [%]	
Range:	Function:
0 %* [-200 - 200 %]	

3.16.4 16-3* Drive Status

Parameters for reporting the status of the frequency converter.

16-30 DC Link Voltage	
Range:	Function:
0 V* [0 - 10000 V]	
16-32 Brake Energy /s	
Range:	Function:
0.000 kW* [0.000 - 675000.000 kW]	
16-33 Brake Energy /2 min	
Range:	Function:
0.000 kW* [0.000 - 500.000 kW]	
16-34 Heatsink Temp.	
Range:	Function:
0 C* [0 - 255 C]	
16-35 Inverter Thermal	
Range:	Function:
0 %* [0 - 100 %]	
16-36 Inv. Nom. Current	
Range:	Function:
10.00 A* [0.01 - 10000.00 A]	View the inverter nominal current, which should match the nameplate data on the connected motor. The data are used for calculation of torque, motor protection, etc.
16-37 Inv. Max. Current	
Range:	Function:
16.00 A* [0.01 - 10000.00 A]	View the inverter maximum current, which should match the nameplate data on the connected motor. The data are used for calculation of torque, motor protection, etc.
16-38 SL Controller State	
Range:	Function:
0 N/A* [0 - 100 N/A]	

16-39 Control Card Temp.**Range:** **Function:**

0 C* [0 - 100 C]

16-40 Logging Buffer Full**Option:** **Function:**View whether the logging buffer is full (see par. 15-1*). The logging buffer will never be full when par. 15-13 *Logging Mode* is set to *Log always* [0].

[0]* No

[1] Yes

3.16.5 16-5* Ref. & Feedb.

Parameters for reporting the reference and feedback input.

16-50 External Reference**Range:** **Function:**

0.0 N/A* [-200.0 - 200.0 N/A]

16-52 Feedback [Unit]**Range:** **Function:**0.000 Proc- [-999999.999 - 999999.999 Proc-
essCtrlU- essCtrlUnit]
nit***16-53 Digi Pot Reference****Range:** **Function:**

0.00 N/A* [-200.00 - 200.00 N/A]

16-54 Feedback 1 [Unit]**Range:** **Function:**0.000 Proc- [-999999.999 - 999999.999 Proc-
essCtrlU- essCtrlUnit]
nit***16-55 Feedback 2 [Unit]****Range:** **Function:**0.000 Proc- [-999999.999 - 999999.999 Proc-
essCtrlU- essCtrlUnit]
nit***16-56 Feedback 3 [Unit]****Range:** **Function:**0.000 Proc- [-999999.999 - 999999.999 Proc-
essCtrlU- essCtrlUnit]
nit***16-58 PID Output [%]****Range:** **Function:**

0.0 %* [0.0 - 100.0 %] This parameter returns the Drive Closed Loop PID controller output value in percent.

3.16.6 16-6* Inputs and Outputs

Parameters for reporting the digital and analog IO ports.

16-60 Digital Input	
Range:	Function:
0 N/A* [0 - 1023 N/A]	
16-61 Terminal 53 Switch Setting	
Option:	Function:
	View the setting of input terminal 53. Current = 0; Voltage = 1.
[0] * Current	
[1] Voltage	
[2] Pt 1000 [°C]	
[3] Pt 1000 [°F]	
[4] Ni 1000 [°C]	
[5] Ni 1000 [°F]	
16-62 Analog Input 53	
Range:	Function:
0.000 N/A* [-20.000 - 20.000 N/A]	
16-63 Terminal 54 Switch Setting	
Option:	Function:
	View the setting of input terminal 54. Current = 0; Voltage = 1.
[0] * Current	
[1] Voltage	
[2] Pt 1000 [°C]	
[3] Pt 1000 [°F]	
[4] Ni 1000 [°C]	
[5] Ni 1000 [°F]	
16-64 Analog Input 54	
Range:	Function:
0.000 N/A* [-20.000 - 20.000 N/A]	
16-65 Analog Output 42 [mA]	
Range:	Function:
0.000 N/A* [0.000 - 30.000 N/A]	
16-66 Digital Output [bin]	
Range:	Function:
0 N/A* [0 - 15 N/A]	
16-67 Pulse Input #29 [Hz]	
Range:	Function:
0 N/A* [0 - 130000 N/A]	View the actual frequency rate on terminal 29.
16-68 Pulse Input #33 [Hz]	
Range:	Function:
0 N/A* [0 - 130000 N/A]	View the actual value of the frequency applied at terminal 33 as an impulse input.

16-69 Pulse Output #27 [Hz]**Range:**

0 N/A* [0 - 40000 N/A]

Function:

View the actual value of impulses applied to terminal 27 in digital output mode.

16-70 Pulse Output #29 [Hz]**Range:**

0 N/A* [0 - 40000 N/A]

Function:

View the actual value of pulses to terminal 29 in digital output mode.

16-71 Relay Output [bin]**Range:**

0 N/A* [0 - 31 N/A]

Function:**16-72 Counter A****Range:**

0 N/A* [-2147483648 - 2147483647 N/A]

Function:**16-73 Counter B****Range:**

0 N/A* [-2147483648 - 2147483647 N/A]

Function:**16-75 Analog In X30/11****Range:**

0.000 N/A* [-20.000 - 20.000 N/A]

Function:**16-76 Analog In X30/12****Range:**

0.000 N/A* [-20.000 - 20.000 N/A]

Function:**16-77 Analog Out X30/8 [mA]****Range:**

0.000 N/A* [0.000 - 30.000 N/A]

Function:**3.16.7 16-8* Fieldbus & FC Port**

Parameters for reporting the BUS references and control words.

16-80 Fieldbus CTW 1**Range:**

0 N/A* [0 - 65535 N/A]

Function:**16-82 Fieldbus REF 1****Range:**

0 N/A* [-200 - 200 N/A]

Function:**16-84 Comm. Option STW****Range:**

0 N/A* [0 - 65535 N/A]

Function:**16-85 FC Port CTW 1****Range:**

0 N/A* [0 - 65535 N/A]

Function:

16-86 FC Port REF 1	
Range:	Function:
0 N/A* [-200 - 200 N/A]	

3.16.8 16-9* Diagnosis Read-Out

Parameters displaying alarm, warning and extended status words.

16-90 Alarm Word	
Range:	Function:
0 N/A* [0 - 4294967295 N/A]	

16-91 Alarm Word 2	
Range:	Function:
0 N/A* [0 - 4294967295 N/A]	

16-92 Warning Word	
Range:	Function:
0 N/A* [0 - 4294967295 N/A]	

16-93 Warning Word 2	
Range:	Function:
0 N/A* [0 - 4294967295 N/A]	

16-94 Ext. Status Word	
Range:	Function:
0 N/A* [0 - 4294967295 N/A]	

16-95 Ext. Status Word 2	
Range:	Function:
0 N/A* [0 - 4294967295 N/A]	

16-96 Maintenance Word	
Range:	Function:
0 N/A* [0 - 4294967295 N/A]	

3.17 Main Menu - Data Readouts 2 - Group 18

3.17.1 18-0* Maintenance Log

This group contains the last 10 Preventive Maintenance logs. Maintenance Log 0 is the latest log and Maintenance Log 9 the oldest. By selecting one of the logs and pressing OK, the Maintenance Item, Action and time of the occurrence can be found in par. 18-00 *Maintenance Log: Item* – par. 18-03 *Maintenance Log: Date and Time*.

The Alarm log button on the LCP allows access to both Alarm log and Maintenance log.

18-00 Maintenance Log: Item	
Range:	Function:
Array [10]	
0 N/A* [0 - 255 N/A]	Locate the meaning of the Maintenance Item in the description of par. 23-10 <i>Maintenance Item</i> .

18-01 Maintenance Log: Action

Array [10]

Range:

0 N/A* [0 - 255 N/A]

Function:Locate the meaning of the Maintenance Item in the description of par. 23-11 *Maintenance Action***18-02 Maintenance Log: Time**

Array [10]

Range:

0 s* [0 - 2147483647 s]

Function:

Shows when the logged event occurred. Time is measured in seconds since last power-up.

18-03 Maintenance Log: Date and Time

Array [10]

Range:

0 N/A* [0 - 0 N/A]

Function:

Shows when the logged event occurred.

**NB!**This requires that the date and time is programmed in par. 0-70 *Date and Time*.Date format depends on the setting in par. 0-71 *Date Format*, while the time format depends on the setting in par. 0-72 *Time Format*.**NB!**The frequency converter has no back up of the clock function and the set date/ time will reset to default (2000-01-01 00:00) after a power down unless a Real Time Clock module with back up is installed. In par. 0-79 *Clock Fault* it is possible to program for a Warning in case clock has not been set properly, e.g. after a power down. Incorrect setting of the clock will affect the time stamps for the Maintenance Events.**NB!**

When mounting an Analog I/O MCB 109 option card, a battery back-up of date and time is included.

3.17.2 18-1* Fire Mode Log

The log covers the latest 10 faults which have been suppressed by the Fire Mode function. See *par. 24-0*, Fire Mode*. The log can be viewed either via the below parameters or by pressing the Alarm Log button on the Local Control Panel and select Fire Mode Log. It is not possible to reset the Fire Mode Log.

18-10 Fire Mode Log: Event**Range:**

0 N/A* [0 - 255 N/A]

Function:

This parameter contains an array with 10 elements. The number read represent an error code, which corresponds to a specific alarm. This can be found in the Troubleshooting section in the Design Guide.

18-11 Fire Mode Log: Time**Range:**

0 s* [0 - 2147483647 s]

Function:

This parameter contains an array with 10 elements. The parameter shows at which time the logged event occurred. Time is measured in seconds since the first start of the motor.

18-12 Fire Mode Log: Date and Time

Range:

0 N/A* [0 - 0 N/A]

Function:

This parameter contains an array with 10 elements. The parameter shows at which date and time the logged event occurred. The function relies on that the actual date and time has been set in par. 0-70 *Date and Time*. Note: There is no build in battery back up of the clock. An external back up must be used, eg the one in the MCB109 Analog I/O option card. See Clock Settings, 0-7*.

3.17.3 18-3* Analog I/O

18-30 Analog Input X42/1

Range:

0.000 N/A* [-20.000 - 20.000 N/A]

Function:

Read out of the value of the signal applied to terminal X42/1 on the Analog I/O Card. The units of the value shown in the LCP will correspond to the mode selected in par.26-00, Terminal X/42-1 Mode.

18-31 Analog Input X42/3

Range:

0.000 N/A* [-20.000 - 20.000 N/A]

Function:

Read out of the value of the signal applied to terminal X42/3 on the Analog I/O Card. The units of the value shown in the LCP will correspond to the mode selected in par. 26-01 *Terminal X42/3 Mode*.

18-32 Analog Input X42/5

Range:

0.000 N/A* [-20.000 - 20.000 N/A]

Function:

Read out of the value of the signal applied to terminal X42/5 on the Analog I/O Card. The units of the value shown in the LCP will correspond to the mode selected in par. 26-02 *Terminal X42/5 Mode*.

18-33 Analog Out X42/7 [V]

Range:

0.000 N/A* [0.000 - 30.000 N/A]

Function:

Read out of the value of the signal applied to terminal X42/7 on the Analog I/O Card. The value shown reflects the selection in par. 26-40 *Terminal X42/7 Output*.

18-34 Analog Out X42/9 [V]

Range:

0.000 N/A* [0.000 - 30.000 N/A]

Function:

Read out of the value of the signal applied to terminal X42/9 on the Analog I/O Card. The value shown reflects the selection in par. 26-50 *Terminal X42/9 Output*.

18-35 Analog Out X42/11 [V]

Range:

0.000 N/A* [0.000 - 30.000 N/A]

Function:

Read out of the value of the signal applied to terminal X42/11 on the Analog I/O Card. The value shown reflects the selection in par. 26-60 *Terminal X42/11 Output*.

3.18 Main Menu - FC Closed Loop - Group 20

3.18.1 20-** FC Closed Loop

This parameter group is used for configuring the closed loop PID Controller, that controls the output frequency of the frequency converter.

3.18.2 20-0* Feedback

This parameter group is used to configure the feedback signal for the frequency converter's closed loop PID Controller. Whether the frequency converter is in Closed Loop Mode or Open Loop Mode, the feedback signals can also be shown on the frequency converter's display, be used to control a frequency converter analog output, and be transmitted over various serial communication protocols.

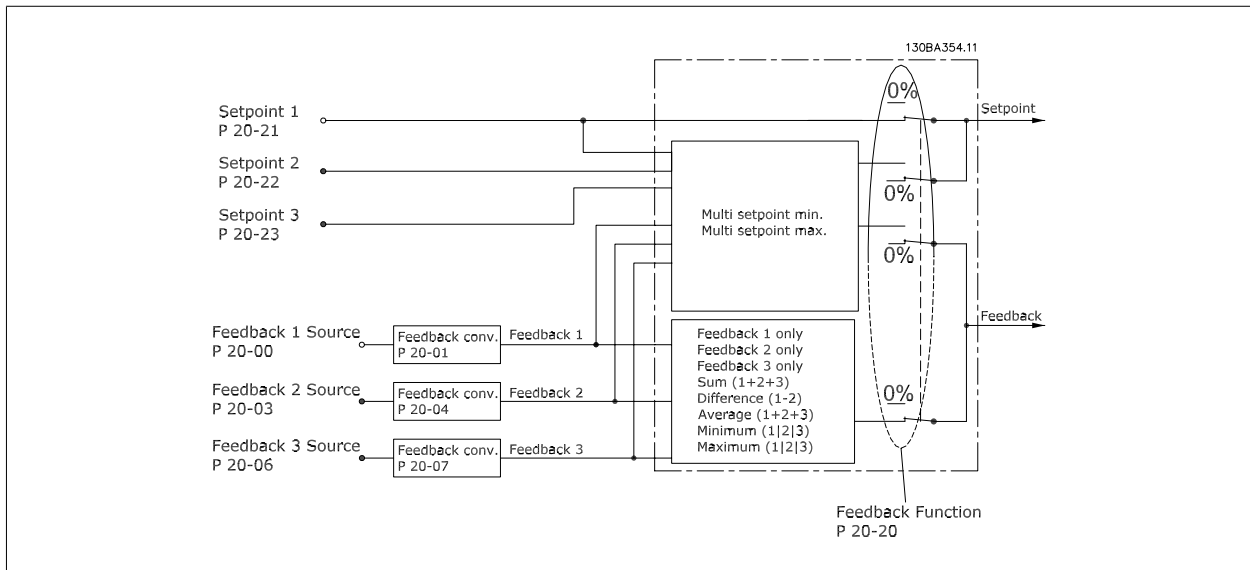

20-00 Feedback 1 Source

Option:

Function:

Up to three different feedback signals can be used to provide the feedback signal for the frequency converter's PID Controller.
 This parameter defines which input will be used as the source of the first feedback signal.
 Analog input X30/11 and Analog input X30/12 refer to inputs on the optional General Purpose I/O board.

- [0] No function
- [1] Analog input 53
- [2] * Analog input 54
- [3] Pulse input 29
- [4] Pulse input 33
- [7] Analog input X30/11
- [8] Analog input X30/12
- [9] Analog Input X42/1
- [10] Analog Input X42/3
- [11] Analog Input X42/5
- [100] Bus feedback 1
- [101] Bus feedback 2
- [102] Bus feedback 3



NB!

If a feedback is not used, its source must be set to *No Function* [0]. par. 20-20 *Feedback Function* determines how the three possible feedbacks will be used by the PID Controller.

20-01 Feedback 1 Conversion

Option:
Function:

This parameter allows a conversion function to be applied to Feedback 1.

[0] *	Linear	<i>Linear</i> [0] has no effect on the feedback.
[1]	Square root	<i>Square root</i> [1] is commonly used when a pressure sensor is used to provide flow feedback (($flow \propto \sqrt{pressure}$)).
[2]	Pressure to temperature	<p><i>Pressure to temperature</i> [2] is used in compressor applications to provide temperature feedback using a pressure sensor. The temperature of the refrigerant is calculated using the following formula:</p> $Temperature = \frac{A2}{(\ln(Pe + 1) - A1)} - A3$ <p>where A1, A2 and A3 are refrigerant-specific constants. The refrigerant must be selected in par. 20-30 <i>Refrigerant</i>. par. 20-21 <i>Setpoint 1</i> through par. 20-23 <i>Setpoint 3</i> allow the values of A1, A2 and A3 to be entered for a refrigerant that is not listed in par. 20-30 <i>Refrigerant</i>.</p>

20-02 Feedback 1 Source Unit

Option:
Function:

This parameter determines the unit that is used for this Feedback Source, prior to applying the feedback conversion of par. 20-01 *Feedback 1 Conversion*. This unit is not used by the PID Controller.

[0] *	
[1]	%
[5]	PPM
[10]	1/min
[11]	RPM
[12]	Pulse/s
[20]	l/s
[21]	l/min
[22]	l/h
[23]	m ³ /s
[24]	m ³ /min
[25]	m ³ /h
[30]	kg/s
[31]	kg/min
[32]	kg/h
[33]	t/min
[34]	t/h
[40]	m/s
[41]	m/min
[45]	m
[60]	°C
[70]	mbar
[71]	bar
[72]	Pa
[73]	kPa
[74]	m WG
[75]	mm Hg
[80]	kW

[120]	GPM
[121]	gal/s
[122]	gal/min
[123]	gal/h
[124]	CFM
[125]	ft ³ /s
[126]	ft ³ /min
[127]	ft ³ /h
[130]	lb/s
[131]	lb/min
[132]	lb/h
[140]	ft/s
[141]	ft/min
[145]	ft
[160]	°F
[170]	psi
[171]	lb/in ²
[172]	in WG
[173]	ft WG
[174]	in Hg
[180]	HP

**NB!**

This parameter is only available when using pressure to temperature feedback conversion.

If the choice Linear [0] is selected in par. 20-01, then the setting of any choice in par. 20-02 does not matter as conversion will be one-to-one.

20-03 Feedback 2 Source

Option:**Function:**

See par. 20-00 *Feedback 1 Source* for details.

[0] *	No function
[1]	Analog input 53
[2]	Analog input 54
[3]	Pulse input 29
[4]	Pulse input 33
[7]	Analog input X30/11
[8]	Analog input X30/12
[9]	Analog Input X42/1
[10]	Analog Input X42/3
[11]	Analog Input X42/5
[100]	Bus feedback 1
[101]	Bus feedback 2
[102]	Bus feedback 3

20-04 Feedback 2 Conversion

Option: **Function:**

See par. 20-01 *Feedback 1 Conversion* for details.

- [0] * Linear
- [1] Square root
- [2] Pressure to temperature

20-05 Feedback 2 Source Unit

Option: **Function:**

See par. 20-02 *Feedback 1 Source Unit* for details.

- [0] *
- [1] %
- [5] PPM
- [10] 1/min
- [11] RPM
- [12] Pulse/s
- [20] l/s
- [21] l/min
- [22] l/h
- [23] m³/s
- [24] m³/min
- [25] m³/h
- [30] kg/s
- [31] kg/min
- [32] kg/h
- [33] t/min
- [34] t/h
- [40] m/s
- [41] m/min
- [45] m
- [60] °C
- [70] mbar
- [71] bar
- [72] Pa
- [73] kPa
- [74] m WG
- [75] mm Hg
- [80] kW
- [120] GPM
- [121] gal/s
- [122] gal/min
- [123] gal/h
- [124] CFM
- [125] ft³/s
- [126] ft³/min
- [127] ft³/h
- [130] lb/s

[131] lb/min

[132] lb/h

[140] ft/s

[141] ft/min

[145] ft

[160] °F

[170] psi

[171] lb/in²

[172] in WG

[173] ft WG

[174] in Hg

[180] HP

20-06 Feedback 3 Source**Option:****Function:**See par. 20-00 *Feedback 1 Source* for details.

[0] * No function

[1] Analog input 53

[2] Analog input 54

[3] Pulse input 29

[4] Pulse input 33

[7] Analog input X30/11

[8] Analog input X30/12

[9] Analog Input X42/1

[10] Analog Input X42/3

[11] Analog Input X42/5

[100] Bus feedback 1

[101] Bus feedback 2

[102] Bus feedback 3

20-07 Feedback 3 Conversion**Option:****Function:**See par. 20-01 *Feedback 1 Conversion* for details.

[0] * Linear

[1] Square root

[2] Pressure to temperature

20-08 Feedback 3 Source Unit**Option:****Function:**See par. 20-02 *Feedback 1 Source Unit* for details.

[0] *

[1] %

[5] PPM

[10] 1/min

[11] RPM

[12] Pulse/s

[20] l/s

[21] l/min

[22]	l/h
[23]	m ³ /s
[24]	m ³ /min
[25]	m ³ /h
[30]	kg/s
[31]	kg/min
[32]	kg/h
[33]	t/min
[34]	t/h
[40]	m/s
[41]	m/min
[45]	m
[60]	°C
[70]	mbar
[71]	bar
[72]	Pa
[73]	kPa
[74]	m WG
[75]	mm Hg
[80]	kW
[120]	GPM
[121]	gal/s
[122]	gal/min
[123]	gal/h
[124]	CFM
[125]	ft ³ /s
[126]	ft ³ /min
[127]	ft ³ /h
[130]	lb/s
[131]	lb/min
[132]	lb/h
[140]	ft/s
[141]	ft/min
[145]	ft
[160]	°F
[170]	psi
[171]	lb/in ²
[172]	in WG
[173]	ft WG
[174]	in Hg
[180]	HP

20-12 Reference/Feedback Unit

Option:

Function:

This parameter determines the unit that is used for the setpoint reference and feedback that the PID Controller will use for controlling the output frequency of the frequency converter.

[0] *

[1]	%
[5]	PPM
[10]	1/min
[11]	RPM
[12]	Pulse/s
[20]	l/s
[21]	l/min
[22]	l/h
[23]	m ³ /s
[24]	m ³ /min
[25]	m ³ /h
[30]	kg/s
[31]	kg/min
[32]	kg/h
[33]	t/min
[34]	t/h
[40]	m/s
[41]	m/min
[45]	m
[60]	°C
[70]	mbar
[71]	bar
[72]	Pa
[73]	kPa
[74]	m WG
[75]	mm Hg
[80]	kW
[120]	GPM
[121]	gal/s
[122]	gal/min
[123]	gal/h
[124]	CFM
[125]	ft ³ /s
[126]	ft ³ /min
[127]	ft ³ /h
[130]	lb/s
[131]	lb/min
[132]	lb/h
[140]	ft/s
[141]	ft/min
[145]	ft
[160]	°F
[170]	psi
[171]	lb/in ²
[172]	in WG
[173]	ft WG
[174]	in Hg

[180] HP

20-13 Minimum Reference/Feedb.

Range:

0.000 Proc- [-999999.999 - par. 20-14 Proc-
essCtrlU- essCtrlUnit]
nit*

Function:

Enter the desired minimum value for the remote reference when operating with par. 1-00, Configuration Mode set for Closed Loop [3] operation. Units are set in par. 20-12, Reference/Feedback Unit.

Minimum feedback will be -200% of either the value set in par. 20-13 or in par. 20-14, whichever numeric value is the highest.



NB!

If operating with par.1-00, Configuration Mode set for Open Loop [0], par. 3-02, Minimum Reference must be used.

20-14 Maximum Reference/Feedb.

Range:

100.000 [par. 20-13 - 999999.999 Proc-
ProcessCtr- essCtrlUnit]
lUnit*

Function:

Enter the maximum acceptable value for the remote reference when operating with par. 1-00, Configuration Reference set for Closed Loop [3]. Units are set in par. 20-12, Reference/Feedback Unit.

The maximum possible feedback value will be +200% of either the value set in par. 20-13 or par. 20-14, whichever numeric number is the highest.

Example: Setting par. 20-13 to 0 Bar and par. 20-14 to 6 Bar will generate a feedback value range between -12 and +12 Bar.

Setting par. 20-13 to -20 °C and par. 20-14 to +10 °C will generate a feedback value range between -40 °C and +40 °C.

NB!

If operating with par. 1-00, Configuration Mode set for Open Loop [0], par. 3-03, Maximum Reference must be used.



NB!

The dynamics of the PID controller will depend on the value set in this parameter. Please see also par. 20-93, *PID Proportional Gain*. Par. 20-13 and par. 20-14 also determine the feedback range when using feedback for display readout with par. 1-00, Configuration Mode set for Open Loop [0]. Same condition as above.

3.18.3 20-2* Feedback & Setpoint

This parameter group is used to determine how the frequency converter's PID Controller will use the three possible feedback signals to control the output frequency of the frequency converter. This group is also used to store the three internal setpoint references.

20-20 Feedback Function

Option:

[0] Sum

Function:

This parameter determines how the three possible feedbacks will be used to control the output frequency of the frequency converter.

Sum [0] sets up the PID Controller to use the sum of Feedback 1, Feedback 2 and Feedback 3 as the feedback.



NB!

Any unused feedbacks must be set to *No Function* in par. 20-00 *Feedback 1 Source*, par. 20-03 *Feedback 2 Source*, or par. 20-06 *Feedback 3 Source*.

The sum of Setpoint 1 and any other references that are enabled (see par. group 3-1*) will be used as the PID Controller's set-point reference.

[1] Difference
Difference [1] sets up the PID controller to use the difference between Feedback 1 and Feedback 2 as the feedback. Feedback 3 will not be used with this selection. Only Setpoint 1 will be used. The sum of Setpoint 1 and any other references that are enabled (see par. group 3-1*) will be used as the PID controller's set-point reference.

[2] Average
Average [2] sets up the PID Controller to use the average of Feedback 1, Feedback 2 and Feedback 3 as the feedback.

**NB!**

Any unused feedbacks must be set to *No Function* in par. 20-00 *Feedback 1 Source*, par. 20-03 *Feedback 2 Source*, or par. 20-06 *Feedback 3 Source*. The sum of Setpoint 1 and any other references that are enabled (see par. group 3-1*) will be used as the PID Controller's set-point reference.

[3] * Minimum
Minimum [3] sets up the PID Controller to compare Feedback 1, Feedback 2 and Feedback 3 and use the lowest value as the feedback.

**NB!**

Any unused feedbacks must be set to *No Function* in par. 20-00 *Feedback 1 Source*, par. 20-03 *Feedback 2 Source*, or par. 20-06 *Feedback 3 Source*. Only setpoint 1 will be used. The sum of Setpoint 1 and any other references that are enabled (see par. group 3-1*) will be used as the PID Controller's setpoint reference.

[4] Maximum
Maximum [4] sets up the PID Controller to compare Feedback 1, Feedback 2 and Feedback 3 and use the highest value as the feedback.

**NB!**

Any unused feedbacks must be set to *No Function* in par. 20-00 *Feedback 1 Source*, par. 20-03 *Feedback 2 Source*, or par. 20-06 *Feedback 3 Source*.

Only Setpoint 1 will be used. The sum of Setpoint 1 and any other references that are enabled (see par. group 3-1*) will be used as the PID Controller's setpoint reference.

[5] Multi Setpoint Min
Multi-setpoint minimum [5] sets up the PID Controller to calculate the difference between Feedback 1 and Setpoint 1, Feedback 2 and Setpoint 2, and Feedback 3 and Setpoint 3. It will use the feedback/setpoint pair in which the feedback is the farthest below its corresponding setpoint reference. If all feedback signals are above their corresponding setpoints, the PID Controller will use the feedback/setpoint pair in which the difference between the feedback and setpoint is the least.

**NB!**

If only two feedback signals are used, the feedback that is not to be used must be set to *No Function* in par. 20-00 *Feedback 1 Source*, par. 20-03 *Feedback 2 Source* or par. 20-06 *Feedback 3 Source*. Note that each setpoint reference will be the sum of its respective parameter value (par. 20-21 *Setpoint 1*, par. 20-22 *Setpoint 2* and par. 20-23 *Setpoint 3*) and any other references that are enabled (see par. group 3-1*).

[6] Multi Setpoint Max
Multi-setpoint maximum [6] sets up the PID Controller to calculate the difference between Feedback 1 and Setpoint 1, Feedback 2 and Setpoint 2, and Feedback 3 and Setpoint 3. It will use the feedback/setpoint pair in which the feedback is farthest above its corresponding setpoint reference. If all feedback signals are below their corresponding setpoints, the PID Controller will use the feedback/setpoint pair in which the difference between the feedback and the setpoint reference is the least.

NB!
 If only two feedback signals are used, the feedback that is not to be used must be set to *No Function* in par. 20-00 *Feedback 1 Source*, par. 20-03 *Feedback 2 Source* or par. 20-06 *Feedback 3 Source*. Note that each setpoint reference will be the sum of its respective parameter value (par. 20-21 *Setpoint 1*, par. 20-22 *Setpoint 2* and par. 20-23 *Setpoint 3*) and any other references that are enabled (see par. group 3-1*).

NB!
 Any unused feedback must be set to "No function" in its Feedback Source parameter: par. 20-00 *Feedback 1 Source*, par. 20-03 *Feedback 2 Source* or par. 20-06 *Feedback 3 Source*.

The feedback resulting from the function selected in par. 20-20 *Feedback Function* will be used by the PID Controller to control the output frequency of the frequency converter. This feedback can also be shown on the frequency converter's display, be used to control a frequency converter's analog output, and be transmitted over various serial communication protocols.

The frequency converter can be configured to handle multi zone applications. Two different multi zone applications are supported:

- Multi zone, single setpoint
- Multi zone, multi setpoint

The difference between the two is illustrated by the following examples:

Example 1 – Multi zone, single setpoint

In an office building, a VAV (variable air volume) VLT HVAC Drive system must ensure a minimum pressure at selected VAV boxes. Due to the varying pressure losses in each duct, the pressure at each VAV box cannot be assumed to be the same. The minimum pressure required is the same for all VAV boxes. This control method can be set up by setting par. 20-20 *Feedback Function* to option [3], Minimum, and entering the desired pressure in par. 20-21 *Setpoint 1*. The PID Controller will increase the speed of the fan if any one feedback is below the setpoint and decrease the speed of the fan if all feedbacks are above the setpoint.

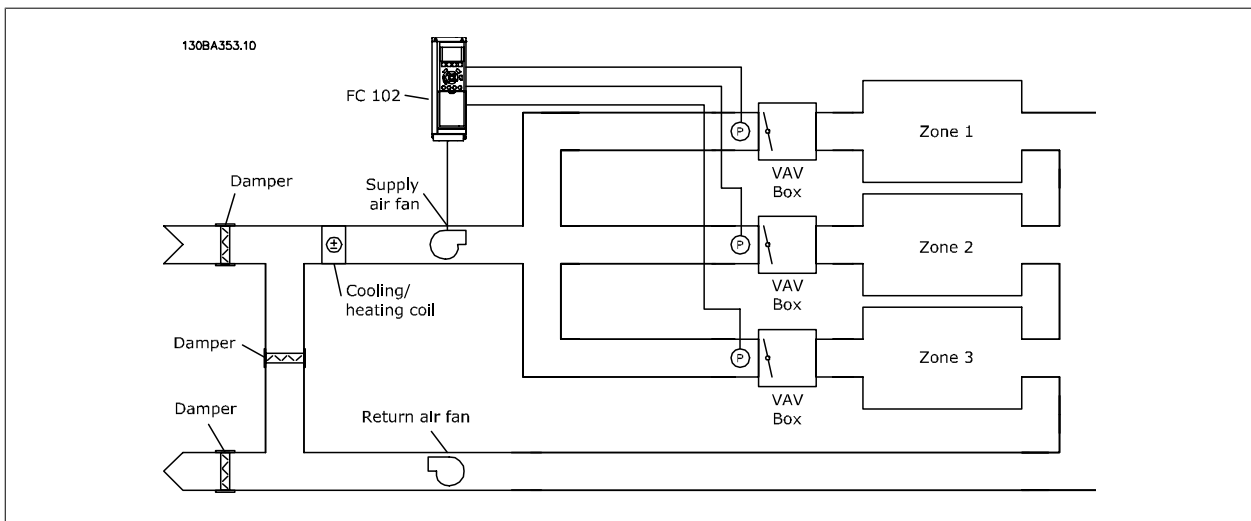

Example 2 – Multi zone, multi setpoint

The previous example can be used to illustrate the use of multi zone, multi setpoint control. If the zones require different pressures for each VAV box, each setpoint may be specified in par. 20-21 *Setpoint 1*, par. 20-22 *Setpoint 2* and par. 20-23 *Setpoint 3*. By selecting *Multi setpoint minimum*, [5], in par. 20-20 *Feedback Function*, the PID Controller will increase the speed of the fan if any one of the feedbacks is below its setpoint and decrease the speed of the fan if all feedbacks are above their individual setpoints.

20-21 Setpoint 1**Range:**

0.000 Proc- [-999999.999 - 999999.999 Proc-
essCtrlU- essCtrlUnit]
nit*

Function:

Setpoint 1 is used in Closed Loop Mode to enter a setpoint reference that is used by the frequency converter's PID Controller. See the description of par. 20-20 *Feedback Function*.

**NB!**

Setpoint reference entered here is added to any other references that are enabled (see par. group 3-1*).

20-22 Setpoint 2**Range:**

0.000 Proc- [-999999.999 - 999999.999 Proc-
essCtrlU- essCtrlUnit]
nit*

Function:

Setpoint 2 is used in Closed Loop Mode to enter a setpoint reference that may be used by the frequency converter's PID Controller. See the description of *Feedback Function*, par. 20-20 *Feedback Function*.

**NB!**

The setpoint reference entered here is added to any other references that are enabled (see par. group 3-1*).

20-23 Setpoint 3**Range:**

0.000 Proc- [-999999.999 - 999999.999 Proc-
essCtrlU- essCtrlUnit]
nit*

Function:

Setpoint 3 is used in Closed Loop Mode to enter a setpoint reference that may be used by the frequency converter's PID Controller. See the description of par. 20-20 *Feedback Function*.

**NB!**

The setpoint reference entered here is added to any other references that are enabled (see par. group 3-1*).

3.18.4 20-3* Feedback Adv. Conversion

In air conditioning compressor applications it is often useful to control the system based on the temperature of the refrigerant. However, it is generally more convenient to directly measure its pressure. This parameter group allows the frequency converter's PID Controller to convert refrigerant pressure measurements into temperature values.

20-30 Refrigerant

Option:

Function:

Select the refrigerant used in the compressor application. This parameter must be specified correctly for the pressure to temperature conversion to be accurate. If the refrigerant used is not listed in choices [0] through [6], select *User defined* [7]. Then, use par. 20-31 *User Defined Refrigerant A1*, par. 20-32 *User Defined Refrigerant A2* and par. 20-33 *User Defined Refrigerant A3* to provide A1, A2 and A3 for the equation below:

$$Temperature = \frac{A2}{(\ln(Pe + 1) - A1)} - A3$$

[0] * R22

[1] R134a

[2] R404A

[3] R407C

[4] R410A

[5] R502

[6] R744

[7] User defined

20-31 User Defined Refrigerant A1

Range:

Function:

10.0000 N/ [8.0000 - 12.0000 N/A]
A*

Use this parameter to enter the value of coefficient A1 when par. 20-30 *Refrigerant* is set to *User defined* [7].

20-32 User Defined Refrigerant A2

Range:

Function:

-2250.00 N/ [-3000.00 - -1500.00 N/A]
A*

Use this parameter to enter the value of coefficient A2 when par. 20-30 *Refrigerant* is set to *User defined* [7].

20-33 User Defined Refrigerant A3

Range:

Function:

250.000 N/ [200.000 - 300.000 N/A]
A*

Use this parameter to enter the value of coefficient A3 when par. 20-30 *Refrigerant* is set to *User defined* [7].

3.18.5 20-7* PID autotuning

The frequency converter PID Closed Loop controller (parameters 20-**, FC Closed Loop) can be auto-tuned, simplifying and saving time during commissioning, whilst ensuring accurate PID control adjustment. To use auto-tuning it is necessary for the frequency converter to be configured for closed loop in par. 1-00 Configuration Mode.

A Graphical Local Control Panel (LCP) must be used in order to react on messages during the auto-tuning sequence.

Enabling par. 20-79 *PID Autotuning*, puts the frequency converter into auto-tuning mode. The LCP then directs the user with on-screen instructions.

The fan/pump is started by pressing [Auto On] button on the LCP and applying a start signal. The speed is adjusted manually by pressing the [▲] or [▼] navigation keys on the LCP to a level where the feedback is around the system set-point.

NB!
It is not possible to run the motor at maximum or minimum speed, when manually adjusting the motor speed due to the need of giving the motor a step in the speed during auto-tuning.

PID auto-tuning functions by introducing step changes whilst operating at a steady state and then monitoring the feedback. From the feedback response, the required values for par. 20-93 *PID Proportional Gain* and par 20-94 *Integral Time* are calculated. par. 20-95 *PID Differentiation Time* is set to value 0 (zero). par. 20-81 *PID Normal/ Inverse Control* is determined during tuning process.

These calculated values are presented on the LCP and the user can decide whether to accept or reject them. Once accepted, the values are written to the relevant parameters and auto-tuning mode is disabled in par 20-79. Depending on the system being controlled the time required to carry out auto-tuning could be several minutes.

It is advised to set the ramp times in par. 3-41 *Ramp 1 Ramp Up Time*, par. 3-42 *Ramp 1 Ramp Down Time* or par. 3-51 *Ramp 2 Ramp Up Time* and par. 3-52 *Ramp 2 Ramp Down Time* according to the load inertia before carrying out PID autotuning. If PID autotuning is carried out with slow ramp times, the auto-tuned parameters will typically result in very slow control. Excessive feedback sensor noise should be removed using the input filter (parameter groups 6-*, 5-5* and 26-*, Terminal 53/54 Filter Time Constant/Pulse Filter Time Constant #29/33) before activating PID autotuning. In order to obtain the most accurate controller parameters, it is advised to carry out PID autotuning, when the application is running in typical operation, i.e. with a typical load.

3

20-70 Closed Loop Type

Option:
Function:

This parameter defines the application response. The default mode should be sufficient for most applications. If the application response speed is known, it can be selected here. This will decrease the time needed for carrying out PID autotuning. The setting has no impact on the value of the tuned parameters and is used only for the autotuning sequence.

[0] *	Auto
[1]	Fast Pressure
[2]	Slow Pressure
[3]	Fast Temperature
[4]	Slow Temperature

20-71 PID Performance

Option:
Function:

[0] *	Normal	Normal setting of this parameter will be suitable for pressure control in fan systems.
[1]	Fast	Fast setting would generally be used in pumping systems, where a faster control response is desirable.

20-72 PID Output Change

Range:
Function:

0.10 N/A* [0.01 - 0.50 N/A]

This parameter sets the magnitude of step change during autotuning. The value is a percentage of full speed. I.e. if maximum output frequency in par. 4-13 *Motor Speed High Limit [RPM]* par. 4-14 *Motor Speed High Limit [Hz]* is set to 50Hz, 0.10 is 10% of 50Hz, which is 5Hz. This parameter should be set to a value resulting in feedback changes of between 10% and 20% for best tuning accuracy.

20-73 Minimum Feedback Level

Range:
Function:

-999999.00 [-999999.999 - par. 20-74 Proc-
0 Proc-essCtrlUnit]
essCtrlU-
nit*

The minimum allowable feedback level should be entered here in User units as defined in par. 20-12 *Reference/Feedback Unit*. If the level falls below par. 20-73 *Minimum Feedback Level*, autotuning is aborted and an error message will appear on the LCP.

20-74 Maximum Feedback Level

Range:
Function:

999999.000 [par. 20-73 - 999999.999 Proc-
ProcessCtr- essCtrlUnit]
lUnit*

The maximum allowable feedback level should be entered here in User units as defined in par. 20-12 *Reference/Feedback Unit*. If the level rises above par. 20-74 *Maximum Feedback Level*, autotuning is aborted and an error message will appear on the LCP.

20-79 PID Autotuning

Option:

Function:

This parameter starts the PID autotuning sequence. Once the autotuning has successfully completed and the settings have been accepted or rejected by the user, by pressing [OK] or [Cancel] buttons on the LCP at the end of tuning, this parameter is reset to [0] Disabled.

- [0] * Disabled
- [1] Enabled

3.18.6 20-8* Basic Settings

This parameter group is used to configure the basic operation of the frequency converter's PID Controller, including how it responds to a feedback that is above or below the setpoint, the speed at which it first starts functioning, and when it will indicate that the system has reached the setpoint.

20-81 PID Normal/ Inverse Control

Option:

Function:

- [0] * Normal

Normal [0] causes the frequency converter's output frequency to decrease when the feedback is greater than the setpoint reference. This is common for pressure-controlled supply fan and pump applications.

- [1] Inverse

Inverse [1] causes the frequency converter's output frequency to increase when the feedback is greater than the setpoint reference. This is common for temperature-controlled cooling applications, such as cooling towers.

20-82 PID Start Speed [RPM]

Range:

Function:

- 0 RPM* [0 - par. 4-13 RPM]

When the frequency converter is first started, it initially ramps up to this output speed in Open Loop Mode, following the active Ramp Up Time. When the output speed programmed here is reached, the frequency converter will automatically switch to Closed Loop Mode and the PID Controller will begin to function. This is useful in applications in which the driven load must first quickly accelerate to a minimum speed when it is started.

NB!
This parameter will only be visible if par. 0-02 *Motor Speed Unit* is set to [0], RPM.

20-83 PID Start Speed [Hz]

Range:

Function:

- 0 Hz* [0.0 - par. 4-14 Hz]

When the frequency converter is first started, it initially ramps up to this output frequency in Open Loop Mode, following the active Ramp Up Time. When the output frequency programmed here is reached, the frequency converter will automatically switch to Closed Loop Mode and the PID Controller will begin to function. This is useful in applications in which the driven load must first quickly accelerate to a minimum speed when it is started.

NB!
This parameter will only be visible if par. 0-02 *Motor Speed Unit* is set to [1], Hz.

20-84 On Reference Bandwidth**Range:**

5 %* [0 - 200 %]

Function:

When the difference between the feedback and the setpoint reference is less than the value of this parameter, the frequency converter's display will show "Run on Reference". This status can be communicated externally by programming the function of a digital output for *Run on Reference/No Warning* [8]. In addition, for serial communications, the On Reference status bit of the frequency converter's Status Word will be high (1).

The *On Reference Bandwidth* is calculated as a percentage of the setpoint reference.

3.18.7 20-9* PID Controller

This group provides the ability to manually adjust this PID Controller. By adjusting the PID Controller parameters the control performance may be improved. See section **PID** in the *VLT HVAC Drive Design Guide, MG.11.Bx.yy* for guidelines on adjusting the PID Controller parameters.

20-91 PID Anti Windup**Option:**

[0] Off

Function:

Off[0] The integrator will continue to change value also after output has reached one of the extremes. This can afterwards cause a delay of change of the output of the controller.

[1]* On

On[1] The integrator will be locked if the output of the built in PID controller has reached one of the extremes (min or max value) and therefore not able to add further change to the value of the process parameter controlled. This allows the controller to respond more quickly when it again can control the system.

20-93 PID Proportional Gain**Range:**

0.50 N/A* [0.00 - 10.00 N/A]

Function:

The proportional gain indicates the number of times the error between the set point and the feedback signal is to be applied.

If (Error x Gain) jumps with a value equal to what is set in par. 20-14 *Maximum Reference/Feedb.* the PID controller will try to change the output speed equal to what is set in par. 4-13 *Motor Speed High Limit [RPM]*/par. 4-14 *Motor Speed High Limit [Hz]* but in practice of course limited by this setting. The proportional band (error causing output to change from 0-100%) can be calculated by means of the formula:

$$\left(\frac{1}{\text{Proportional Gain}} \right) \times (\text{Max Reference})$$

NB!

Always set the desired for par. 20-14 *Maximum Reference/Feedb.* before setting the values for the PID controller in par. group 20-9*.

20-94 PID Integral Time**Range:**

20.00 s* [0.01 - 10000.00 s]

Function:

Over time, the integrator accumulates a contribution to the output from the PID controller as long as there is a deviation between the Reference/Setpoint and feedback signals. The contribution is proportional to the size of the deviation. This ensures that the deviation (error) approaches zero. Quick response on any deviation is obtained when the integral time is set to a low value. Setting it too low, however, may cause the control to become unstable.

The value set, is the time needed for the integrator to add the same contribution as the proportional part for a certain deviation.

If the value is set to 10,000, the controller will act as a pure proportional controller with a P-band based on the value set in par. 20-93, *Proportional Gain*. When no deviation is present, the output from the proportional controller will be 0.

20-95 PID Differentiation Time

Range:

0.00 s* [0.00 - 10.00 s]

Function:

The differentiator monitors the rate of change of the feedback. If the feedback is changing quickly, it will adjust the output of the PID Controller to reduce the rate of change of the feedback. Quick PID Controller response is obtained when this value is large. However, if too large of a value is used, the frequency converter's output frequency may become unstable.

Differentiation time is useful in situations where extremely fast frequency converter response and precise speed control are required. It can be difficult to adjust this for proper system control. Differentiation time is not commonly used in VLT HVAC Drive applications. Therefore, it is generally best to leave this parameter at 0 or OFF.

20-96 PID Diff. Gain Limit

Range:

5.0 N/A* [1.0 - 50.0 N/A]

Function:

The differentiator of a PID Controller responds to the rate of change of the feedback. As a result, an abrupt change in the feedback can cause the differentiator to make a very large change in the PID Controller's output. This parameter limits the maximum effect that the PID Controller's differentiator can produce. A smaller value reduces the maximum effect of the PID Controller's differentiator.

This parameter is only active when par. 20-95 *PID Differentiation Time* is not set to OFF (0 s).

3

3.19 Main Menu - Extended Closed Loop - FC 100 - Group 21

3.19.1 21-** Ext. Closed Loop

The FC102 offers 3 Extended Closed Loop PID controllers in addition to the PID Controller. These can be configured independently to control either external actuators (valves, dampers etc.) or be used together with the internal PID Controller to improve the dynamic responses to setpoint changes or load disturbances.

The Extended Closed Loop PID controllers may be interconnected or connected to the PID Closed Loop controller to form a dual loop configuration.

In order to control a modulating device (e.g. a valve motor), this device must be a positioning servo motor with built-in electronics accepting either a 0-10V (signal from Analog I/O card MCB 109) or a 0/4-20 mA (signal from Control Card and/or General Purpose I/O card MCB 101) control signal.

The output function can be programmed in the following parameters:

- Control Card, terminal 42: par. 6-50 *Terminal 42 Output* (setting [113]...[115] or [149]...[151], Ext. Closed Loop 1/2/3)
- General Purpose I/O card MCB 101, terminal X30/8: par. 6-60 *Terminal X30/8 Output*, (setting [113]...[115] or [149]...[151], Ext. Closed Loop 1/2/3)
- Analog I/O card MCB 109, terminal X42/7...11: par. 26-40 *Terminal X42/7 Output*, par. 26-50 *Terminal X42/9 Output*, par. 26-60 *Terminal X42/11 Output* (setting [113]...[115], Ext. Closed Loop 1/2/3)

General Purpose I/O card and Analog I/O card are optional cards.

3.19.2 21-0* Extended CL autotuning

The extended PID Closed Loop PID controllers (*par. 21-**, Ext. Closed Loop*) can each be auto-tuned, simplifying and saving time during commissioning, whilst ensuring accurate PID control adjustment.

To use PID autotuning it is necessary for the relevant Extended PID controller to have been configured for the application.

A graphical Local Control Panel (LCP) must be used in order to react on messages during the autotuning sequence.

Enabling autotuning par. 21-09 *PID Autotuning* puts the relevant PID controller into PID autotuning mode. The LCP then directs the user with on-screen instructions.

PID autotuning functions by introducing step changes and then monitoring the feedback. From the feedback response, the required values for PID Proportional Gain, par. 21-21 *Ext. 1 Proportional Gain* for EXT CL 1, par. 21-41 *Ext. 2 Proportional Gain* for EXT CL 2 and par. 21-61 *Ext. 3 Proportional Gain* for EXT CL 3 and Integral Time, par. 21-22 *Ext. 1 Integral Time* for EXT CL 1, par. 21-42 *Ext. 2 Integral Time* for EXT CL 2 and par. 21-62 *Ext. 3 Integral Time* for EXT CL 3 are calculated. PID Differentiation Time, par. 21-23 *Ext. 1 Differentiation Time* for EXT CL 1, par. 21-43 *Ext. 2 Differentiation Time* for EXT CL 2 and par. 21-63 *Ext. 3 Differentiation Time* for EXT CL 3 are set to value 0 (zero). Normal / Inverse, par. 21-20 *Ext. 1 Normal/Inverse Control* for EXT CL 1, par. 21-40 *Ext. 2 Normal/Inverse Control* for EXT CL 2 and par. 21-60 *Ext. 3 Normal/Inverse Control* for EXT CL 3 are determined during the tuning process.

These calculated values are presented on the LCP and the user can decide whether to accept or reject them. Once accepted, the values are written to the relevant parameters and PID autotuning mode is disabled in par. 21-09 *PID Autotuning*. Depending on the system being controlled the time required to carry out PID autotuning could be several minutes.

Excessive feedback sensor noise should be removed using the input filter (parameter groups 6*,5.5* and 26*, Terminal 53/54 Filter Time Constant/Pulse Filter Time Constant #29/33) before activating PID autotuning.

21-00 Closed Loop Type

Option:
Function:

This parameter defines the application response. The default mode should be sufficient for most applications. If the relative application speed is known, it can be selected here. This will decrease the time needed for carrying out PID Autotuning. The setting has no impact on the value of the tuned parameters and is used only for the PID auto-tuning sequence.

[0] *	Auto
[1]	Fast Pressure
[2]	Slow Pressure
[3]	Fast Temperature
[4]	Slow Temperature

21-01 PID Performance

Option:
Function:

[0] *	Normal	Normal setting of this parameter will be suitable for pressure control in fan systems.
[1]	Fast	Fast setting would generally be used in pumping systems, where a faster control response is desirable.

21-02 PID Output Change

Range:
Function:

0.10 N/A* [0.01 - 0.50 N/A]	This parameter sets the magnitude of step change during auto tuning. The value is a percentage of full operating range. I.e. if maximum analog output voltage is set to 10 V, 0.10 is 10% of 10 V, which is 1 V. This parameter should be set to a value resulting in feedback changes of between 10% and 20% for best tuning accuracy.
-----------------------------	---

21-03 Minimum Feedback Level

Range:
Function:

-999999.00 [-999999.999 - par. 21-04 N/A] 0 N/A*	The minimum allowable feedback level should be entered here in User Units as defined in par. 21-10 <i>Ext. 1 Ref./Feedback Unit</i> for EXT CL 1, par. 21-30 <i>Ext. 2 Ref./Feedback Unit</i> for EXT CL 2 or par. 21-50 <i>Ext. 3 Ref./Feedback Unit</i> for EXT CL 3. If the level falls below par. 21-03 <i>Minimum Feedback Level</i> , PID autotuning is aborted and an error message will appear on the LCP.
---	--

21-04 Maximum Feedback Level

Range:
Function:

999999.000 [par. 21-03 - 999999.999 N/A] N/A*	The maximum allowable feedback level should be entered here in User units as defined in par. 21-10 <i>Ext. 1 Ref./Feedback Unit</i> for EXT CL 1, par. 21-30 <i>Ext. 2 Ref./Feedback Unit</i> for EXT CL 2 or par. 21-50 <i>Ext. 3 Ref./Feedback Unit</i> for EXT CL 3. If the level rises above par. 21-04 <i>Maximum Feedback Level</i> , PID autotuning is aborted and an error message will appear on the LCP.
--	--

21-09 PID Autotuning

Option:

Function:

This parameter enables selection of the Extended PID controller to be Auto-tuned and starts the PID autotuning for that controller. Once the autotuning has successfully completed and the settings have been accepted or rejected by the user, by pressing [OK] or [Cancel] buttons on the LCP at the end of tuning, this parameter is reset to [0] Disabled.

- [0] * Disabled
- [1] Enabled Ext CL 1 PID
- [2] Enabled Ext CL 2 PID
- [3] Enabled Ext CL 3 PID

3.19.3 21-1* Closed Loop 1 Ref/Feedback

Configure Extended Closed Loop 1 Controller reference and feedback.

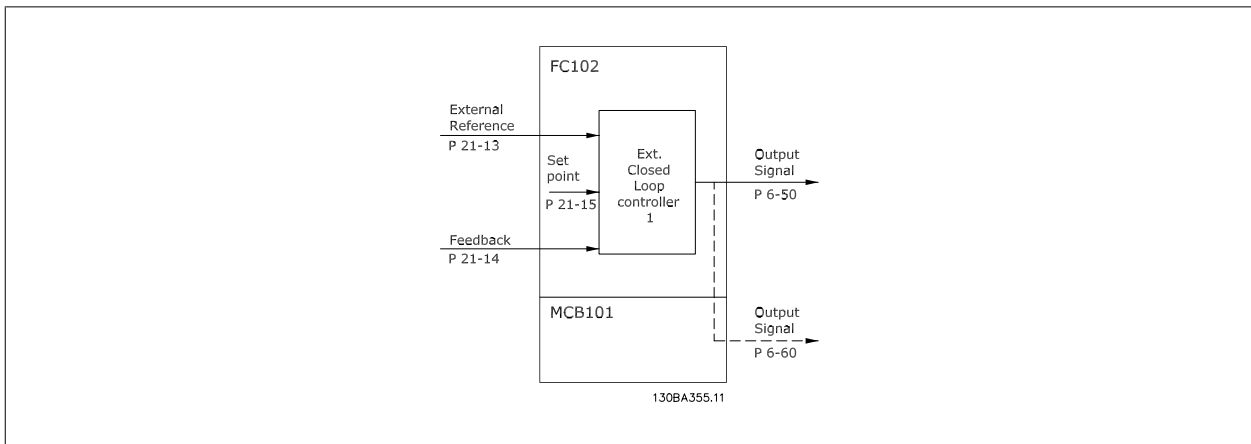

21-10 Ext. 1 Ref./Feedback Unit

Option:

Function:

Select the unit for the reference and feedback.

- [0]
- [1] * %
- [5] PPM
- [10] 1/min
- [11] RPM
- [12] Pulse/s
- [20] l/s
- [21] l/min
- [22] l/h
- [23] m³/s
- [24] m³/min
- [25] m³/h
- [30] kg/s
- [31] kg/min
- [32] kg/h
- [33] t/min
- [34] t/h

[40]	m/s
[41]	m/min
[45]	m
[60]	°C
[70]	mbar
[71]	bar
[72]	Pa
[73]	kPa
[74]	m WG
[75]	mm Hg
[80]	kW
[120]	GPM
[121]	gal/s
[122]	gal/min
[123]	gal/h
[124]	CFM
[125]	ft ³ /s
[126]	ft ³ /min
[127]	ft ³ /h
[130]	lb/s
[131]	lb/min
[132]	lb/h
[140]	ft/s
[141]	ft/min
[145]	ft
[160]	°F
[170]	psi
[171]	lb/in ²
[172]	in WG
[173]	ft WG
[174]	in Hg
[180]	HP

21-11 Ext. 1 Minimum Reference

Range:

0.000 Ex- [-999999.999 - par. 21-12 Ex- tPID1Unit* tPID1Unit]

Function:

Select the minimum for the Closed Loop 1 Controller.

21-12 Ext. 1 Maximum Reference

Range:

100.000 Ex- [par. 21-11 - 999999.999 Ex- tPID1Unit* tPID1Unit]

Function:

Select the maximum for the Closed Loop 1 Controller.

The dynamics of the PID controller will depend on the value set in this parameter. Please see also par. 21-21, *Ext. 1 Proportional Gain*.

NB!

Always set the desired value for par. 21-12, *Maximum Reference* before setting the values for the PID controller in par. 20-9*.

21-13 Ext. 1 Reference Source

Option:

Function:

This parameter defines which input on the frequency converter should be treated as the source of the reference signal for the Closed Loop 1 Controller. Analog input X30/11 and Analog input X30/12 refer to inputs on the General Purpose I/O.

[0] * No function

[1] Analog input 53

[2] Analog input 54

[7] Pulse input 29

[8] Pulse input 33

[20] Digital pot.meter

[21] Analog input X30/11

[22] Analog input X30/12

[23] Analog Input X42/1

[24] Analog Input X42/3

[25] Analog Input X42/5

[30] Ext. Closed Loop 1

[31] Ext. Closed Loop 2

[32] Ext. Closed Loop 3

21-14 Ext. 1 Feedback Source

Option:

Function:

This parameter defines which input on the frequency converter should be treated as the source of the feedback signal for the Closed Loop 1 controller. Analog input X30/11 and Analog input X30/12 refer to inputs on the General Purpose I/O .

[0] * No function

[1] Analog input 53

[2] Analog input 54

[3] Pulse input 29

[4] Pulse input 33

[7] Analog input X30/11

[8] Analog input X30/12

[9] Analog Input X42/1

[10] Analog Input X42/3

[11] Analog Input X42/5

[100] Bus feedback 1

[101] Bus feedback 2

[102] Bus feedback 3

21-15 Ext. 1 Setpoint

Range:

Function:

0.000 Ex- [par. 21-11 - par. 21-12 Ex- tPID1Unit* tPID1Unit]

The setpoint reference is used in extended 1 closed loop. Ext.1 Setpoint is added to the value from the Ext.1 Reference source selected in par. 21-13 *Ext. 1 Reference Source*.

21-17 Ext. 1 Reference [Unit]

Range:

Function:

0.000 Ex- [-999999.999 - 999999.999 Ex- tPID1Unit* tPID1Unit]

Readout of the reference value for the Closed Loop 1 Controller.

21-18 Ext. 1 Feedback [Unit]

Range:

0.000 Ex- [-999999.999 - 999999.999 Ex- tPID1Unit* tPID1Unit]

Function:

Readout of the feedback value for the Closed Loop 1 Controller.

21-19 Ext. 1 Output [%]

Range:

0 %* [0 - 100 %]

Function:

Readout of the output value for the Closed Loop 1 Controller.

3.19.4 21-2* Closed Loop 1 PID

Configure the Closed Loop 1 PID controller.

21-20 Ext. 1 Normal/Inverse Control

Option:

[0] * Normal

Function:Select *Normal* [0] if the output should be reduced when feedback is higher than the reference.

[1] Inverse

Select *Inverse* [1] if the output should be increased when feedback is higher than the reference.

21-21 Ext. 1 Proportional Gain

Range:

0.01 N/A* [0.00 - 10.00 N/A]

Function:

The proportional gain indicates the number of times the error between the set point and the feedback signal is to be applied.

If (Error x Gain) jumps with a value equal to what is set in par. 20-14, *Maximum Reference/Feedback*, the PID controller will try to change the output speed equal to what is set in par. 4-13/4-14, Motor Speed High Limit, but in practice of course limited by this setting.

The proportional band (error causing output to change from 0-100%) can be calculated by means of the formula:

$$\left(\frac{1}{\text{Proportional Gain}} \right) \times (\text{Max Reference})$$

NB!

Always set the desired for par. 20-14, *Maximum Reference/Feedback* before setting the values for the PID controller in par. group 20-9*.

21-22 Ext. 1 Integral Time

Range:10000.00 [0.01 - 10000.00 s]
s***Function:**

Over time, the integrator accumulates a contribution to the output from the PID controller as long as there is a deviation between the Reference/Setpoint and feedback signals. The contribution is proportional to the size of the deviation. This ensures that the deviation (error) approaches zero. Quick response on any deviation is obtained when the integral time is set to a low value. Setting it too low, however, may cause the control to become unstable.

The value set, is the time needed for the integrator to add the same contribution as the proportional part for a certain deviation.

If the value is set to 10,000, the controller will act as a pure proportional controller with a P-band based on the value set in par. 20-93, *Proportional Gain*. When no deviation is present, the output from the proportional controller will be 0.

21-23 Ext. 1 Differentiation Time

Range:

0.00 s* [0.00 - 10.00 s]

Function:

The differentiator does not react to a constant error. It only provides a gain when the feedback changes. The quicker the feedback changes, the stronger the gain from the differentiator.

21-24 Ext. 1 Dif. Gain Limit

Range:

5.0 N/A* [1.0 - 50.0 N/A]

Function:

Set a limit for the differentiator gain (DG). The DG will increase if there are fast changes. Limit the DG to obtain a pure differentiator gain at slow changes and a constant differentiator gain where quick changes occur.

3.19.5 21-3* Closed Loop 2 Ref/Fb

Configure Extended Closed Loop 2 Controller reference and feedback.

21-30 Ext. 2 Ref./Feedback Unit

Option:

Function:

See par. 21-10 *Ext. 1 Ref./Feedback Unit* for details

[0]

[1] * %

[5] PPM

[10] 1/min

[11] RPM

[12] Pulse/s

[20] l/s

[21] l/min

[22] l/h

[23] m³/s

[24] m³/min

[25] m³/h

[30] kg/s

[31] kg/min

[32] kg/h

[33] t/min

[34] t/h

[40] m/s

[41] m/min

[45] m

[60] °C

[70] mbar

[71] bar

[72] Pa

[73] kPa

[74] m WG

[75] mm Hg

[80] kW

[120] GPM

[121] gal/s

[122] gal/min

[123] gal/h

[124] CFM

[125] ft³/s

[126]	ft ³ /min
[127]	ft ³ /h
[130]	lb/s
[131]	lb/min
[132]	lb/h
[140]	ft/s
[141]	ft/min
[145]	ft
[160]	°F
[170]	psi
[171]	lb/in ²
[172]	in WG
[173]	ft WG
[174]	in Hg
[180]	HP

21-31 Ext. 2 Minimum Reference**Range:**

0.000 Ex- [-999999.999 - par. 21-32 Ex- tPID2Unit* tPID2Unit]

Function:

See par. 21-11 *Ext. 1 Minimum Reference* for details.

21-32 Ext. 2 Maximum Reference**Range:**

100.000 Ex- [par. 21-31 - 999999.999 Ex- tPID2Unit* tPID2Unit]

Function:

See par. 21-12 *Ext. 1 Maximum Reference* for details.

21-33 Ext. 2 Reference Source**Option:**

See par. 21-13 *Ext. 1 Reference Source* for details.

Function:

[0] *	No function
[1]	Analog input 53
[2]	Analog input 54
[7]	Pulse input 29
[8]	Pulse input 33
[20]	Digital pot.meter
[21]	Analog input X30/11
[22]	Analog input X30/12
[23]	Analog Input X42/1
[24]	Analog Input X42/3
[25]	Analog Input X42/5
[30]	Ext. Closed Loop 1
[31]	Ext. Closed Loop 2
[32]	Ext. Closed Loop 3

21-34 Ext. 2 Feedback Source

Option:

Function:

See par. 21-14 *Ext. 1 Feedback Source* for details.

[0] * No function

[1] Analog input 53

[2] Analog input 54

[3] Pulse input 29

[4] Pulse input 33

[7] Analog input X30/11

[8] Analog input X30/12

[9] Analog Input X42/1

[10] Analog Input X42/3

[11] Analog Input X42/5

[100] Bus feedback 1

[101] Bus feedback 2

[102] Bus feedback 3

21-35 Ext. 2 Setpoint

Range:

Function:

0.000 Ex- [par. 21-31 - par. 21-32 Ex- See par. 21-15 *Ext. 1 Setpoint* for details.
tPID2Unit* tPID2Unit]

21-37 Ext. 2 Reference [Unit]

Range:

Function:

0.000 Ex- [-999999.999 - 999999.999 See par. 21-17 *Ext. 1 Reference [Unit]*, *Ext. 1 Reference [Unit]*, for details.
tPID2Unit* ExtPID2Unit]

21-38 Ext. 2 Feedback [Unit]

Range:

Function:

0.000 Ex- [-999999.999 - 999999.999 See par. 21-18 *Ext. 1 Feedback [Unit]* for details.
tPID2Unit* ExtPID2Unit]

21-39 Ext. 2 Output [%]

Range:

Function:

0 %* [0 - 100 %] See par. 21-19 *Ext. 1 Output [%]* for details.

3.19.6 21-4* Closed Loop 2 PID

Configure the Closed Loop 2 PID Controller.

21-40 Ext. 2 Normal/Inverse Control

Option:

Function:

See par. 21-20 *Ext. 1 Normal/Inverse Control* for details.

[0] * Normal

[1] Inverse

21-41 Ext. 2 Proportional Gain

Range:

Function:

0.01 N/A* [0.00 - 10.00 N/A] See par. 21-21 *Ext. 1 Proportional Gain* for details.

21-42 Ext. 2 Integral Time**Range:**10000.00 [0.01 - 10000.00 s]
s***Function:**See par. 21-22 *Ext. 1 Integral Time* for details.**21-43 Ext. 2 Differentiation Time****Range:**

0.00 s* [0.00 - 10.00 s]

Function:See par. 21-23 *Ext. 1 Differentiation Time* for details.**21-44 Ext. 2 Dif. Gain Limit****Range:**

5.0 N/A* [1.0 - 50.0 N/A]

Function:See par. 21-24 *Ext. 1 Dif. Gain Limit* for details.**3.19.7 21-5* Closed Loop 3 Ref/Fb**

Configure Extended Closed Loop 3 Controller reference and feedback.

21-50 Ext. 3 Ref./Feedback Unit**Option:****Function:**See par. 21-10 *Ext. 1 Ref./Feedback Unit* for details.

[0]

[1] * %

[5] PPM

[10] 1/min

[11] RPM

[12] Pulse/s

[20] l/s

[21] l/min

[22] l/h

[23] m³/s[24] m³/min[25] m³/h

[30] kg/s

[31] kg/min

[32] kg/h

[33] t/min

[34] t/h

[40] m/s

[41] m/min

[45] m

[60] °C

[70] mbar

[71] bar

[72] Pa

[73] kPa

[74] m WG

[75] mm Hg

[80] kW

- [120] GPM
- [121] gal/s
- [122] gal/min
- [123] gal/h
- [124] CFM
- [125] ft³/s
- [126] ft³/min
- [127] ft³/h
- [130] lb/s
- [131] lb/min
- [132] lb/h
- [140] ft/s
- [141] ft/min
- [145] ft
- [160] °F
- [170] psi
- [171] lb/in²
- [172] in WG
- [173] ft WG
- [174] in Hg
- [180] HP

21-51 Ext. 3 Minimum Reference

Range: 0.000 Ex- [-999999.999 - par. 21-52 Ex- tPID3Unit* tPID3Unit]
Function: See par. 21-11 *Ext. 1 Minimum Reference* for details.

21-52 Ext. 3 Maximum Reference

Range: 100.000 Ex- [par. 21-51 - 999999.999 Ex- tPID3Unit* tPID3Unit]
Function: See par. 21-12 *Ext. 1 Maximum Reference* for details.

21-53 Ext. 3 Reference Source

Option:
Function: See par. 21-13 *Ext. 1 Reference Source* for details.

- [0] * No function
- [1] Analog input 53
- [2] Analog input 54
- [7] Pulse input 29
- [8] Pulse input 33
- [20] Digital pot.meter
- [21] Analog input X30/11
- [22] Analog input X30/12
- [23] Analog Input X42/1
- [24] Analog Input X42/3
- [25] Analog Input X42/5
- [30] Ext. Closed Loop 1
- [31] Ext. Closed Loop 2
- [32] Ext. Closed Loop 3

21-54 Ext. 3 Feedback Source**Option:****Function:**See par. 21-14 *Ext. 1 Feedback Source* for details.

[0] *	No function
[1]	Analog input 53
[2]	Analog input 54
[3]	Pulse input 29
[4]	Pulse input 33
[7]	Analog input X30/11
[8]	Analog input X30/12
[9]	Analog Input X42/1
[10]	Analog Input X42/3
[11]	Analog Input X42/5
[100]	Bus feedback 1
[101]	Bus feedback 2
[102]	Bus feedback 3

21-55 Ext. 3 Setpoint**Range:****Function:**0.000 Ex- [par. 21-51 - par. 21-52 Ex- tPID3Unit* tPID3Unit] See par. 21-15 *Ext. 1 Setpoint* for details.**21-57 Ext. 3 Reference [Unit]****Range:****Function:**0.000 Ex- [-999999.999 - 999999.999 tPID3Unit* ExtPID3Unit] See par. 21-17 *Ext. 1 Reference [Unit]* for details.**21-58 Ext. 3 Feedback [Unit]****Range:****Function:**0.000 Ex- [-999999.999 - 999999.999 tPID3Unit* ExtPID3Unit] See par. 21-18 *Ext. 1 Feedback [Unit]* for details.**21-59 Ext. 3 Output [%]****Range:****Function:**0 %* [0 - 100 %] See par. 21-19 *Ext. 1 Output [%]* for details.**3.19.8 21-6* Closed Loop 3 PID**

Configure the Closed Loop 3 PID Controller.

21-60 Ext. 3 Normal/Inverse Control**Option:****Function:**See par. 21-20 *Ext. 1 Normal/Inverse Control* for details.

[0] *	Normal
[1]	Inverse

21-61 Ext. 3 Proportional Gain**Range:****Function:**0.01 N/A* [0.00 - 10.00 N/A] See par. 21-21 *Ext. 1 Proportional Gain* for details.

21-62 Ext. 3 Integral Time

Range:	Function:
10000.00 [0.01 - 10000.00 s] s*	See par. 21-22 <i>Ext. 1 Integral Time</i> for details.

21-63 Ext. 3 Differentiation Time

Range:	Function:
0.00 s* [0.00 - 10.00 s]	See par. 21-23 <i>Ext. 1 Differentiation Time</i> for details.

21-64 Ext. 3 Dif. Gain Limit

Range:	Function:
5.0 N/A* [1.0 - 50.0 N/A]	See par. 21-24 <i>Ext. 1 Dif. Gain Limit</i> for details.

3.20 Main Menu - Application Functions - FC 100 - Group 22

This group contains parameters used for monitoring VLT HVAC Drive applications.

22-00 External Interlock Delay

Range:	Function:
0 s* [0 - 600 s]	Only relevant if one of the digital inputs in par. 5-1* has been programmed for <i>External Interlock</i> [7]. The External Interlock Timer will introduce a delay after the signal has been removed from the digital input programmed for External Interlock, before reaction takes place.

3.20.1 22-2* No-Flow Detection

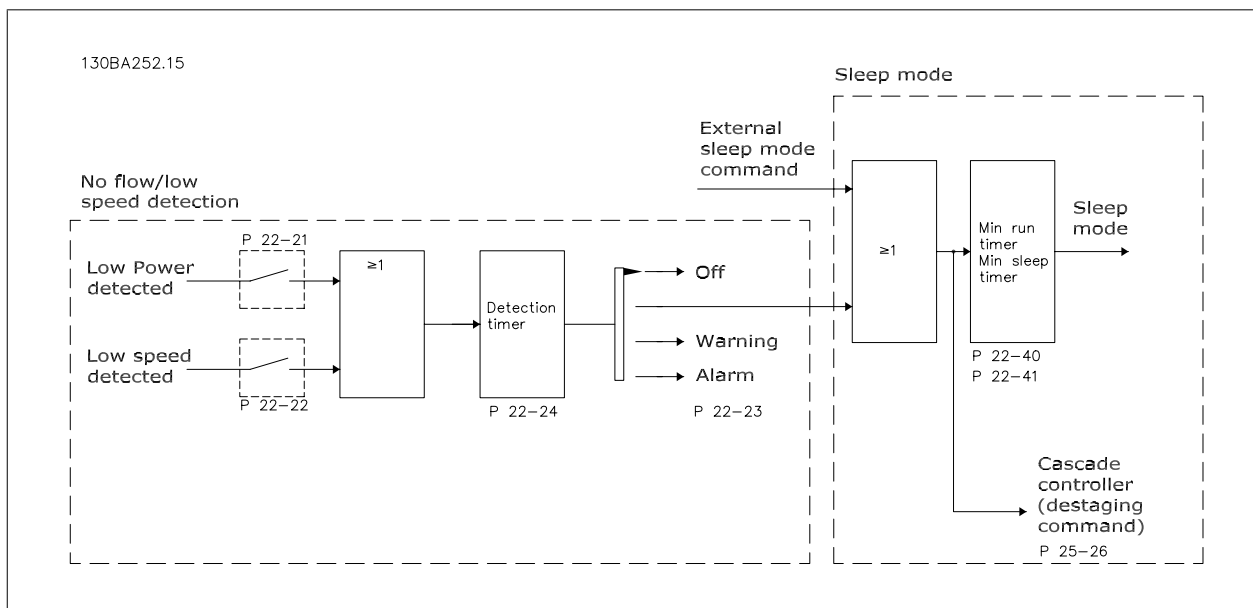

The frequency converter includes functions for detecting if the load conditions in the system allow the motor to be stopped:

*Low Power Detection

*Low Speed Detection

One of these two signals must be active for a set time (par. 22-24 *No-Flow Delay*) before selected action takes place. Possible actions to select (par. 22-23 *No-Flow Function*): No action, Warning, Alarm, Sleep Mode.

No Flow Detection:

This function is used for detecting a no flow situation in pump systems where all valves can be closed. Can be used both when controlled by the integrated PI controller in the frequency converter or an external PI controller. Actual configuration must be programmed in par. 1-00 *Configuration Mode*.

Configuration mode for

- Integrated PI Controller: Closed Loop
- External PI Controller: Open Loop



Carry out No Flow tuning before setting the PI controller parameters!

3

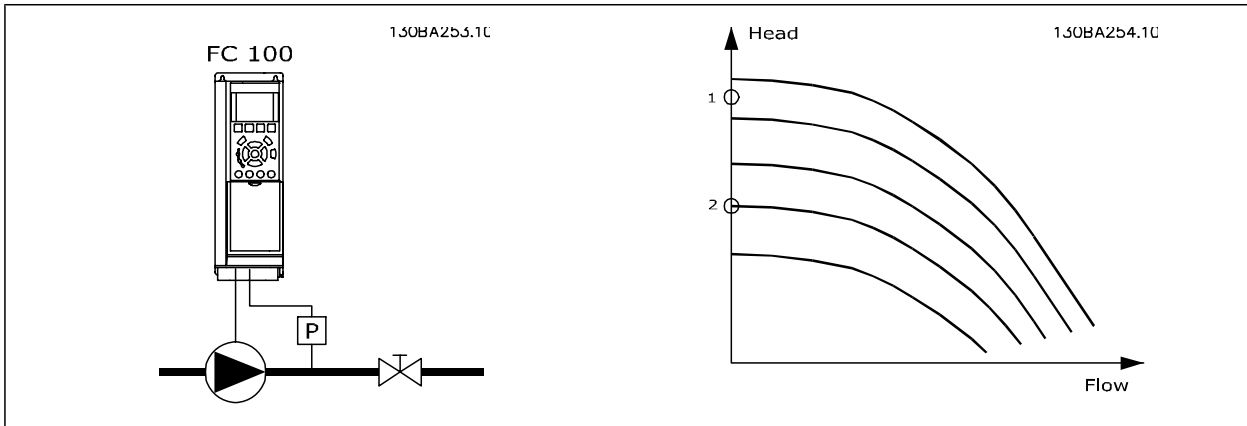

No Flow Detection is based on the measurement of speed and power. For a certain speed the frequency converter calculates the power at no flow. This coherence is based on the adjustment of two sets of speed and associated power at no flow. By monitoring the power it is possible to detect no flow conditions in systems with fluctuating suction pressure or if the pump has a flat characteristic towards low speed. The two sets of data must be based on measurement of power at approx. 50% and 85% of maximum speed with the valve(s) closed. The data are programmed in the par. 22-3*. It is also possible to run a *Low Power Auto Set Up* (par. 22-20 *Low Power Auto Set-up*), automatically stepping through the commissioning process and also automatically storing the data measured. The frequency converter must be set for Open Loop in par. 1-00 *Configuration Mode*, when carrying out the Auto Set Up (See No Flow Tuning par. 22-3*).



If to use the integrated PI controller, carry out No Flow tuning before setting the PI controller parameters!

Low speed detection:

Low Speed Detection gives a signal if the motor is operating with minimum speed as set in par. 4-11 *Motor Speed Low Limit [RPM]* or par. 4-12 *Motor Speed Low Limit [Hz]*. Actions are common with No Flow Detection (individual selection not possible).

The use of Low Speed Detection is not limited to systems with a no flow situation, but can be used in any system where operation at minimum speed allows for a stop of the motor until the load calls for a speed higher than minimum speed, e.g. systems with fans and compressors.



In pump systems ensure that the minimum speed in par. 4-11 *Motor Speed Low Limit [RPM]* or par. 4-12 *Motor Speed Low Limit [Hz]* has been set high enough for detection as the pump can run with a rather high speed even with valves closed.

Dry pump detection:

No Flow Detection can also be used for detecting if the pump has run dry (low power consumption-high speed). Can be used with both the integrated PI controller and an external PI controller.

The condition for Dry Pump signal:

- Power consumption below no flow level

and

- Pump running at maximum speed or maximum reference open loop, whichever is lowest.

The signal must be active for a set time (par. 22-27 *Dry Pump Delay*) before selected the action takes place.

Possible Actions to select (par. 22-26 *Dry Pump Function*):

- Warning
- Alarm

No Flow Detection must be enabled (par. 22-23 *No-Flow Function*) and commissioned (par. 22-3*, *No Power Tuning*).

22-20 Low Power Auto Set-up

Option:

Function:

When set for *Enabled*, an auto set up sequence is activated, automatically setting speed to approx. 50 and 85% of rated motor speed (par. 4-13 *Motor Speed High Limit [RPM]*, par. 4-14 *Motor Speed High Limit [Hz]*). At those two speeds, the power consumption is automatically measured and stored. Before enabling Auto Set Up:

1. Close valve(s) in order to create a no flow condition
2. The frequency converter must be set for Open Loop (par. 1-00 *Configuration Mode*). Note that it is important also to set par. 1-03 *Torque Characteristics*.

[0] * Off

[1] Enabled



NB!

Auto Set Up must be done when the system has reached normal operating temperature!



NB!

It is important that the par. 4-13 *Motor Speed High Limit [RPM]* or par. 4-14 *Motor Speed High Limit [Hz]* is set to the max. operational speed of the motor!
It is important to do the Auto Set-up before configuring the integrated PI Controller as settings will be reset when changing from Closed to Open Loop in par. 1-00 *Configuration Mode*.



NB!

Carry out the tuning with the same settings in par. 1-03 *Torque Characteristics*, as for operation after the tuning.

22-21 Low Power Detection

Option:

Function:

[0] * Disabled

[1] Enabled

If selecting Enabled, the Low Power Detection commissioning must be carried out in order to set the parameters in group 22-3* for proper operation!

22-22 Low Speed Detection

Option:

Function:

[0] * Disabled

[1] Enabled

Select Enabled for detecting when the motor operates with a speed as set in par. 4-11 *Motor Speed Low Limit [RPM]* or par. 4-12 *Motor Speed Low Limit [Hz]*.

22-23 No-Flow Function

Option:
Function:

Common actions for Low Power Detection and Low Speed Detection (Individual selections not possible).

[0] * Off

[1] Sleep Mode

[2] Warning Messages in the Local Control Panel display (if mounted) and/or signal via a relay or a digital output.

[3] Alarm The frequency converter trips and motor stays stopped until reset.

22-24 No-Flow Delay

Range:
Function:

10 s* [1 - 600 s]

Set the time Low Power/Low Speed must stay detected to activate signal for actions. If detection disappears before run out of the timer, the timer will be reset.

22-26 Dry Pump Function

Option:
Function:

Low Power Detection must be Enabled (par. 22-21 *Low Power Detection*) and commissioned (using either par. 22-3*, *No Flow Power Tuning*, or par. 22-20 *Low Power Auto Set-up*) in order to use Dry Pump Detection.

[0] * Off

[1] Warning Messages in the Local Control Panel display (if mounted) and/or signal via a relay or a digital output.

[2] Alarm The frequency converter trips and motor stays stopped until reset.

22-27 Dry Pump Delay

Range:
Function:

10 s* [0 - 600 s]

Defines for how long the Dry Pump condition must be active before activating Warning or Alarm

3.20.2 No-Flow Power Tuning, 22-3*

Tuning Sequence, if not choosing *Auto Set Up* in par. 22-20 *Low Power Auto Set-up*:

1. Close the main valve to stop flow
2. Run with motor until the system has reached normal operating temperature
3. Press Hand On button on the Local Control Panel and adjust speed for approx. 85% of rated speed. Note the exact speed
4. Read power consumption either by looking for actual power in the data line in the Local Control Panel or call par. 16-10 *Power [kW]* or par. 16-11 *Power [hp]* in Main Menu. Note the power read out
5. Change speed to approx. 50% of rated speed. Note the exact speed
6. Read power consumption either by looking for actual power in the data line in the Local Control Panel or call par. 16-10 *Power [kW]* or par. 16-11 *Power [hp]* in Main Menu. Note the power read
7. Program the speeds used in par. 22-32 *Low Speed [RPM]*, par. 22-33 *Low Speed [Hz]*, par. 22-36 *High Speed [RPM]* and par. 22-37 *High Speed [Hz]*
8. Program the associated power values in par. 22-34 *Low Speed Power [kW]*, par. 22-35 *Low Speed Power [HP]*, par. 22-38 *High Speed Power [kW]* and par. 22-39 *High Speed Power [HP]*
9. Switch back by means of *Auto On* or *Off*

NB!

Set par. 1-03 *Torque Characteristics* before tuning takes place.

22-30 No-Flow Power

Range:	Function:
0.00 kW* [0.00 - 0.00 kW]	Read out of calculated No Flow power at actual speed. If power drops to the display value the frequency converter will consider the condition as a No Flow situation.

22-31 Power Correction Factor

Range:	Function:
100 %* [1 - 400 %]	Make corrections to the calculated power at par. 22-30 <i>No-Flow Power</i> . If No Flow is detected, when it should not be detected, the setting should be decreased. However, if No Flow is not detected, when it should be detected, the setting should be increased to above 100%.

22-32 Low Speed [RPM]

Range:	Function:
0 RPM* [0 - par. 22-36 RPM]	To be used if par. 0-02 <i>Motor Speed Unit</i> has been set for RPM (parameter not visible if Hz selected). Set used speed for the 50% level. This function is used for storing values needed to tune No Flow Detection.

22-33 Low Speed [Hz]

Range:	Function:
0 Hz* [0.0 - par. 22-37 Hz]	To be used if par. 0-02 <i>Motor Speed Unit</i> has been set for Hz (parameter not visible if RPM selected). Set used speed for the 50% level. The function is used for storing values needed to tune No Flow Detection.

22-34 Low Speed Power [kW]

Range:	Function:
0 kW* [0.00 - 0.00 kW]	To be used if par. 0-03 <i>Regional Settings</i> has been set for International (parameter not visible if North America selected). Set power consumption at 50% speed level. This function is used for storing values needed to tune No Flow Detection.

22-35 Low Speed Power [HP]

Range:	Function:
0 hp* [0.00 - 0.00 hp]	To be used if par. 0-03 <i>Regional Settings</i> has been set for North America (parameter not visible if International selected). Set power consumption at 50% speed level. This function is used for storing values needed to tune No Flow Detection.

22-36 High Speed [RPM]

Range:	Function:
0 RPM* [0 - par. 4-13 RPM]	To be used if par. 0-02 <i>Motor Speed Unit</i> has been set for RPM (parameter not visible if Hz selected). Set used speed for the 85% level. The function is used for storing values needed to tune No Flow Detection.

22-37 High Speed [Hz]

Range:	Function:
0.0 Hz* [0.0 - par. 4-14 Hz]	To be used if par. 0-02 <i>Motor Speed Unit</i> has been set for Hz (parameter not visible if RPM selected). Set used speed for the 85% level. The function is used for storing values needed to tune No Flow Detection.

22-38 High Speed Power [kW]

Range:

0 kW* [0.00 - 0.00 kW]

Function:

To be used if par. 0-03 *Regional Settings* has been set for International (parameter not visible if North America selected).

Set power consumption at 85% speed level.

This function is used for storing values needed to tune No Flow Detection.

3

22-39 High Speed Power [HP]

Range:

0 hp* [0.00 - 0.00 hp]

Function:

To be used if par. 0-03 *Regional Settings* has been set for North America (parameter not visible if International selected).

Set power consumption at 85% speed level.

This function is used for storing values needed to tune No Flow Detection.

3.20.3 22-4* Sleep Mode

If the load on the system allows for stop of the motor and the load is monitored, the motor can be stopped by activating the Sleep Mode function. This is not a normal Stop command, but ramps the motor down to 0 RPM and stops energizing the motor. When in Sleep Mode certain conditions are monitored to find out when load has been applied to the system again.

Sleep Mode can be activated either from the No Flow Detection/Minimum Speed Detection (must be programmed via parameters for No-Flow Detection, see the signal flow-diagram in parameter group 22-2*, No-Flow Detection) or via an external signal applied to one of the digital inputs (must be programmed via the parameters for configuration of the digital inputs, par.5-1* selecting [66] Sleep Mode). Sleep mode is activated only when no wake-up conditions are present.

To make it possible to use e.g. an electro-mechanical flow switch to detect a no flow condition and activate Sleep Mode, the action takes place at raising edge of the external signal applied (otherwise the frequency converter would never come out of Sleep Mode again as the signal would be steady connected).

NB!

If Sleep Mode is to be based on No Flow Detection/Minimum Speed, remember to choose Sleep Mode [1] in par. 22-23 *No-Flow Function*.

If par. 25-26 *Destage At No-Flow* is set for Enabled, activating Sleep Mode will send a command to the cascade controller (if enabled) to start de-staging of lag pumps (fixed speed) before stopping the lead pump (variable speed).

When entering Sleep Mode, the lower status line in the Local Control Panel shows Sleep Mode.

See also signal flow chart in section 22-2* *No Flow Detection*.

There are three different ways of using the Sleep Mode function:

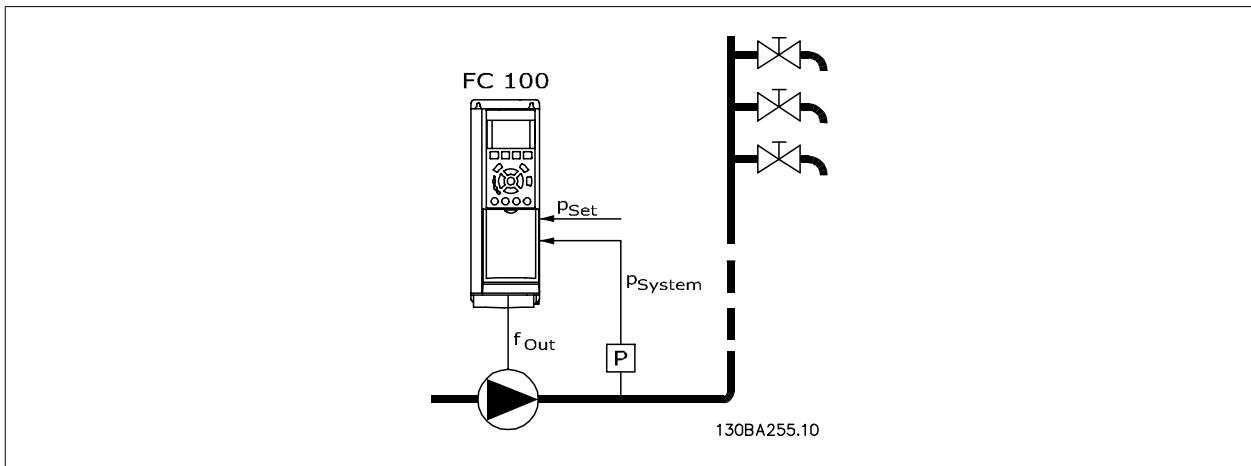

1) Systems where the integrated PI controller is used for controlling pressure or temperature e.g. boost systems with a pressure feed back signal applied to the frequency converter from a pressure transducer. par. 1-00 *Configuration Mode* must be set for Closed Loop and the PI Controller configured for desired reference and feed back signals.

Example: Boost system.

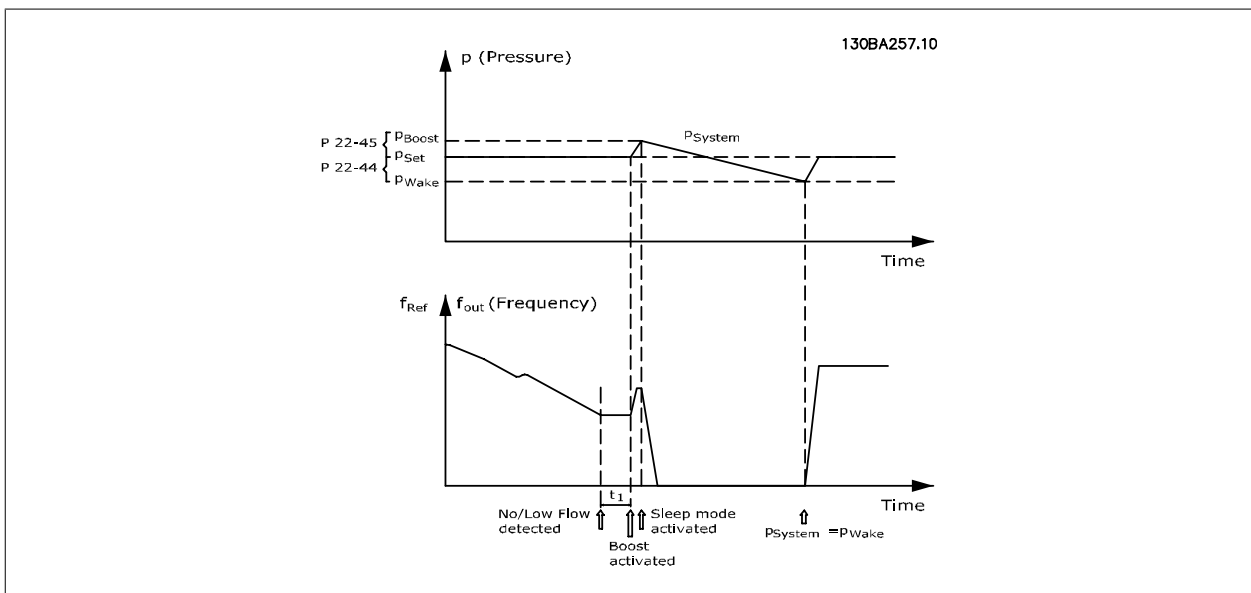

If no flow is detected, the frequency converter will increase the set point for pressure to ensure a slight over pressure in the system (boost to be set in par. 22-45 *Setpoint Boost*).

The feedback from the pressure transducer is monitored and when this pressure has dropped with a set percentage below the normal set point for pressure (Pset), the motor will ramp up again and pressure will be controlled for reaching the set value (Pset).

3

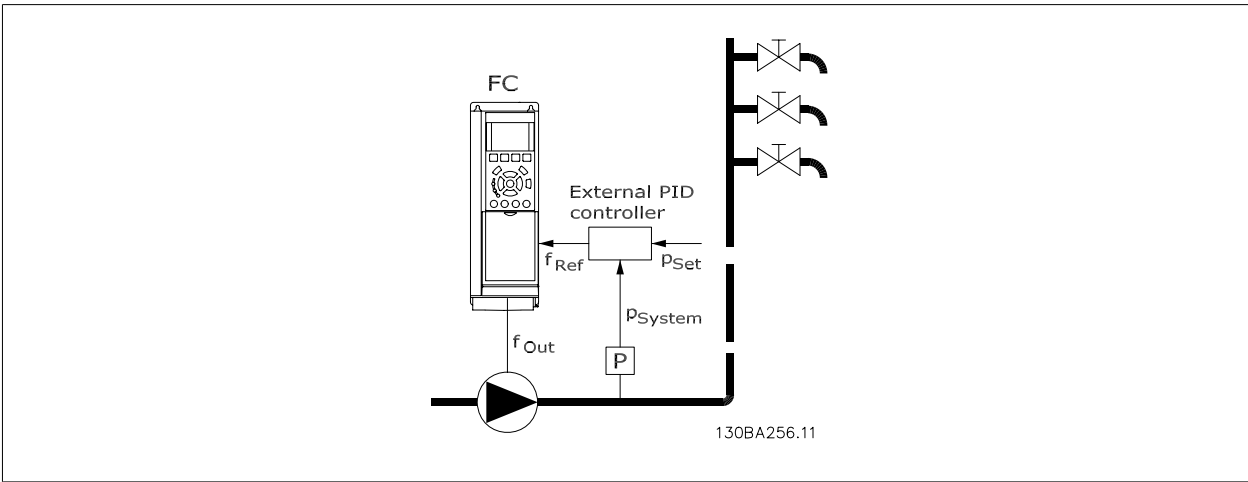

2) In systems where the pressure or temperature is controlled by an external PI controller, the wake up conditions can not be based on feedback from the pressure/temperature transducer as the setpoint is not known. In the example with a boost system, desired pressure Pset is not known. par. 1-00 Configuration Mode must be set for Open Loop.

Example: Boost system.

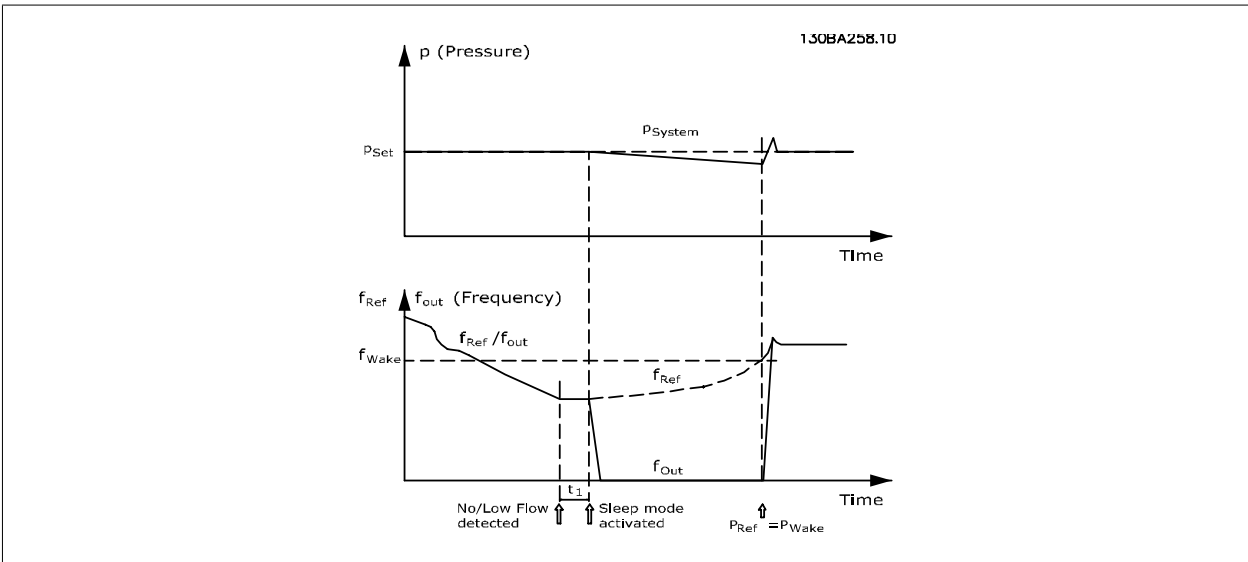

When low power or low speed is detected the motor is stopped, but the reference signal (f_{ref}) from the external controller is still monitored and because of the low pressure created, the controller will increase the reference signal to gain pressure. When the reference signal has reached a set value f_{wake} the motor restarts.

The speed is set manually by an external reference signal (Remote Reference). The settings (par. 22-3*) for tuning of the No Flow function must be set to default.

Configuration possibilities, overview:

	Internal PI Controller (par. 1-00 Configuration Mode: Closed loop)		External PI Controller or manual control (par. 1-00 Configuration Mode: Open loop)	
	Sleep mode	Wake up	Sleep mode	Wake up
No Flow detection (pumps only)	Yes		Yes (except manual setting of speed)	
Low speed detection	Yes		Yes	
External signal	Yes		Yes	
Pressure/Temperature (transmitter connected)		Yes		No
Output frequency		No		Yes

 **NB!**
 Sleep Mode will not be active when Local Reference is active (set speed manually by means of arrow buttons on the Local Control Panel). See par. 3-13 *Reference Site*.
 Does not work in Hand-mode. Auto set-up in open loop must be carried out before setting input/output in closed loop.

22-40 Minimum Run Time

Range:	Function:
10 s* [0 - 600 s]	Set the desired minimum running time for the motor after a start command (digital input or Bus) before entering Sleep Mode.

22-41 Minimum Sleep Time

Range:	Function:
10 s* [0 - 600 s]	Set the desired Minimum Time for staying in Sleep Mode. This will override any wake up conditions.

22-42 Wake-up Speed [RPM]

Range:	Function:
0 RPM* [par. 4-11 - par. 4-13 RPM]	To be used if par. 0-02 <i>Motor Speed Unit</i> has been set for RPM (parameter not visible if Hz selected). Only to be used if par. 1-00 <i>Configuration Mode</i> is set for Open Loop and speed reference is applied by an external controller. Set the reference speed at which the Sleep Mode should be cancelled.

22-43 Wake-up Speed [Hz]

Range:	Function:
0 Hz* [par. 4-12 - par. 4-14 Hz]	To be used if par. 0-02 <i>Motor Speed Unit</i> , has been set for Hz (parameter not visible if RPM selected). Only to be used if par. 1-00 <i>Configuration Mode</i> , is set for Open Loop and speed reference is applied by an external controller controlling the pressure. Set the reference speed at which the Sleep Mode should be cancelled.

22-44 Wake-up Ref./FB Difference

Range:	Function:
10 %* [0 - 100 %]	Only to be used if par. 1-00 <i>Configuration Mode</i> is set for Closed Loop and the integrated PI controller is used for controlling the pressure. Set the pressure drop allowed in percentage of set point for the pressure (Pset) before cancelling the Sleep Mode.

 **NB!**
 If used in application where the integrated PI controller is set for inverse control (e.g. cooling tower applications) in par. 20-71 *PID Performance*, the value set in par. 22-44 *Wake-up Ref./FB Difference* will automatically be added.

22-45 Setpoint Boost

Range:	Function:
0 %* [-100 - 100 %]	Only to be used if par. 1-00 <i>Configuration Mode</i> , is set for Closed Loop and the integrated PI controller is used. In systems with e.g. constant pressure control, it is advantageous to increase the system pressure before the motor is stopped. This will extend the time in which the motor is stopped and help to avoid frequent start/stop. Set the desired over pressure/temperature in percentage of set point for the pressure (Pset)/temperature before entering the Sleep Mode. If setting for 5%, the boost pressure will be Pset*1.05. The negative values can be used for e.g. cooling tower control where a negative change is needed.

22-46 Maximum Boost Time

Range:

60 s* [0 - 600 s]

Function:

Only to be used if par. 1-00 *Configuration Mode* is set for Closed Loop and the integrated PI controller is used for controlling the pressure.

Set the maximum time for which boost mode will be allowed. If the set time is exceeded, Sleep Mode will be entered, not waiting for the set boost pressure to be reached.

3

3.20.4 End of Curve, 22-5*

The End of Curve conditions occur when a pump is yielding a too large volume to ensure the set pressure. This can occur if there is a leakage in the distribution pipe system after the pump causing the pump to operate at the end of the pump characteristic, valid for the max. speed set in par. 4-13 *Motor Speed High Limit [RPM]* or par. 4-14 *Motor Speed High Limit [Hz]*.

In case the feed back is 2.5% of the programmed value in par. 20-14, Maximum Reference (or numerical value of par. 20-13 Minimum Reference whichever is highest) below the set point for the desired pressure for a set time (par. 22-51 *End of Curve Delay*), and the pump is running with max. speed set in par. 4-13 *Motor Speed High Limit [RPM]* or par. 4-14 *Motor Speed High Limit [Hz]*, - the function selected in par. 22-50 *End of Curve Function* will take place.

It is possible to get a signal on one of the digital outputs by selecting End of Curve [192] in par. 5-3* *Digital Outputs* and/or par. 5-4* *Relays*. The signal will be present, when an End of Curve condition occurs and the selection in par. 22-50 *End of Curve Function*, is different from Off. The end of curve function can only be used when operating with the built-in PID controller (Closed loop in par. 1-00 *Configuration Mode*).

22-50 End of Curve Function

Option:

[0] * Off

Function:

End of Curve monitoring not active.

[1] Warning

A warning is issued in the display [W94].

[2] Alarm

An alarm is issued and the frequency converter trips. A message [A94] appears in the display.

NB!

Automatic restart will reset the alarm and start the system again.

22-51 End of Curve Delay

Range:

10 s* [0 - 600 s]

Function:

When an End of Curve condition is detected, a timer is activated. When the time set in this parameter expires, and the End of Curve condition has been steady in the entire period, the function set in par. 22-50 *End of Curve Function* will be activated. If the condition disappears before the timer expires, the timer will be reset.

3.20.5 22-6* Broken Belt Detection

The Broken Belt Detection can be used in both closed and open loop systems for pumps, fans and compressors. If the estimated motor torque is below the broken belt torque value (par. 22-61 *Broken Belt Torque*) and the frequency converter output frequency is above or equal to 15 Hz, the broken belt function (par. 22-60 *Broken Belt Function*) is performed

22-60 Broken Belt Function

Option:

[0] * Off

Function:

Selects the action to be performed if the Broken Belt condition is detected

[1] Warning

[2] Trip

22-61 Broken Belt Torque

Range:	Function:
10 %* [0 - 100 %]	Sets the broken belt torque as a percentage of the rated motor torque.

22-62 Broken Belt Delay

Range:	Function:
10 s* [0 - 600 s]	Sets the time for which the Broken Belt conditions must be active before carrying out the action selected in par. 22-60 <i>Broken Belt Function</i> .

22-62 Broken Belt Delay

Range:	Function:
10 s* [0 - 600 s]	Sets the time for which the Broken Belt conditions must be active before carrying out the action selected in par. 22-60 <i>Broken Belt Function</i> .

3.20.6 22-7* Short Cycle Protection

When controlling refrigeration compressors, often there will be a need for limiting the numbers of starts. One way to do this is to ensure a minimum run time (time between a start and a stop) and a minimum interval between starts.

This means that any normal stop command can be overridden by the *Minimum Run Time* function (par. 22-77 *Minimum Run Time*) and any normal start command (Start/Jog/Freeze) can be overridden by the *Interval Between Starts* function (par. 22-76 *Interval between Starts*).

None of the two functions are active if *Hand On* or *Off* modes have been activated via the LCP. If selecting *Hand On* or *Off*, the two timers will be reset to 0, and not start counting until *Auto* is pressed and an active start command applied.

NB!
A Coast command or missing Run Permissive signal will override both Minimum Run Time and Interval Between Starts functions.

22-75 Short Cycle Protection

Option:	Function:
[0] * Disabled	Timer set in par. 22-76 <i>Interval between Starts</i> is disabled.
[1] Enabled	Timer set in par. 22-76 <i>Interval between Starts</i> is enabled.

22-76 Interval between Starts

Range:	Function:
par. 22-77 [par. 22-77 - 3600 s] s*	Sets the time desired as minimum time between two starts. Any normal start command (Start/Jog/Freeze) will be disregarded until the timer has expired.

22-77 Minimum Run Time

Range:	Function:
0 s* [0 - par. 22-76 s]	Sets the time desired as minimum run time after a normal start command (Start/Jog/Freeze). Any normal stop command will be disregarded until the set time has expired. The timer will start counting following a normal start command (Start/Jog/Freeze). The timer will be overridden by a Coast (Inverse) or an External Interlock command.

NB!
Does not work in cascade mode.

3.20.7 22-8* Flow Compensation

It is sometimes the case that it is not possible for a pressure transducer to be placed at a remote point in the system and it can only be located close to the fan/pump outlet. Flow compensation operates by adjusting the set-point according to the output frequency, which is almost proportional to flow, thus compensating for higher losses at higher flow rates.

H_{DESIGN} (Required pressure) is the setpoint for closed loop (PI) operation of the frequency converter and is set as for closed loop operation without flow compensation.

It is recommended to use slip compensation and RPM as unit.

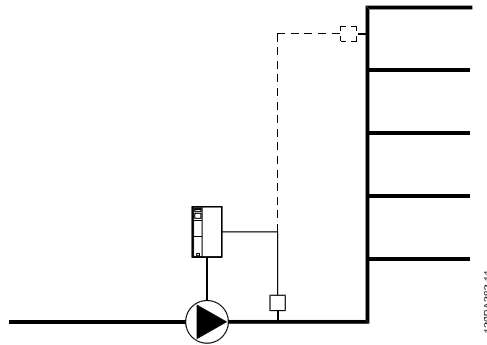

NB!

When flow compensation is used with the Cascade Controller (parameter group 25), the actual set-point will not depend on speed (flow) but on the number of pumps cut in. See below:

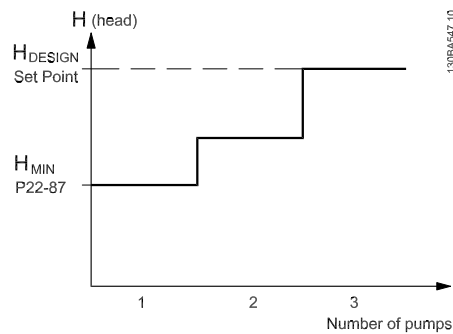

There are two methods which can be employed, depending upon whether or not the Speed at System design Working Point is known.

Parameter used	Speed at Design Point KNOWN	Speed at Design Point UNKNOWN	Cascade Controller
Flow Compensation, 22-80	+	+	+
Square-Linear Curve Approximation, 22-81	+	+	-
Work Point Calculation, 22-82	+	+	-
Speed at No Flow, 22-83/84	+	+	-
Speed at Design Point, 22-85/86	+	-	-
Pressure at No Flow, 22-87	+	+	+
Pressure at Rated Speed, 22-88	-	+	-
Flow at Design Point, 22-89	-	+	-
Flow at Rated Speed, 22-90	-	+	-

22-80 Flow Compensation

Option:	Function:
[0] * Disabled	[0] <i>Disabled</i> : Set-Point compensation not active.
[1] Enabled	[1] <i>Enabled</i> : Set-Point compensation is active. Enabling this parameter allows the Flow Compensated Setpoint operation.

22-81 Square-linear Curve Approximation

Range:	Function:
100 %* [0 - 100 %]	<p>Example 1: Adjustment of this parameter allows the shape of the control curve to be adjusted. 0 = Linear 100% = Ideal shape (theoretical).</p>

 **NB!**
Please note: Not visible when running in cascade.

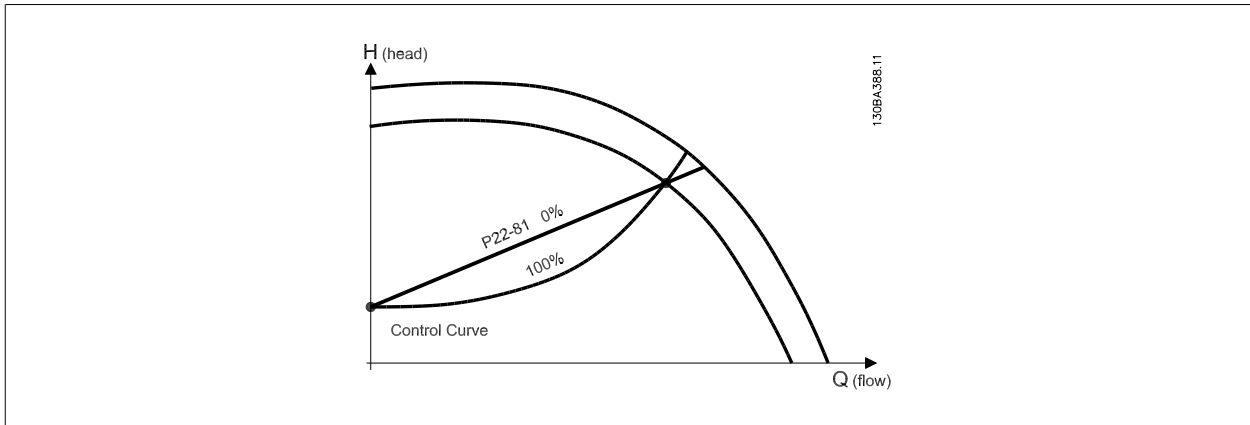

22-82 Work Point Calculation

Option:

Function:

Example 1: Speed at System Design Working Point is known:

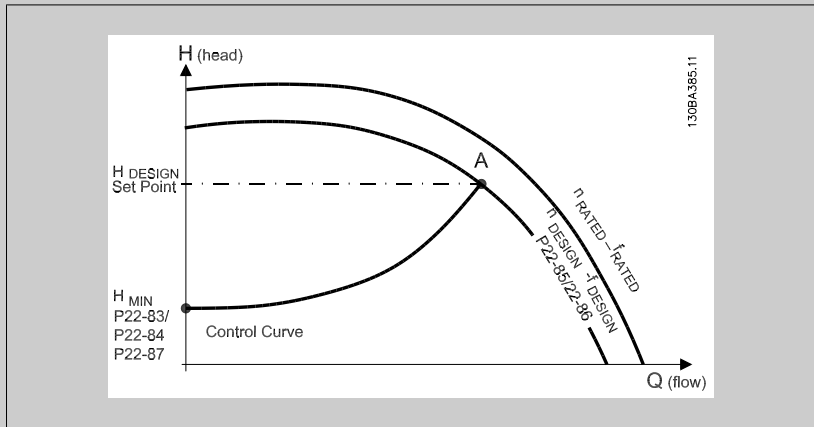

From the data sheet showing characteristics for the specific equipment at different speeds, simply reading across from the H_{DESIGN} point and the Q_{DESIGN} point allows us to find point A, which is the System Design Working Point. The pump characteristics at this point should be identified and the associated speed programmed. Closing the valves and adjusting the speed until H_{MIN} has been achieved allows the speed at the no flow point to be identified.

Adjustment of par. 22-81 *Square-linear Curve Approximation* then allows the shape of the control curve to be adjusted infinitely.

Example 2:

Speed at System Design Working Point is not known: Where the Speed at System Design Working Point is unknown, another reference point on the control curve needs to be determined by means of the data sheet. By looking at the curve for the rated speed and plotting the design pressure (H_{DESIGN} , Point C) the flow at that pressure Q_{RATED} can be determined. Similarly, by plotting the design flow (Q_{DESIGN} , Point D), the pressure H_D at that flow can be determined. Knowing these two points on the pump curve, along with H_{MIN} as described above, allows the frequency converter to calculate the reference point B and thus to plot the control curve which will also include the System design Working Point A.

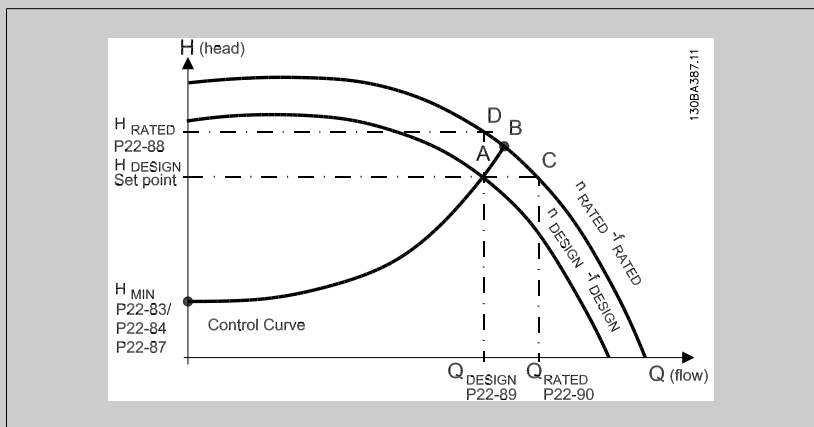

[0] * Disabled

Disabled [0]: Work Point Calculation not active. To be used if speed at design point is known (see table above).

[1] Enabled

Enabled [1]: Work Point Calculation is active. Enabling this parameter allows the calculation of the unknown System Design Working Point at 50/60 Hz speed, from the input data set in par. 22-83 *Speed at No-Flow [RPM]*, par. 22-84 *Speed at No-Flow [Hz]*, par. 22-87 *Pressure at No-Flow Speed*, par. 22-88 *Pressure at Rated Speed*, par. 22-89 *Flow at Design Point* and par. 22-90 *Flow at Rated Speed*.

22-83 Speed at No-Flow [RPM]**Range:**

300. RPM* [0 - par. 22-85 RPM]

Function:

Resolution 1 RPM.

The speed of the motor at which flow is zero and minimum pressure H_{MIN} is achieved should be entered here in RPM. Alternatively, the speed in Hz can be entered in par. 22-84 *Speed at No-Flow [Hz]*. If it has been decided to use RPM in par. 0-02 *Motor Speed Unit* then par. 22-85 *Speed at Design Point [RPM]* should also be used. Closing the valves and reducing the speed until minimum pressure H_{MIN} is achieved will determine this value.

22-84 Speed at No-Flow [Hz]**Range:**

50.0 Hz* [0.0 - par. 22-86 Hz]

Function:

Resolution 0.033 Hz.

The speed of the motor at which flow has effectively stopped and minimum pressure H_{MIN} is achieved should be entered here in Hz. Alternatively, the speed in RPM can be entered in par. 22-83 *Speed at No-Flow [RPM]*. If it has been decided to use Hz in par. 0-02 *Motor Speed Unit* then par. 22-86 *Speed at Design Point [Hz]* should also be used. Closing the valves and reducing the speed until minimum pressure H_{MIN} is achieved will determine this value.

22-85 Speed at Design Point [RPM]**Range:**

1500. RPM* [par. 22-83 - 60000. RPM]

Function:

Resolution 1 RPM.

Only visible when par. 22-82 *Work Point Calculation* is set to *Disable*. The speed of the motor at which the System Design Working Point is achieved should be entered here in RPM. Alternatively, the speed in Hz can be entered in par. 22-86 *Speed at Design Point [Hz]*. If it has been decided to use RPM in par. 0-02 *Motor Speed Unit* then par. 22-83 *Speed at No-Flow [RPM]* should also be used.

22-86 Speed at Design Point [Hz]**Range:**

50/60.0 Hz* [par. 22-84 - par. 4-19 Hz]

Function:

Resolution 0.033 Hz.

Only visible when par. 22-82 *Work Point Calculation* is set to *Disable*. The speed of the motor at which the System Design Working Point is achieved should be entered here in Hz. Alternatively, the speed in RPM can be entered in par. 22-85 *Speed at Design Point [RPM]*. If it has been decided to use Hz in par. 0-02 *Motor Speed Unit*, then par. 22-83 *Speed at No-Flow [RPM]* should also be used.

22-87 Pressure at No-Flow Speed**Range:**

0.000 N/A* [0.000 - par. 22-88 N/A]

Function:Enter the pressure H_{MIN} corresponding to Speed at No Flow in Reference/Feedback Units.**22-88 Pressure at Rated Speed****Range:**

999999.999 N/A* [par. 22-87 - 999999.999 N/A]

Function:

Enter the value corresponding to the Pressure at Rated Speed, in Reference/Feedback Units. This value can be defined using the pump datasheet.

22-89 Flow at Design Point**Range:**

0.000 N/A* [0.000 - 999999.999 N/A]

Function:

Enter the value corresponding to the Flow at Design Point. No units necessary.

22-90 Flow at Rated Speed**Range:**

0.000 N/A* [0.000 - 999999.999 N/A]

Function:

Enter the value corresponding to Flow at Rated Speed. This value can be defined using the pump datasheet.

3.21 Main Menu - Time-based Functions - FC 100 - Group 23

3.21.1 Timed Actions, 23-0*

Use *Timed Actions* for actions needing to be performed on a daily or weekly basis, e.g. different references for working hours / non-working hours. Up to 10 Timed Actions can be programmed in the frequency converter. The Timed Action number is selected from the list when entering parameter group 23-0* from the Local Control Panel. par. 23-00 *ON Time* – par. 23-04 *Occurrence* then refer to the selected Timed Action number. Each Timed Action is divided into an ON time and an OFF time, in which two different actions may be performed.

The actions programmed in Timed Actions are merged with corresponding actions from digital inputs, control work via bus and Smart Logic Controller, according to merge rules set up in 8-5*, Digital/Bus.

**NB!**

The clock (parameter group 0-7*) must be correctly programmed for Timed Actions to function correctly.

**NB!**

When mounting an Analog I/O MCB109 option card, a battery back up of the date and time is included.

NB!

The PC-based Configuration Tool MCT 10 comprise a special guide for easy programming of Timed Actions.

23-00 ON Time

Array [10]

Range:

0 N/A* [0 - 0 N/A]

Function:

Sets the ON time for the Timed Action.

**NB!**

The frequency converter has no back up of the clock function and the set date/time will reset to default (2000-01-01 00:00) after a power down unless a Real Time Clock module with back up is installed. In par. 0-79 *Clock Fault* it is possible to program for a Warning in case clock has not been set properly, e.g. after a power down.

23-01 ON Action

Arra [10]

Option:**Function:**

Select the action during ON Time. See par. 13-52 *SL Controller Action* for descriptions of the options.

[0] * Disabled

[1] No action

[2] Select set-up 1

[3] Select set-up 2

[4] Select set-up 3

[5] Select set-up 4

[10] Select preset ref 0

[11] Select preset ref 1

[12] Select preset ref 2

[13]	Select preset ref 3
[14]	Select preset ref 4
[15]	Select preset ref 5
[16]	Select preset ref 6
[17]	Select preset ref 7
[18]	Select ramp 1
[19]	Select ramp 2
[22]	Run
[23]	Run reverse
[24]	Stop
[26]	DC Brake
[27]	Coast
[28]	Freeze output
[29]	Start timer 0
[30]	Start timer 1
[31]	Start timer 2
[32]	Set digital out A low
[33]	Set digital out B low
[34]	Set digital out C low
[35]	Set digital out D low
[36]	Set digital out E low
[37]	Set digital out F low
[38]	Set digital out A high
[39]	Set digital out B high
[40]	Set digital out C high
[41]	Set digital out D high
[42]	Set digital out E high
[43]	Set digital out F high
[60]	Reset Counter A
[61]	Reset Counter B
[70]	Start Timer 3
[71]	Start Timer 4
[72]	Start Timer 5
[73]	Start Timer 6
[74]	Start Timer 7

NB!
 For choices [32] - [43], see also par. group 5-3*, *Digital Outputs* and 5-4*, *Relays*.

23-02 OFF Time

Array [10]

Range:

0 N/A* [0 - 0 N/A]

Function:

Sets the OFF time for the Timed Action.

NB!

The frequency converter has no back up of the clock function and the set date/time will reset to default (2000-01-01 00:00) after a power down unless a Real Time Clock module with back up is installed. In par. 0-79 *Clock Fault* it is possible to program for a Warning in case clock has not been set properly, e.g. after a power down.

23-03 OFF Action

Array [10]

Option:
Function:

Select the action during OFF Time. See par. 13-52 *SL Controller Action* for descriptions of the options.

[0] * Disabled

[1] No action

[2] Select set-up 1

[3] Select set-up 2

[4] Select set-up 3

[5] Select set-up 4

[10] Select preset ref 0

[11] Select preset ref 1

[12] Select preset ref 2

[13] Select preset ref 3

[14] Select preset ref 4

[15] Select preset ref 5

[16] Select preset ref 6

[17] Select preset ref 7

[18] Select ramp 1

[19] Select ramp 2

[22] Run

[23] Run reverse

[24] Stop

[26] DC Brake

[27] Coast

[28] Freeze output

[29] Start timer 0

[30] Start timer 1

[31] Start timer 2

[32] Set digital out A low

[33] Set digital out B low

[34] Set digital out C low

[35] Set digital out D low

[36] Set digital out E low

[37] Set digital out F low

[38]	Set digital out A high
[39]	Set digital out B high
[40]	Set digital out C high
[41]	Set digital out D high
[42]	Set digital out E high
[43]	Set digital out F high
[60]	Reset Counter A
[61]	Reset Counter B
[70]	Start Timer 3
[71]	Start Timer 4
[72]	Start Timer 5
[73]	Start Timer 6
[74]	Start Timer 7

23-04 Occurrence

Array [10]

Option:

Function:

Select which day(s) the Timed Action applies to. Specify working/non-working days in par. 0-81 *Working Days*, par. 0-82 *Additional Working Days* and par. 0-83 *Additional Non-Working Days*.

[0] *	All days
[1]	Working days
[2]	Non-working days
[3]	Monday
[4]	Tuesday
[5]	Wednesday
[6]	Thursday
[7]	Friday
[8]	Saturday
[9]	Sunday

3.21.2 23-1 * Maintenance

Wear and tear calls for periodic inspection and service of elements in the application, e.g. motor bearings, feedback sensors and seals or filters. With Preventive Maintenance the service intervals may be programmed into the frequency converter. The frequency converter will give a message when maintenance is required. 20 Preventive Maintenance Events can be programmed into the frequency converter. For each Event the following must be specified:

- Maintenance item (e.g. "Motor Bearings")
- Maintenance action (e.g. "Replace")
- Maintenance Time Base (e.g. "Running Hours" or a specific date and time)
- Maintenance Time Interval or the date and time of next maintenance



NB!

To disable a Preventive Maintenance Event the associated par. 23-12 *Maintenance Time Base* must be set to *Disabled* [0].

Preventive Maintenance can be programmed from the LCP, but use of the PC-based VLT Motion Control Tool MCT10 is recommended.

3

ID	Name	Setup 1	Setup 2	Setup 3	Setup 4
2310.0	Maintenance Item	Motor bearings	Motor bearings	Motor bearings	Motor bearings
2310.1	Maintenance Item	Motor bearings	Motor bearings	Motor bearings	Motor bearings
2310.2	Maintenance Item	Motor bearings	Motor bearings	Motor bearings	Motor bearings
2310.3	Maintenance Item	Motor bearings	Motor bearings	Motor bearings	Motor bearings
2310.4	Maintenance Item	Motor bearings	Motor bearings	Motor bearings	Motor bearings
2310.5	Maintenance Item	Motor bearings	Motor bearings	Motor bearings	Motor bearings
2310.6	Maintenance Item	Motor bearings	Motor bearings	Motor bearings	Motor bearings
2310.7	Maintenance Item	Motor bearings	Motor bearings	Motor bearings	Motor bearings
2310.8	Maintenance Item	Motor bearings	Motor bearings	Motor bearings	Motor bearings
2310.9	Maintenance Item	Motor bearings	Motor bearings	Motor bearings	Motor bearings
2310.10	Maintenance Item	Motor bearings	Motor bearings	Motor bearings	Motor bearings
2310.11	Maintenance Item	Motor bearings	Motor bearings	Motor bearings	Motor bearings
2310.12	Maintenance Item	Motor bearings	Motor bearings	Motor bearings	Motor bearings
2310.13	Maintenance Item	Motor bearings	Motor bearings	Motor bearings	Motor bearings
2310.14	Maintenance Item	Motor bearings	Motor bearings	Motor bearings	Motor bearings
2310.15	Maintenance Item	Motor bearings	Motor bearings	Motor bearings	Motor bearings
2310.16	Maintenance Item	Motor bearings	Motor bearings	Motor bearings	Motor bearings
2310.17	Maintenance Item	Motor bearings	Motor bearings	Motor bearings	Motor bearings
2310.18	Maintenance Item	Motor bearings	Motor bearings	Motor bearings	Motor bearings
2310.19	Maintenance Item	Motor bearings	Motor bearings	Motor bearings	Motor bearings
2311.0	Maintenance Action	Lubricate	Lubricate	Lubricate	Lubricate
2311.1	Maintenance Action	Lubricate	Lubricate	Lubricate	Lubricate
2311.2	Maintenance Action	Lubricate	Lubricate	Lubricate	Lubricate
2311.3	Maintenance Action	Lubricate	Lubricate	Lubricate	Lubricate
2311.4	Maintenance Action	Lubricate	Lubricate	Lubricate	Lubricate
2311.5	Maintenance Action	Lubricate	Lubricate	Lubricate	Lubricate
2311.6	Maintenance Action	Lubricate	Lubricate	Lubricate	Lubricate

130BA492.10

The LCP indicates (with a wrench-icon and an "M") when it is time for a Preventive Maintenance Action, and can be programmed to be indicated on a digital output in parameter group 5-3*. The Preventive Maintenance Status may be read in par. 16-96 *Maintenance Word*. A Preventive Maintenance indication can be reset from a digital input, the FC bus or manually from the Local Control Panel through par. 23-15 *Reset Maintenance Word*.

A Maintenance Log with the latest 10 loggings can be read from parameter group 18-0* and via the Alarm log button on the LCP after selecting Maintenance Log.

23-10 Maintenance Item

Option:

Function:

Select the item to be associated with the Preventive Maintenance Event.

- [1] * Motor bearings
- [2] Fan bearings
- [3] Pump bearings
- [4] Valve
- [5] Pressure transmitter
- [6] Flow transmitter
- [7] Temperature transm.
- [8] Pump seals
- [9] Fan belt
- [10] Filter
- [11] Drive cooling fan
- [12] System health check
- [13] Warranty
- [20] Maintenance Text 0
- [21] Maintenance Text 1
- [22] Maintenance Text 2

- [23] Maintenance Text 3
- [24] Maintenance Text 4
- [25] Maintenance Text 5



NB!

The Preventive Maintenance Events are defined in a 20 element array. Hence each Preventive Maintenance Event must use the same array element index in par. 23-10 *Maintenance Item* to par. 23-14 *Maintenance Date and Time*.

23-11 Maintenance Action

Option:

Function:

Select the action to be associated with the Preventive Maintenance Event.

- [1] * Lubricate
- [2] Clean
- [3] Replace
- [4] Inspect/Check
- [5] Overhaul
- [6] Renew
- [7] Check
- [20] Maintenance Text 0
- [21] Maintenance Text 1
- [22] Maintenance Text 2
- [23] Maintenance Text 3
- [24] Maintenance Text 4
- [25] Maintenance Text 5

23-12 Maintenance Time Base

Option:

Function:

Select the time base to be associated with the Preventive Maintenance Event.

- [0] * Disabled *Disabled* [0] must be used when disabling the Preventive Maintenance Event.
- [1] Running Hours *Running Hours* [1] is the number of hours the motor has been running. Running hours are not reset at power-on. The *Maintenance Time Interval* must be specified in par. 23-13 *Maintenance Time Interval*.
- [2] Operating Hours *Operating Hours* [2] is the number of hours the frequency converter has been running. Operating hours are not reset at power-on. The *Maintenance Time Interval* must be specified in par. 23-13 *Maintenance Time Interval*.
- [3] Date & Time *Date & Time* [3] uses the internal clock. The date and time of the next maintenance occurrence must be specified in par. 23-14 *Maintenance Date and Time*.

23-13 Maintenance Time Interval

Range:

Function:

1 h* [1 - 2147483647 h] Set the interval associated with the current Preventive Maintenance Event. This parameter is only used if *Running Hours* [1] or *Operating Hours* [2] is selected in par. 23-12 *Maintenance Time Base*. The timer is reset from par. 23-15 *Reset Maintenance Word*.

Example:

A Preventive Maintenance Event is set up Monday at 8:00. par. 23-12 *Maintenance Time Base* is *Operating hours* [2] and par. 23-13 *Maintenance Time Interval* is 7 x 24 hours=168 hours. Next Maintenance Event will be indicated the following Monday at 8:00. If this Maintenance Event is not reset until Tuesday at 9:00, the next occurrence will be the following Tuesday at 9:00.

23-14 Maintenance Date and Time

Range:

0 N/A* [0 - 0 N/A]

Function:

Set the date and time for next maintenance occurrence if the Preventive Maintenance Event is based on date/time. Date format depends on the setting in par. 0-71 *Date Format* while the time format depends on the setting in par. 0-72 *Time Format*.

NB!

The frequency converter has no back up of the clock function and the set date/time will reset to default (2000-01-01 00:00) after a power down. In par. 0-79 *Clock Fault* it is possible to program for a Warning in case the clock has not been set properly, e.g. after a power down.

The time set must be at least one hour from the actual time!

NB!

When mounting an Analog I/O MCB109 option card, a battery back up of the date and time is included.

23-15 Reset Maintenance Word

Option:

[0] * Do not reset

[1] Do reset

Function:

Set this parameter to *Do reset* [1] to reset the Maintenance Word in par. 16-96 *Maintenance Word* and reset the message displayed in the LCP. This parameter will change back to *Do not reset* [0] when pressing OK.

NB!

When messages are reset - Maintenance Item, Action and Maintenance Date/Time are not cancelled. par. 23-12 *Maintenance Time Base* is set to Disabled [0].

23-16 Maintenance Text

Range:

[Array with 6 elements [0-5]]

Function:

6 individual texts (Maintenance Text 0...Maintenance Text 5) can be written for use in either par. 23-10, *Maintenance Item* or par. 23-11, *Maintenance Action*.

The text is written according to the guidelines in par. 0-37, *Display Text*.

3.21.3 Energy Log, 23-5*

The frequency converter is continuously accumulating the consumption of the motor controlled, based on the actual power yielded by the frequency converter.

These data can be used for an Energy Log function allowing the user to compare and structure the information about the energy consumption related to time.

There are basically two functions:

- Data related to a pre-programmed period, defined by a set date and time for start
- Data related to a predefined period back in time e.g. last seven days within the pre-programmed period

For each of the above two functions, the data are stored in a number of counters allowing for selecting time frame and a split on hours, days or weeks. The period/split (resolution) can be set in par. 23-50 *Energy Log Resolution*.

The data are based on the value registered by the kWh counter in the frequency converter. This counter value can be read in par. 15-02 *kWh Counter* containing the accumulated value since the first power up or latest reset of the counter (par. 15-06 *Reset kWh Counter*).

All data for the Energy Log are stored in counters which can be read from par. 23-53 *Energy Log*.

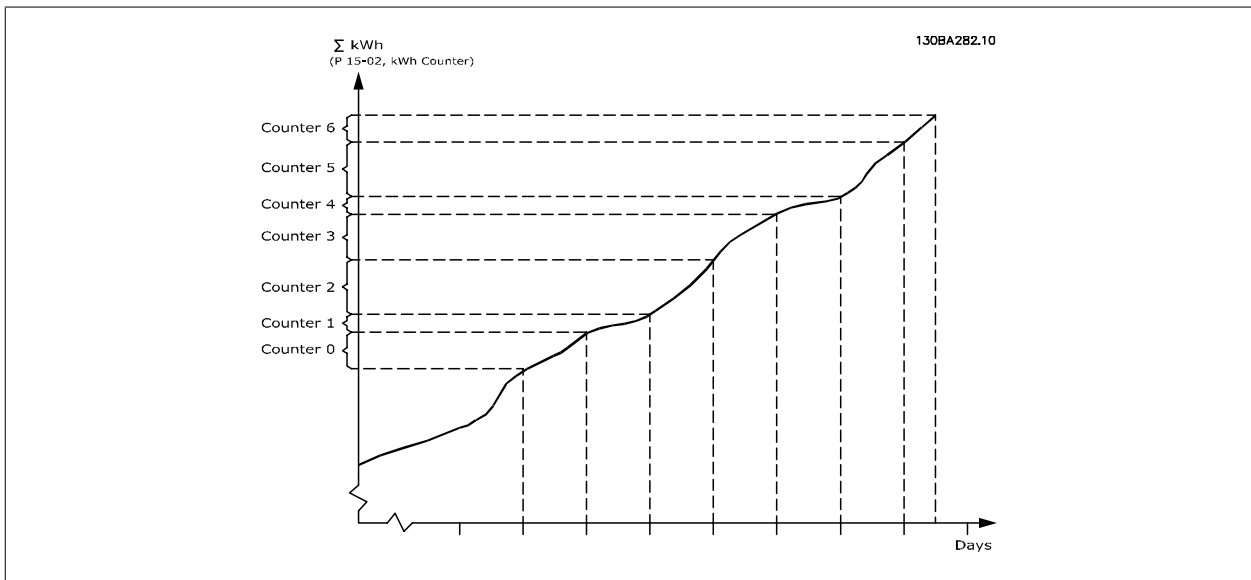

Counter 00 will always contain the oldest data. A counter will cover a period from XX:00 to XX:59 if hours or 00:00 to 23:59 if days.

If logging either the last hours or last days, the counters will shift contents at XX:00 every hour or at 00:00 every day.

Counter with highest index will always be subject to update (containing data for the actual hour since XX:00 or the actual day since 00:00).

The contents of counters can be displayed as bars on LCP. Select *Quick Menu, Loggings, Energy Log: Trending Continued Bin / Trending Timed Bin / Trending Comparison*.

23-50 Energy Log Resolution

Option:
Function:

Select the desired type of period for logging of consumption. Hour of Day [0], Day of Week [1] or Day of Month [2]. The counters contain the logging data from the programmed date/time for start (par. 23-51 *Period Start*) and the numbers of hours/days as programmed for (par. 23-50 *Energy Log Resolution*).

The logging will start on the date programmed in par. 23-51 *Period Start*, and continue until one day/week/month has gone. Last 24 Hours [5], Last 7 Days [6] or Last 5 Weeks [7]. The counters contain data for one day, one week or five weeks back in time and up to the actual time.

The logging will start at the date programmed in par. 23-51 *Period Start*. In all cases the period split will refer to Operating Hours (time where frequency converter is powered up).

[0]	Hour of Day
[1]	Day of Week
[2]	Day of Month
[5] *	Last 24 Hours
[6]	Last 7 Days
[7]	Last 5 Weeks

NB!

The frequency converter has no back up of the clock function and the set date/time will reset to default (2000-01-01 00:00) after a power down unless a Real Time Clock module with back up is installed. Consequently the logging will be stopped until date/time is readjusted in par. 0-70 *Date and Time*. In par. 0-79 *Clock Fault* it is possible to program for a Warning in case clock not has been set properly, e.g. after a power down.

23-51 Period Start

Range:

0 N/A* [0 - 0 N/A]

Function:

Set the date and time at which the Energy Log starts update of the counters. First data will be stored in counter [00] and start at the time/date programmed in this parameter.

Date format will depend on setting in par. 0-71 *Date Format* and time format on setting in par. 0-72 *Time Format*.

NB!

When mounting an Analog I/O MCB109 option card, a battery back up of the date and time is included.

23-53 Energy Log

Range:

0 N/A* [0 - 4294967295 N/A]

Function:

Array with a number of elements equal to the number of counters ([00]-[xx] below parameter number in display). Press OK and Step between elements by means of ▲ and ▼ buttons on the Local Control Panel.

Array elements:

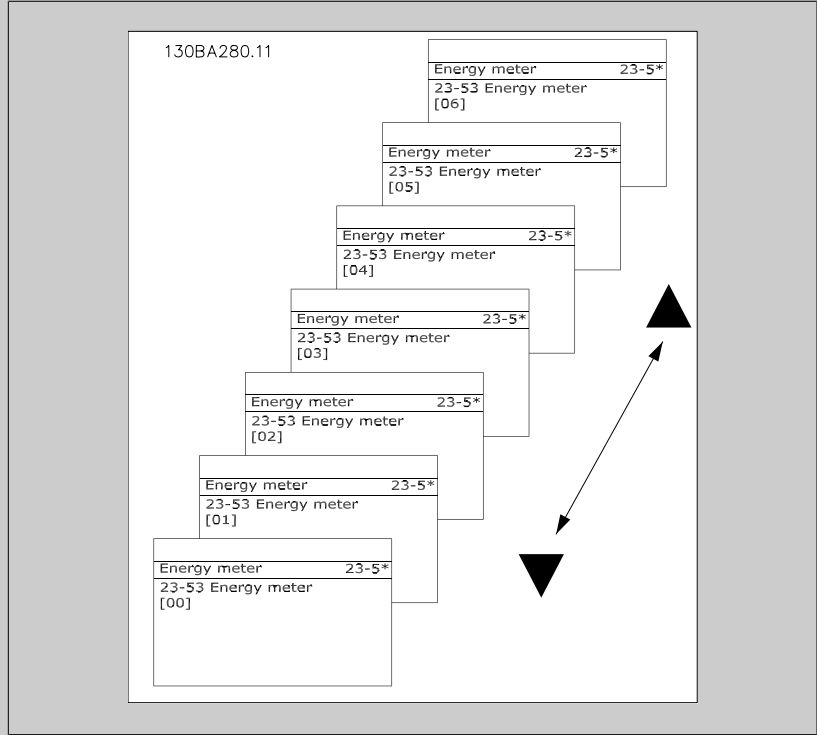

Data from latest period is stored in the counter with the highest index.
At power down all counter values are stored and resumed at next power up.



NB!

All counters are automatically reset when changing the setting in par. 23-50 *Energy Log Resolution*. At overflow the update of the counters will stop at maximum value.



NB!

When mounting an Analog I/O MCB109 option card, a battery back up of the date and time is included.

23-54 Reset Energy Log

Option:

Function:

Select *Do reset* [1] to reset all values in the Energy Log counters shown in par. 23-53 *Energy Log*. After pressing OK the setting of the parameter value will automatically change to *Do not reset* [0].

[0] * Do not reset

[1] Do reset

3.21.4 Trending, 23-6*

Trending is used to monitor a process variable over a period of time and record how often the data falls into each of ten user-defined data ranges. This is a convenient tool to get a quick overview indicating where to put focus for improvement of operation.

Two sets of data for Trending can be created in order to make it possible to compare current values for a selected operating variable with data for a certain reference period, for the same variable. This reference period can be pre-programmed (par. 23-63 *Timed Period Start* and par. 23-64 *Timed Period Stop*). The two sets of data can be read from par. 23-61 *Continuous Bin Data* (current) and par. 23-62 *Timed Bin Data* (reference).

3

It is possible to create Trending for following operation variables:

- Power
- Current
- Output frequency
- Motor Speed

The Trending function includes ten counters (forming a bin) for each set of data containing the numbers of registrations reflecting how often the operating variable is within each of ten pre-defined intervals. The sorting is based on a relative value of the variable.

The relative value for the operating variable is

Actual/Rated * 100%.

for Power and Current and

Actual/Max * 100%

for Output Frequency and Motor Speed.

The size of each interval can be adjusted individually, but will default be 10% for each. Power and Current can exceed rated value, but those registrations will be included in 90%-100% (MAX) counter.

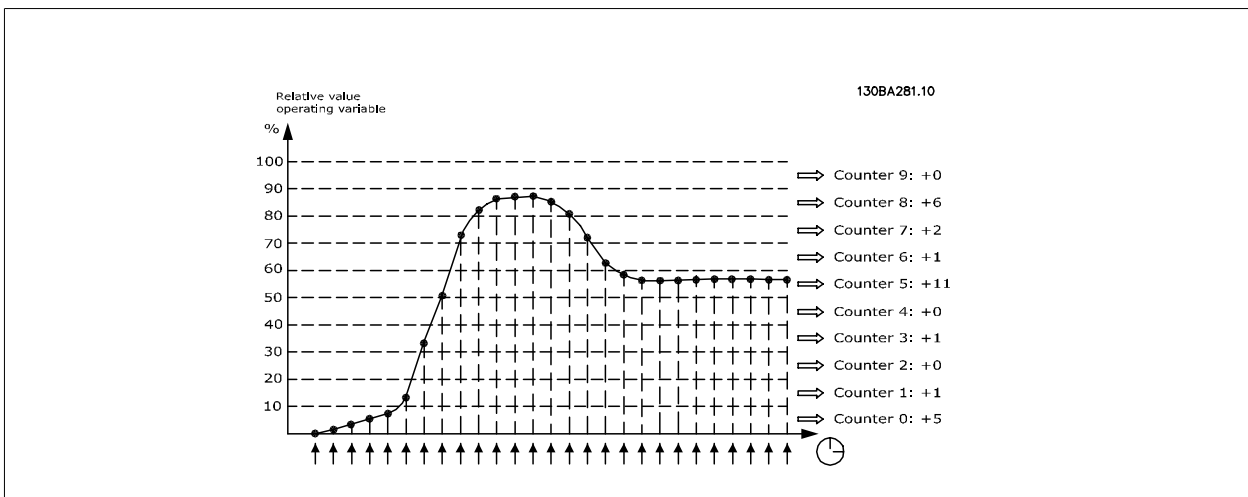

Once a second, the value of the operating variable selected is registered. If a value has been registered to equal 13%, the counter "10% - <20%" will be updated with the value "1". If the value stays at 13% for 10s, then "10" will be added to the counter value.

The contents of counters can be displayed as bars on LCP. Select *Quick Menu > Loggings: Trending Continued Bin / Trending Timed Bin / Trending Comparison*.

**NB!**

The counters starts counting whenever the frequency converter is powered-up. Power cycle shortly after a reset will zero the counters. EEPROM data are updated once per hour.

23-60 Trend Variable**Option:****Function:**

Select the desired operating variable to be monitored for Trending.

[0] *	Power [kW]	Power yielded to the motor. Reference for the relative value is the rated motor power programmed in par. 1-20 <i>Motor Power [kW]</i> or par. 1-21 <i>Motor Power [HP]</i> . Actual value can be read in par. 16-10 <i>Power [kW]</i> or par. 16-11 <i>Power [hp]</i> .
[1]	Current [A]	Output current to the motor. Reference for the relative value is the rated motor current programmed in par. 1-24 <i>Motor Current</i> . Actual value can be read in par. 16-14 <i>Motor Current</i> .
[2]	Frequency [Hz]	Output frequency to the motor. Reference for the relative value is the maximum output frequency programmed in par. 4-14 <i>Motor Speed High Limit [Hz]</i> . Actual value can be read in par. 16-13 <i>Frequency</i> .
[3]	Motor Speed [RPM]	Speed of the motor. Reference for relative value is the maximum motor speed programmed in par. 4-13 <i>Motor Speed High Limit [RPM]</i> .

23-61 Continuous Bin Data**Range:****Function:**

0 N/A* [0 - 4294967295 N/A]

Array with 10 elements ([0]-[9] below parameter number in display). Press OK and step between elements by means of ▲ and ▼ buttons on the LCP.

10 counters with the frequency of occurrence for the operating variable monitored, sorted according to the following intervals:

- Counter [0]: 0% - <10%
- Counter [1]: 10% - <20%
- Counter [2]: 20% - <30%
- Counter [3]: 30% - <40%
- Counter [4]: 40% - <50%
- Counter [5]: 50% - <60%
- Counter [6]: 60% - <70%
- Counter [7]: 70% - <80%
- Counter [8]: 80% - <90%
- Counter [9]: 90% - <100% or Max

The above minimum limits for the intervals are the default limits. These can be changed in par. 23-65 *Minimum Bin Value*.

Starts to count when the frequency converter is powered up for the first time. All counters can be reset to 0 in par. 23-66 *Reset Continuous Bin Data*.

23-62 Timed Bin Data**Range:****Function:**

0 N/A* [0 - 4294967295 N/A]

Array with 10 elements ([0]-[9] below parameter number in display). Press OK and step between elements by means of ▲ and ▼ buttons on the LCP.

10 counters with the frequency of occurrence for the operating data monitored sorted according to the intervals as for par. 23-61 *Continuous Bin Data*.

Starts to count at the date/time programmed in par. 23-63 *Timed Period Start*, and stops at the time/date programmed in par. 23-64 *Timed Period Stop*. All counters can be reset to 0 in par. 23-67 *Reset Timed Bin Data*.

23-63 Timed Period Start

Range:	Function:
0 N/A* [0 - 0 N/A]	Set the date and time at which the Trending starts the update of the Timed Bin counters. Date format will depend on setting in par. 0-71 <i>Date Format</i> , and time format on setting in par. 0-72 <i>Time Format</i> .

NB!
The frequency converter has no back up of the clock function and the set date/time will reset to default (2000-01-01 00:00) after a power down unless a Real Time Clock module with back up is installed. Consequently the logging will be stopped until date/time is readjusted in par. 0-70 *Date and Time*. In par. 0-79 *Clock Fault* it is possible to program for a Warning in case clock not has been set properly, e.g. after a power down.

NB!
When mounting an Analog I/O MCB109 option card, a battery back up of the date and time is included.

23-64 Timed Period Stop

Range:	Function:
0 N/A* [0 - 0 N/A]	Set the date and time at which the Trend Analyses must stop update of the Timed Bin counters. Date format will depend on setting in par. 0-71 <i>Date Format</i> , and time format on setting in par. 0-72 <i>Time Format</i> .

NB!
When mounting an Analog I/O MCB109 option card, a battery back up of the date and time is included.

23-65 Minimum Bin Value

Range:	Function:
0 %* [0 - 100. %]	Array with 10 elements ([0]-[9] below parameter number in display). Press OK and step between elements by means of ▲ and ▼ buttons on the LCP. Set the minimum limit for each interval in par. 23-61 <i>Continuous Bin Data</i> and par. 23-62 <i>Timed Bin Data</i> . Example: if selecting <i>counter</i> [1] and changing setting from 10% to 12%, <i>counter</i> [0] will be based on the interval 0 - <12% and <i>counter</i> [1] on interval 12% - <20%.

23-66 Reset Continuous Bin Data

Option:	Function:
	Select <i>Do reset</i> [1] to reset all values in par. 23-61 <i>Continuous Bin Data</i> . After pressing OK the setting of the parameter value will automatically change to <i>Do not reset</i> [0].
[0] * Do not reset	
[1] Do reset	

23-67 Reset Timed Bin Data

Option:	Function:
	Select <i>Do reset</i> [1] to reset all counters in par. 23-62 <i>Timed Bin Data</i> . After pressing OK the setting of the parameter value will automatically change to <i>Do not reset</i> [0].
[0] * Do not reset	
[1] Do reset	

3.21.5 23-8* Payback counter

The frequency converter includes a feature which can give a rough calculation on payback in cases where the frequency converter has been installed in an existing plant to ensure energy saving by changing from fixed to variable speed control. Reference for the savings is a set value to represent the average power yielded before the upgrade with variable speed control.

3

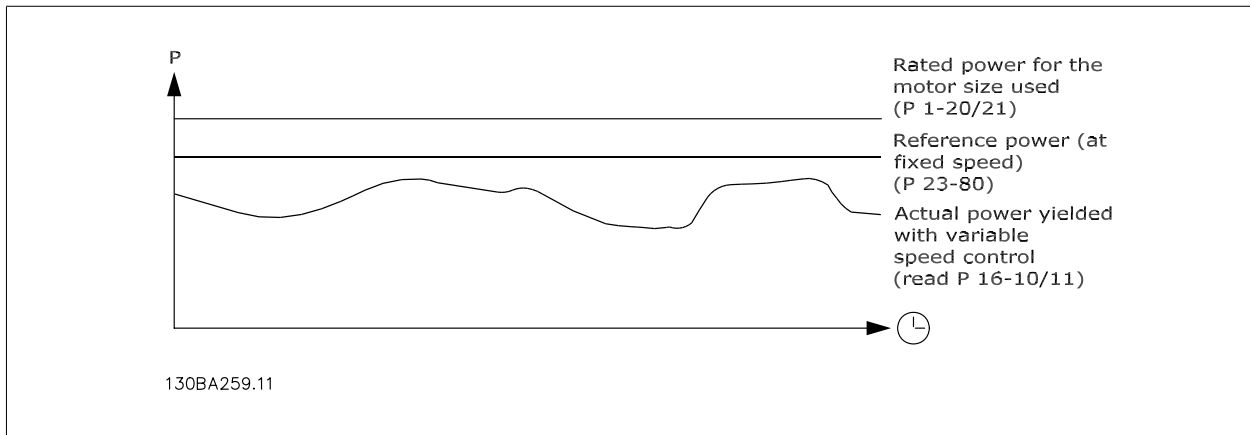

The difference between the Reference Power at fixed speed and the Actual Power yielded with speed control represent the actual saving.

As value for the fixed speed case, the rated motor size (kW) is multiplied with a factor (set in %) representing the power produced at fixed speed. The difference between this reference power and the actual power is accumulated and stored. The difference in energy can be read in par. 23-83 *Energy Savings*.

The accumulated value for the difference in power consumption is multiplied with the energy cost in local currency and the investment is subtracted. This calculation for Cost Savings can also be read in par. 23-84 *Cost Savings*.

$$Cost\ Savings = \left\{ \sum_{t=0}^t [(Rated\ Motor\ Power * Power\ Reference\ Factor) - Actual\ Power\ Consumption] \times Energy\ Cost \right\} - Investment\ Cost$$

Break even (payback) occurs when the value read in the parameter turns from negative to positive.

It is not possible to reset the Energy Savings counter, but the counter can be stopped any time by setting par. 28-80 to 0.

Parameter overview:

Parameter for settings		Parameters for readout	
Rated Motor Power	par. 1-20 <i>Motor Power [kW]</i>	Energy Savings	par. 23-83 <i>Energy Savings</i>
Power Reference Factor in %	par. 23-80 <i>Power Reference Factor</i>	Actual Power	par. 16-10 <i>Power [kW]</i> , par. 16-11 <i>Power [hp]</i>
Energy Cost per kWh	par. 23-81 <i>Energy Cost</i>	Cost Savings	par. 23-84 <i>Cost Savings</i>
Investment	par. 23-82 <i>Investment</i>		

23-80 Power Reference Factor

Range:	Function:
100 %* [0 - 100 %]	Set the percentage of the rated motor size (set in par. 1-20 <i>Motor Power [kW]</i> or par. 1-21 <i>Motor Power [HP]</i>) which is supposed to represent the average power yielded at the time running with fixed speed (before upgrade with variable speed control). Must be set to a value different from zero to start counting.

23-81 Energy Cost

Range:

1.00 N/A* [0.00 - 999999.99 N/A]

Function:

Set the actual cost for a kWh in local currency. If the energy cost is changed later on it will impact the calculation for the entire period!

23-82 Investment

Range:

0 N/A* [0 - 999999999 N/A]

Function:

Set the value of the investment spent on upgrading the plant with speed control, in same currency as used in par. 23-81 *Energy Cost*.

23-83 Energy Savings

Range:

0 kWh* [0 - 0 kWh]

Function:

This parameter allows a readout of the accumulated difference between the reference power and the actual output power.

If motor size set in Hp (par. 1-21 *Motor Power [HP]*), the equivalent kW value will be used for the Energy Savings.

23-84 Cost Savings

Range:

0 N/A* [0 - 2147483647 N/A]

Function:

This parameter allows a readout of the calculation based on the above equation (in local currency).

3.22 Main Menu - Application Functions 2 - Group 24

3.22.1 24-0* Fire Mode

NB!

Please note the frequency converter is only one component of the VLT HVAC Drive system. Correct function of Fire Mode depends on the correct design and selection of system components. Ventilation systems working in life safety applications have to be approved by the local fire Authorities. ***Non-interruption of the frequency converter due to Fire Mode operation may cause over pressure and result in damage to VLT HVAC Drive system and components, hereunder dampers and air ducts. The frequency converter itself may be damaged and it may cause damage or fire. Danfoss accepts no responsibility for errors, mal-functions personal injury or any damage to the frequency converter itself or components herein, VLT HVAC Drive systems and components herein or other property when the frequency converter has been programmed for Fire Mode. In no event shall Danfoss be liable to the end user or any other party for any direct or indirect, special or consequential damage or loss suffered by such party, which has occurred due to the frequency converter being programmed and operated in Fire Mode***

Background

Fire Mode is for use in critical situations, where it is imperative for the motor to keep running, regardless of the frequency converter's normal protective functions. These could be ventilation fans in tunnels or stairwells for instance, where continued operation of the fan facilitates safe evacuation of personnel in the event of a fire. Some selections of Fire Mode Function cause alarms and trip conditions to be disregarded, enabling the motor to run without interruption.

Activation

Fire Mode is activated only via Digital Input terminals. See par. 5-1* Digital Inputs.

Messages in display

When Fire Mode is activated, the display will show a status message "Fire Mode" and a warning "Fire Mode".

Once the Fire Mode is again deactivated, the status messages will disappear and the warning will be replaced by the warning "Fire M Was Active". This message can only be reset by power-cycling the frequency converter supply. If, whilst the frequency converter is active in Fire Mode, a warranty-affecting alarm (see par. 24-09 *Fire Mode Alarm Handling*) should occur, display will show the warning "Fire M Limits Exceeded".

Digital and relay outputs can be configured for the status messages "Fire Mode Active" and the warning "Fire M Was Active". See par. 5-3* and par. 5-4*.

"Fire M was Active" messages can also be accessed in the warning word via serial communication. (See relevant documentation).

The status messages "Fire Mode" can be accessed via the extended status word.

Message	Type	LCP	Digital Out/Relay	Warning Word 2	Ext. Status Word 2
Fire Mode	Status	+	+		+ (bit 25)
Fire Mode	Warning	+			
Fire M was Active	Warning	+	+	+ (bit 3)	
Fire M Limits Exceeded	Warning	+	+		

3

Log

An overview of events related to Fire Mode can be viewed in the Fire Mode log, par. 18-1*, or via the Alarm Log button on the Local Control Panel.

The log will include up to 10 of the latest events. Warranty Affecting Alarms will have a higher priority as the two other types of events.

The log cannot be reset!

Following events are logged:

*Warranty affecting alarms (see par. 24-09 *Fire Mode Alarm Handling*, Fire Mode Alarm Handling)

*Fire Mode activated

*Fire Mode deactivated

All other alarms occurring while Fire Mode activated will be logged as usual.



NB!

During Fire Mode operation all stop commands to the frequency converter will be ignored, including Coast/Coast inverse and External Interlock. However, if your frequency converter incorporates "Safe-Stop", this function is still active. See Section "How to Order / Ordering Form Type Code"



NB!

If in Fire Mode it is desired to use the Live Zero function, then it will also be active for analog inputs other than that used for Fire Mode setpoint / feedback. Should the feedback to any of those other analog inputs be lost, for example a cable is burned, Live Zero function will operate. If this is undesirable then Live Zero function must be disabled for those other inputs.

Desired Live Zero function in case of missing signal when Fire Mode active, must be set in par. 6-02 *Fire Mode Live Zero Timeout Function*.

Warning for Live Zero will have a higher priority than the warning "Fire Mode"

24-00 Fire Mode Function

Option:

Function:

[0] *	Disabled	Fire Mode Function is not active.
[1]	Enabled - Run	In this mode the motor will continue to operate in a clockwise direction. Works only in Open Loop. Set par. par. 24-01 <i>Fire Mode Configuration</i> to Open Loop [0].
[2]	Enabled - Run Reverse	In this mode the motor will continue to operate in a counter-clockwise direction. Works only in Open Loop. Set par. par. 24-01 <i>Fire Mode Configuration</i> to Open Loop [0].
[3]	Enabled - Coast	Whilst this mode is enabled, the output is disabled and the motor is allowed to coast to stop.



NB!

In the above, alarms are produced or ignored in accordance with the selection in par. 24-09 *Fire Mode Alarm Handling*.

24-01 Fire Mode Configuration

Option:

Function:

[0] * Open Loop

When Fire Mode is active, the motor will run with a fixed speed based on a Reference set. Unit will be the same as selected in par. 0-02 *Motor Speed Unit*.

[3] Closed Loop

When Fire Mode is active, the build in PID controller will control the speed based on the set point and a feed back signal, selected in par. 24-07 *Fire Mode Feedback Source*. Unit to be selected in par. 24-02 *Fire Mode Unit*. If the motor also is controlled by the build in PID controller when in normal operation, the same transmitter can be used for both cases by selecting the same source.



NB!

The PID controller can be adjusted with par. 24-09 *Fire Mode Alarm Handling*, [2] Trip, All Alarms/Test.



NB!

If Enable-Run Reverse is selected in par. 24-00 *Fire Mode Function*, Closed Loop cannot be selected in par. 24-01 *Fire Mode Configuration*.

24-02 Fire Mode Unit

Option:

Function:

Select the desired unit when Fire Mode is active and running in Closed Loop.

[0] *

[1] %

[2] RPM

[3] Hz

[4] Nm

[5] PPM

[10] 1/min

[11] RPM

[12] Pulse/s

[20] l/s

[21] l/min

[22] l/h

[23] m³/s

[24] m³/min

[25] m³/h

[30] kg/s

[31] kg/min

[32] kg/h

[33] t/min

[34] t/h

[40] m/s

[41] m/min

[45] m

[60] °C

[70] mbar

[71] bar

[72] Pa

[73]	kPa
[74]	m WG
[75]	mm Hg
[80]	kW
[120]	GPM
[121]	gal/s
[122]	gal/min
[123]	gal/h
[124]	CFM
[125]	ft ³ /s
[126]	ft ³ /min
[127]	ft ³ /h
[130]	lb/s
[131]	lb/min
[132]	lb/h
[140]	ft/s
[141]	ft/min
[145]	ft
[160]	°F
[170]	psi
[171]	lb/in ²
[172]	in WG
[173]	ft WG
[174]	in Hg
[180]	HP

24-03 Fire Mode Min Reference

Range:

0 FireMo- [-999999.999 - par. 24-04 FireMo-
deUnit* deUnit]

Function:

Minimum value for the reference/set point (limiting the sum of value in par. 24-05 *Fire Mode Preset Reference* and value of signal on input selected in par. 24-06 *Fire Mode Reference Source*).
If running in Open loop when Fire Mode is active, the unit is chosen by the setting of par. 0-02 *Motor Speed Unit*. For closed loop, the unit is selected in par. 24-02 *Fire Mode Unit*.

24-04 Fire Mode Max Reference

Range:

50.000 Fire- [par. 24-03 - 999999.999 FireMo-
ModeUnit* deUnit]

Function:

Maximum value for the reference/set point (limiting the sum of value in par. 24-05 *Fire Mode Preset Reference* and value of signal on input selected in par. 24-06 *Fire Mode Reference Source*).
If running in Open loop when Fire Mode is active, the unit is chosen by the setting of par. 0-02 *Motor Speed Unit*. For closed loop, the unit is selected in par. 24-02 *Fire Mode Unit*.

24-05 Fire Mode Preset Reference

Range:

0.00 %* [-100.00 - 100.00 %]

Function:

Enter the required preset reference/set point as a percentage of the Fire Mode Max Reference set in par. 24-04 *Fire Mode Max Reference*. The set value will be added to the value represented by the signal on the analog input selected in par. 24-06 *Fire Mode Reference Source*.

24-06 Fire Mode Reference Source

Option:

Function:

Select the external reference input to be used for the Fire Mode. This signal will be added to the value set in par. 24-06 *Fire Mode Reference Source*.

- [0] * No function
- [1] Analog input 53
- [2] Analog input 54
- [7] Pulse input 29
- [8] Pulse input 33
- [20] Digital pot.meter
- [21] Analog input X30/11
- [22] Analog input X30/12
- [23] Analog Input X42/1
- [24] Analog Input X42/3
- [25] Analog Input X42/5

24-07 Fire Mode Feedback Source

Option:

Function:

Select the feed back input to be used for the Fire Mode feed back signal when Fire Mode is active. If the motor also is controlled by the built in PID controller when in normal operation, the same transmitter can be used for both cases by selecting the same source.

- [0] * No function
- [1] Analog input 53
- [2] Analog input 54
- [3] Pulse input 29
- [4] Pulse input 33
- [7] Analog input X30/11
- [8] Analog input X30/12
- [9] Analog Input X42/1
- [10] Analog Input X42/3
- [11] Analog Input X42/5
- [100] Bus feedback 1
- [101] Bus feedback 2
- [102] Bus feedback 3

24-09 Fire Mode Alarm Handling

Option:

Function:

- [0] Trip+Reset, Critical Alarms
If this mode is selected, the frequency converter will continue to run, ignoring most alarms, EVEN IF DOING SO MAY RESULT IN DAMAGE OF THE FREQUENCY CONVERTER. Critical alarms are alarms, which cannot be suppressed but a restart attempt is possible (Infinity Automatic Reset).
- [1] * Trip, Critical Alarms
In case of a critical alarm, the frequency converter will trip and not auto-restart (Manual Reset).
- [2] Trip, All Alarms/Test
It is possible to test the operation of Fire Mode, but all alarm states are activated normally (Manual Reset).

**NB!**

Warranty-affecting alarms. Certain alarms can affect the lifetime of the frequency converter. Should one of these ignored alarms occur whilst in Fire Mode, a log of the event is stored in the Fire Mode Log.

Here the 10 latest events of warranty-affecting alarms, fire mode activation and fire mode deactivation are stored.

**NB!**

The setting in par. 14-20 *Reset Mode* is disregarded in case of Fire Mode being active (see par. 24-0*, Fire Mode).

No:	Description	Critical Alarms	Warranty Affecting Alarms
4	Mains ph. Loss		x
7	DC over volt	x	
8	DC under volt	x	
9	Inverter overloaded		x
13	Over current	x	
14	Earth fault	x	
16	Short circuit	x	
29	Power card temp		x
33	Inrush fault		x
38	Internal fault		x
65	Ctrl. card temp		x
68	SafeStop	x	

3.22.2 24-1* Drive Bypass

The frequency converter includes a feature, which can be used to automatically activate an external electro-mechanical bypass in case of a trip/trip lock of the frequency converter or the event of a Fire Mode Coast (see par. 24-00 *Fire Mode Function*).

The bypass will switch the motor to operation direct on line. The external bypass is activated by means of one of the digital outputs or relays in the frequency converter, when programmed in par. 5-3* or par. 5-4*.

**NB!**

Important! After enabling the Drive Bypass Function, the frequency converter is no longer Safety Certified (for using the Safe Stop in versions, where included).

To deactivate the Drive Bypass at normal operation (Fire Mode not activated), one of following actions must be carried out:

- Press the Off button on the Local Control Panel, LCP, (or program two of the digital inputs for Hand On-Off-Auto).
- Activate External Interlock via digital input
- Carry out a Power Cycling.

**NB!**

The Drive Bypass cannot be deactivated if in Fire Mode. It can be deactivated only by either removing the Fire Mode command signal or the power supply to the frequency converter!

When the Drive Bypass function is activated, the display on the Local Control Panel will show the status message Drive Bypass. This message has a higher priority than the Fire Mode status messages. When the automatic Drive Bypass function is enabled, it will cut in the external bypass according to the below sequence:

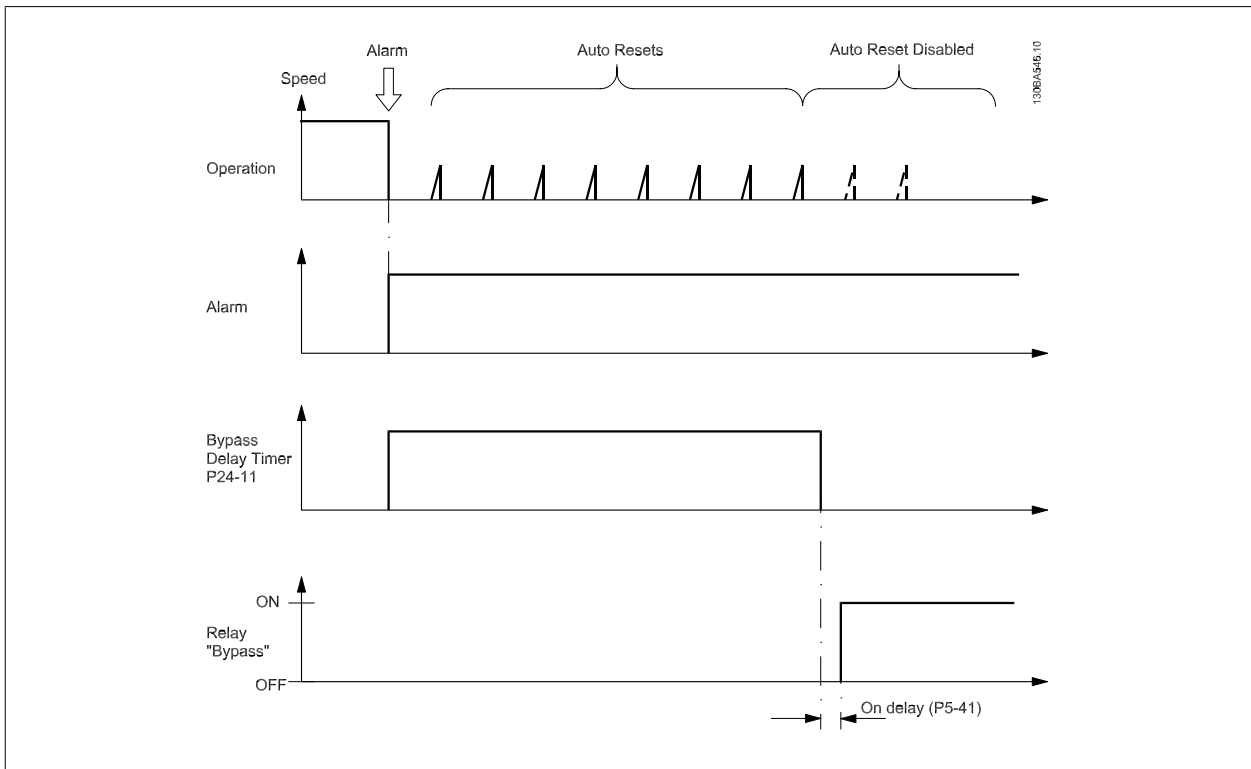

Status can be read in the Extended Status Word 2, bit number 24.

24-10 Drive Bypass Function

Option:

Function:

This parameter determines, what circumstances will activate the Drive Bypass Function:

[0] * Disabled

[1] Enabled

If in normal operation the automatic Drive Bypass Function will be activated at following conditions:
 At a Trip Lock or a Trip. After the programmed number of reset attempts, programmed in par. 14-20 *Reset Mode* or if the Bypass Delay Timer (par. 24-11 *Drive Bypass Delay Time*) expires before reset attempts have been completed

When in Fire Mode, the Bypass Function will operate under following conditions:

When experiencing a trip at critical alarms, a Coast or if the Bypass Delay Timer expires before reset attempts have completed when [2] Enabled in Fire Mode. The Bypass Function will operate at trip at critical alarms, Coast or if the Bypass Delay Timer expires before reset attempts have been completed.

[2] Enabled (Fire M Only)

The Bypass Function will operate at Trip at Critical Alarms, Coast or Bypass Delay Timer if the timer expires before reset attempts have completed.



NB!

Important! After enabling the Drive Bypass Function, the Safe Stop function (in versions, where included) is not complying with standard EN 954-1, Cat. 3 installations anymore.

24-11 Drive Bypass Delay Time

Range:

0 s* [0 - 600 s]

Function:

Programmable in 1 s increments. Once the Bypass Function is activated in accordance with the setting in par. 24-10 *Drive Bypass Function*, the Bypass Delay Timer begins to operate. If the frequency converter has been set for a number of restart attempts, the timer will continue to run while the frequency converter tries to restart. Should the motor have restarted within the time period of the Bypass Delay Timer, then the timer is reset.

Should the motor fail to restart at the end of the Bypass Delay Time, the Drive Bypass relay will be activated, which will have been programmed for Bypass in par. 5-40 *Function Relay*. If a [Relay Delay] has also been programmed in par. 5-41 *On Delay, Relay, [Relay]* or par. 5-42 *Off Delay, Relay, [Relay]*, then this time must also elapse before the relay action is performed.

Where no restart attempts are programmed, the timer will run for the delay period set in this parameter and will then activate the Drive Bypass relay, which will have been programmed for Bypass in par. 5-40 *Function Relay, Function Relay*. If a Relay Delay has also been programmed in par. 5-41 *On Delay, Relay, On Delay, Relay* or par. 5-42 *Off Delay, Relay, [Relay]*, then this time must also elapse before the relay action is performed.

3

3.23 Main Menu - Cascade Controller - Group 25

3.23.1 25-** Cascade Controller

Parameters for configuring the Basic Cascade Controller for sequence control of multiple pumps. For a more application oriented description and wiring examples, see section *Application Examples, Basic Cascade Controller*.

To configure the Cascade Controller to the actual system and the desired control strategy, it is recommended to follow the below sequence, starting with par. 25-0* *System Settings* and next par. 25-5* *Alternation Settings*. These parameter can normally be set in advance.

Parameters in 25-2* *Bandwidth Settings* and 25-4* *Staging settings*, will often be dependent on the dynamic of the system and final adjustment to be done at the commissioning of the plant.

NB!

The Cascade Controller is supposed to operate in closed loop controlled by the built-in PI controller (Closed Loop selected in *Configuration Mode*, par. 1-00 *Configuration Mode*). If *Open Loop* is selected in par. 1-00 *Configuration Mode*, all fixed speed pumps will be destaged, but the variable speed pump will still be controlled by the frequency converter, now as an open loop configuration:

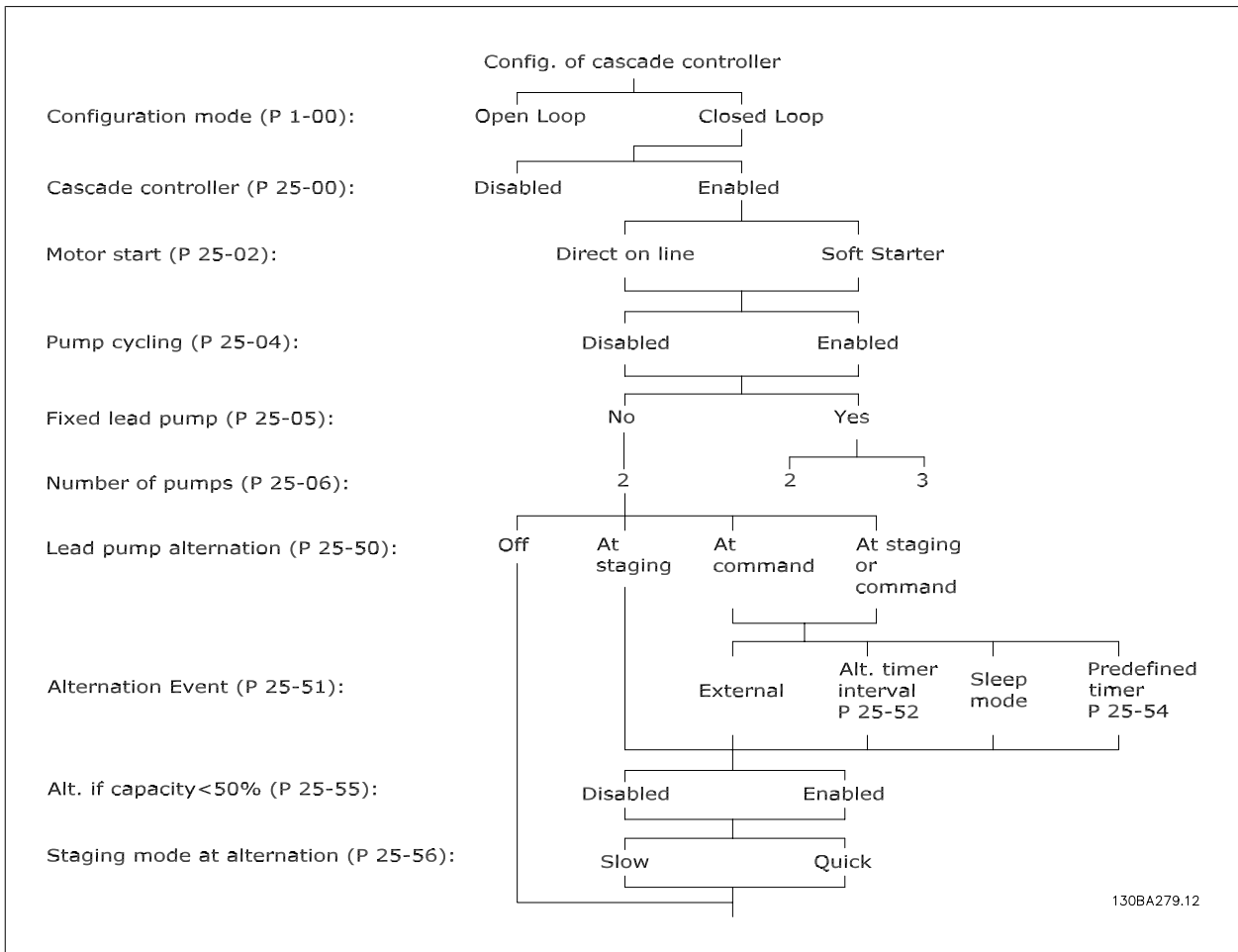

3.23.2 25-0* System Settings

Parameters related to control principles and configuration of the system.

25-00 Cascade Controller

Option:

Function:

For operation of multiple devices (pump/fan) systems where capacity is adapted to actual load by means of speed control combined with on/off control of the devices. For simplicity only pump systems are described.

[0] * Disabled

The Cascade Controller is not active. All built-in relays assigned to pump motors in the cascade function will be de-energized. If a variable speed pump is connected to the frequency converter directly (not controlled by a built-in relay); this pump/fan will be controlled as a single pump system.

[1] Enabled

25-02 Motor Start

Option:

Function:

Motors are connected to the mains directly with a contactor or with a soft starter. When the value of par. 25-02 *Motor Start* is set to an option other than *Direct on Line* [0], then par. 25-50 *Lead Pump Alternation* is automatically set to the default of *Direct on Line* [0].

[0] * Direct on Line

Each fixed speed pump is connected to line directly via a contactor.

[1] Soft Starter

Each fixed speed pump is connected to line via a soft starter.

[2] Star-Delta

25-04 Pump Cycling

Option:
Function:

To provide equal hours of operation with fixed speed pumps, the pump use can be cycled. The selection of pump cycling is either "first in – last out" or equal running hours for each pump.

[0] * Disabled

The fixed speed pumps will be connected in the order 1 – 2 and disconnected in the order 2 – 1. (First in – last out).

[1] Enabled

The fixed speed pumps will be connected/disconnected to have equal running hours for each pump.

25-05 Fixed Lead Pump

Option:
Function:

Fixed Lead Pump means that the variable speed pump is connected directly to the frequency converter and if a contactor is applied between frequency converter and pump, this contactor will not be controlled by the frequency converter.

If operating with par. 25-50 *Lead Pump Alternation* set to other than *Off*[0], this parameter must be set to *No*[0].

[0] No

The lead pump function can alternate between the pumps controlled by the two built in relays. One pump must be connected to the built-in RELAY 1, and the other pump to RELAY 2. The pump function (Cascade Pump1 and Cascade Pump2) will automatically be assigned to the relays (maximum two pumps can in this case be controlled from the frequency converter).

[1] * Yes

The lead pump will be fixed (no alternation) and connected directly to the frequency converter. The par. 25-50 *Lead Pump Alternation* is automatically set to *Off*[0]. Built-in relays Relay 1 and Relay 2 can be assigned to separate fixed speed pumps. In total three pumps can be controlled by the frequency converter.

25-06 Number of Pumps

Range:
Function:

2 N/A* [2 - 9. N/A]

The number of pumps connected to the Cascade Controller including the variable speed pump. If the variable speed pump is connected directly to the frequency converter and the other fixed speed pumps (lag pumps) are controlled by the two built in relays, three pumps can be controlled. If both the variable speed and fixed speed pumps are to be controlled by built-in relays, only two pumps can be connected.

If par. 25-05 *Fixed Lead Pump, Fixed Lead Pump*, is set to *No*[0]: one variable speed pump and one fixed speed pump; both controlled by built in relay. If par. 25-05 *Fixed Lead Pump, Fixed Lead Pump*, is set to *Yes*[1]: one variable speed pump and one fixed speed pump controlled by built-in relay.

One lead pump, see par. 25-05 *Fixed Lead Pump*. Two fixed speed pumps controlled by built-in relays.

3.23.3 25-2* Bandwidth Manager

Parameters for setting the bandwidth within which the pressure will be allowed to operate before staging/destaging fixed speed pumps. Also includes various timers to stabilize the control.

25-20 Staging Bandwidth

Range:
Function:

10 %* [1 - par. 25-21 %]

25-21 Override Bandwidth

Range:
Function:

100 %* [par. 25-20 - 100 %]

When a large and quick change in the system demand occurs (such as a sudden water demand), the system pressure rapidly changes and an immediate staging or destaging of a fixed speed pump

becomes necessary to match the requirement. The override bandwidth (OBW) is programmed to override the staging/destaging timer (par. 25-23 *SBW Staging Delay* and par. 25-24 *SBW Destaging Delay*) for immediate response.

The OBW must always be programmed to a higher value than the value set in *Staging Bandwidth* (SBW), par. 25-20 *Staging Bandwidth*. The OBW is a percentage of par. and par. .

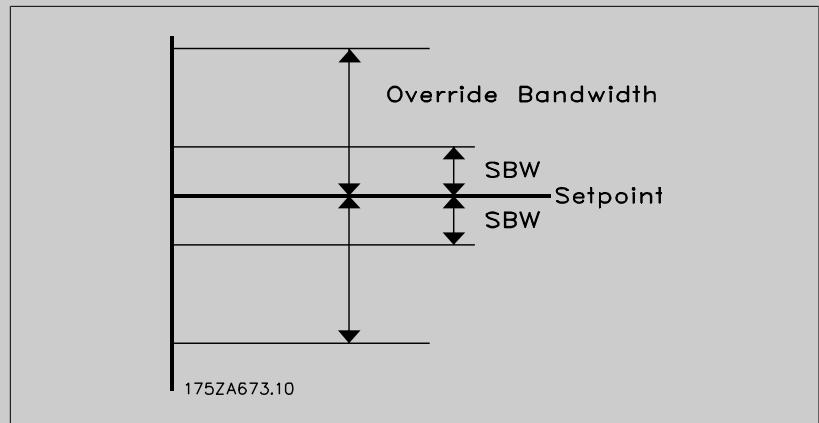

Setting the OBW too close to the SBW could defeat the purpose with frequent staging at momentary pressure changes. Setting the OBW too high might lead to unacceptably high or low pressure in the system while the SBW timers are running. The value can be optimized with increased familiarity with the system. See par. 25-25 *OBW Time*.

To avoid unintended staging during the commissioning phase and fine tuning of the controller, initially leave the OBW at the factory setting of 100% (Off). When the fine tuning is completed, the OBW should be set to the desired value. An initial value of 10% is suggested.

25-22 Fixed Speed Bandwidth

Range:

par. 25-20 [par. 25-20 - par. 25-21 %]
%*

Function:

When the cascade control system is running normally and the frequency converter issues a trip alarm, it is important to maintain the system head. The Cascade Controller does this by continuing to stage/destage the fixed speed pump on and off. Due to the fact that keeping the head at the setpoint would require frequent staging and destaging when only a fixed speed pump is running, a wider Fixed Speed Bandwidth (FSBW) is used instead of SBW. It is possible to stop the fixed speed pumps, in case of an alarm situation, by pressing the LCP OFF or HAND ON keys or if the signal programmed for Start on digital input goes low.

In case the issued alarm is a trip-lock alarm then the Cascade Controller must stop the system immediately by cutting out all the fixed speed pumps. This is basically the same as Emergency Stop (Coast/Coast inverse Command) for the Cascade Controller.

25-23 SBW Staging Delay

Range:

15 s* [0 - 3000 s]

Function:

Immediate staging of a fixed speed pump is not desirable when a momentary pressure drop in the system exceeds the Staging Bandwidth (SBW). Staging is delayed by the length of time programmed. If the pressure increases to within the SBW before the timer has elapsed, the timer is reset.

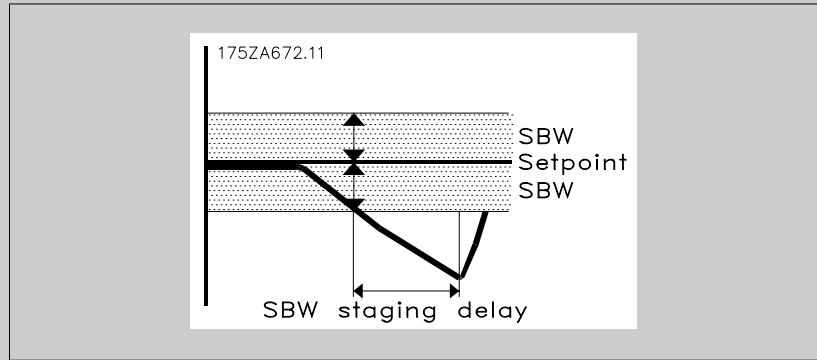

25-24 SBW Destaging Delay

Range:

15 s* [0 - 3000 s]

Function:

Immediate destaging of a fixed speed pump is not desirable when a momentary pressure increase in the system that exceeds the Staging Bandwidth (SBW). Destaging is delayed by the length of time programmed. If the pressure decreases to within the SBW before the timer has elapsed, the timer is reset.

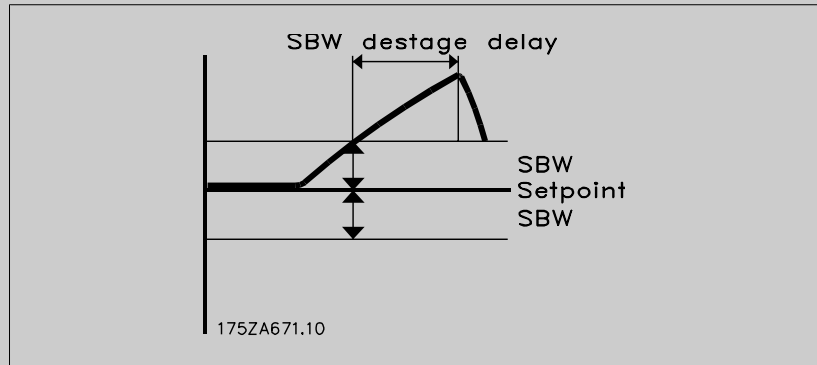

25-25 OBW Time

Range:

10 s* [0 - 300 s]

Function:

Staging a fixed speed pump creates a momentary pressure peak in the system, which might exceed the Override Bandwidth (OBW). It is not desirable to destage a pump in response to a staging pressure peak. The OBW Time can be programmed to prevent staging until the system pressure has stabilized and normal control established. Set the timer to a value that allows the system to stabilize after staging. The 10 second factory setting is appropriate in most applications. In highly dynamic systems, a shorter time may be desirable.

25-30 Destage Function Time**Range:**

15 s* [0 - 300 s]

Function:

The Destage Function Timer is programmable to avoid frequent staging/destaging of the fixed speed pumps. The Destage Function Time starts when the adjustable speed pump is running at par. 4-11 *Motor Speed Low Limit [RPM]* or par. 4-12 *Motor Speed Low Limit [Hz]*, with one or more fixed speed pumps in operation and system requirements satisfied. In this situation, the adjustable speed pump contributes a little to the system. When the programmed value of the timer expires, a stage is removed, avoiding dead head water circulation in the adjustable speed pump.

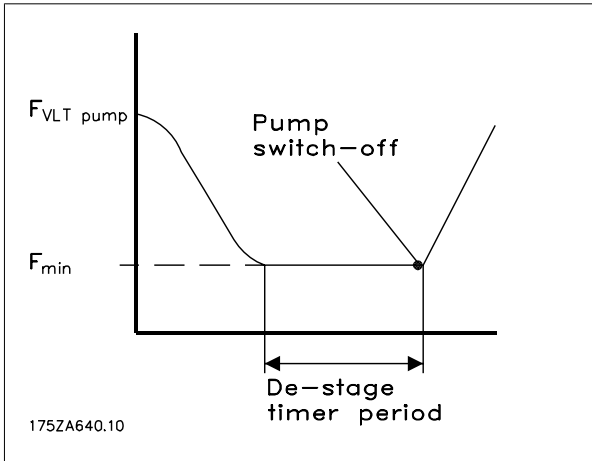
**3.23.4 25-4* Staging Settings**

Parameters determining conditions for staging/destaging the pumps.

25-40 Ramp Down Delay**Range:**

10.0 s* [0.0 - 120.0 s]

Function:

When adding a fixed speed pump controlled by a soft starter, it is possible to delay the ramp down of the lead pump until a preset time after the start of the fixed speed pump to eliminate pressure surges or water hammer in the system.

Only to be used if *Soft Starter* [1] is selected in par. 25-02 *Motor Start*.

25-41 Ramp Up Delay**Range:**

2.0 s* [0.0 - 12.0 s]

Function:

When removing a fixed speed pump controlled by a soft starter, it is possible to delay the ramp up of the lead pump until a preset time after the stopping of the fixed speed pump to eliminate pressure surges or water hammer in the system.

Only to be used if *Soft Starter* [1] is selected in par. 25-02 *Motor Start*.

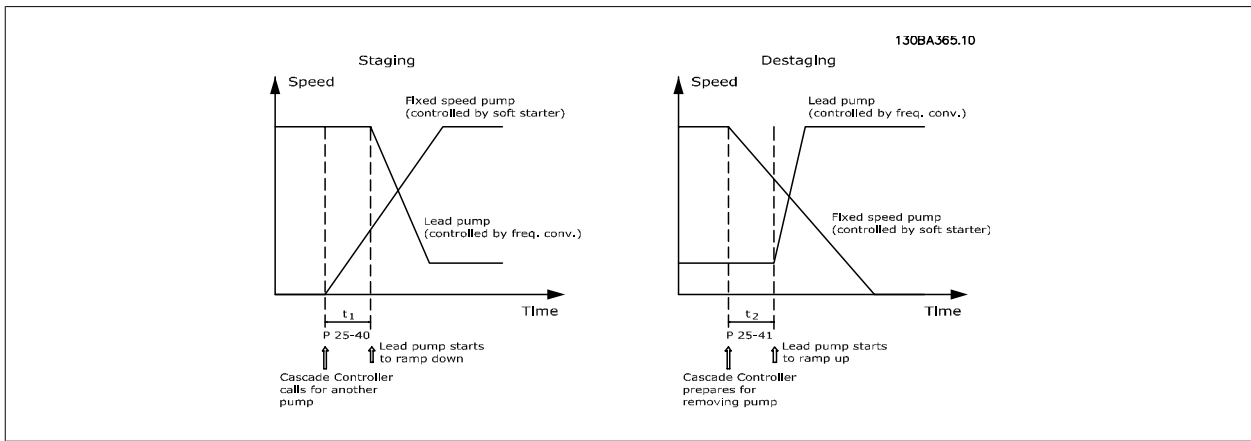

25-42 Staging Threshold

Range:

0 %* [0 - 100 %]

Function:

When adding a fixed speed pump, in order to prevent an overshoot of pressure, the variable speed pump ramps down to a lower speed. When the variable speed pump reaches the "Staging Speed" the fixed speed pump is staged on. The Staging Threshold is used to calculate the speed of the variable speed pump when the "cut-in point" of the fixed speed pump occurs. The calculation of the Staging Threshold is the ratio of par. 4-11 *Motor Speed Low Limit [RPM]* or par. 4-12 *Motor Speed Low Limit [Hz]*, to the par. 4-13 *Motor Speed High Limit [RPM]* or par. 4-14 *Motor Speed High Limit [Hz]*, expressed in percent.

Staging Threshold must range from $STAGE\% = \frac{LOW}{HIGH} \times 100\%$

to 100%, where n_{LOW} is Motor Speed Low Limit and n_{HIGH} is Motor Speed High Limit.

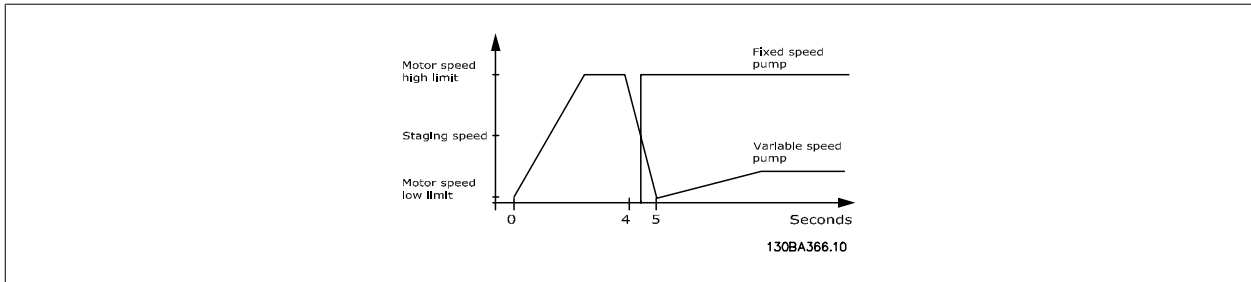

25-43 Destaging Threshold

Range:

0 %* [0 - 100 %]

Function:

When removing a fixed speed pump, in order to prevent an undershoot of pressure, the variable speed pump ramps up to a higher speed. When the variable speed pump reaches the "Destaging Speed" the fixed speed pump is destaged. The Destaging Threshold is used to calculate the speed of the variable speed pump when the destaging of the fixed speed pump occurs. The calculation of the Destaging Threshold is the ratio of par. 4-11 *Motor Speed Low Limit [RPM]* or par. 4-12 *Motor Speed Low Limit [Hz]*, to the par. 4-13 *Motor Speed High Limit [RPM]* or par. 4-14 *Motor Speed High Limit [Hz]*, expressed in percent.

Destaging Threshold must range from $STAGE\% = \frac{LOW}{HIGH} \times 100\%$ to 100%, where n_{LOW} is

Motor Speed Low Limit and n_{HIGH} is Motor Speed High Limit.

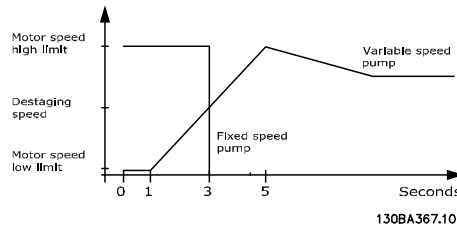

3

25-44 Staging Speed [RPM]

Range:

0 RPM* [0 - 0 RPM]

Function:

Readout of the below calculated value for Staging Speed. When adding a fixed speed pump, in order to prevent an overshoot of pressure, the variable speed pump ramps down to a lower speed. When the variable speed pump reaches the "Staging Speed" the fixed speed pump is staged on. Staging Speed calculation is based on par. 25-42 *Staging Threshold*, and par. 4-13 *Motor Speed High Limit [RPM]*.

Staging Speed is calculated with the following formula:

$$STAGE = HIGH \frac{STAGE\%}{100}$$

where n_{HIGH} is Motor Speed High Limit and n_{STAGE100%} is the value of Staging Threshold.

25-45 Staging Speed [Hz]

Range:

0.0 Hz* [0.0 - 0.0 Hz]

Function:

Readout of the below calculated value for Staging Speed. When adding a fixed speed pump, in order to prevent an overshoot of pressure, the variable speed pump ramps down to a lower speed. When the variable speed pump reaches the "Staging Speed" the fixed speed pump is staged on. Staging Speed calculation is based on par. 25-42 *Staging Threshold*, and par. 4-14 *Motor Speed High Limit [Hz]*.

Staging Speed is calculated with the following formula:

$$STAGE = HIGH \frac{STAGE\%}{100}$$

where n_{HIGH} is Motor Speed High Limit and n_{STAGE100%} is the value of Staging Threshold.

25-46 Destaging Speed [RPM]

Range:

0 RPM* [0 - 0 RPM]

Function:

Readout of the below calculated value for Destaging Speed. When removing a fixed speed pump, in order to prevent an undershoot of pressure, the variable speed pump ramps up to a higher speed. When the variable speed pump reaches the "Destaging Speed" the fixed speed pump is destaged. Destaging Speed is calculated based on par. 25-43 *Destaging Threshold*, and par. 4-13 *Motor Speed High Limit [RPM]*.

Destaging Speed is calculated with the following formula:

$$DESTAGE = HIGH \frac{DESTAGE\%}{100}$$

where n_{HIGH} is Motor Speed High Limit and n_{DESTAGE100%} is the value of Destaging Threshold.

25-47 Destaging Speed [Hz]

Range:

0.0 Hz* [0.0 - 0.0 Hz]

Function:

Readout of the below calculated value for Destaging Speed. When removing a fixed speed pump, in order to prevent an undershoot of pressure, the variable speed pump ramps up to a higher speed. When the variable speed pump reaches the "Destaging Speed" the fixed speed pump is destaged. Destaging Speed is calculated based on par. 25-43 *Destaging Threshold*, and par. 4-14 *Motor Speed High Limit [Hz]*.

Destaging Speed is calculated with the following formula:

$$DESTAGE = HIGH \frac{DESTAGE\%}{100}$$

where n_{HIGH} is Motor Speed High Limit and n_{DESTAGE100%} is the value of Destaging Threshold.

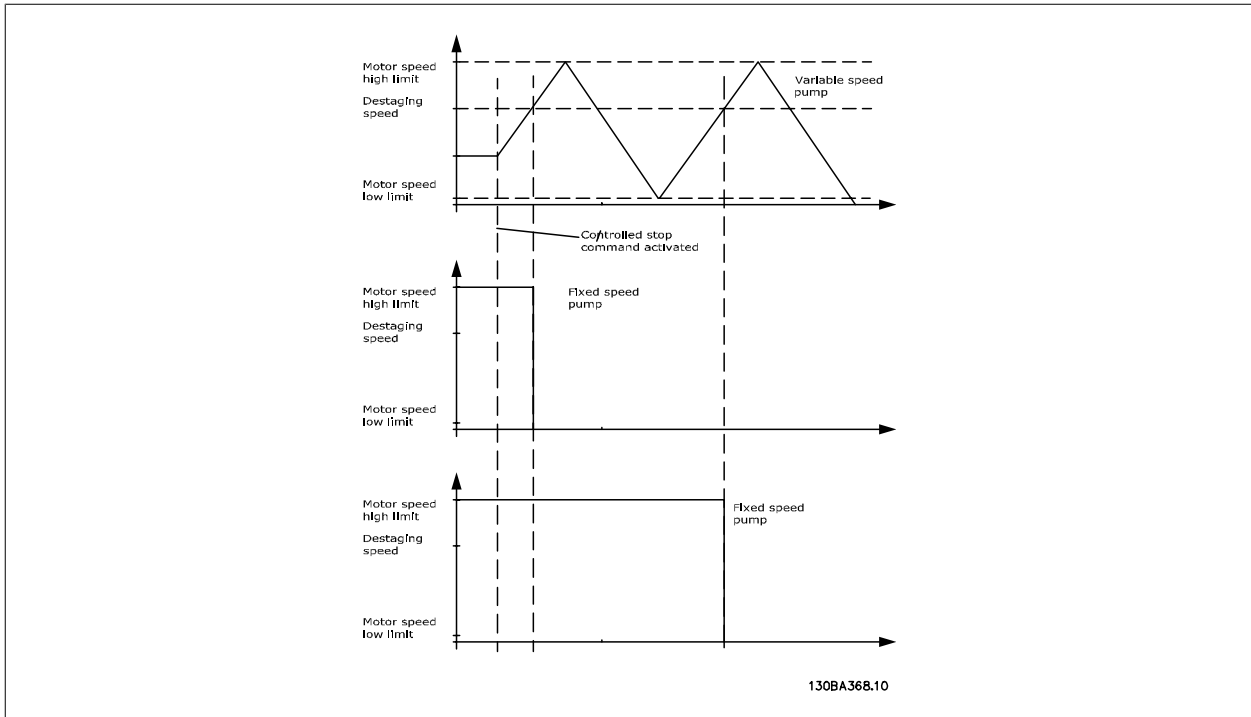

3.23.5 25-5* Alternation Settings

Parameters for defining the conditions for alternation of the variable speed pump (lead), if selected as part of the control strategy.

25-50 Lead Pump Alternation

Option:

Function:

Lead pump alternation equalizes the use of pumps by periodically changing the pump that is speed controlled. This ensures that pumps are equally used over time. Alternation equalizes the usage of pumps by always choosing the pump with the lowest number of used hours to stage on next.

[0] * Off

No alternation of lead pump function will take place. It is not possible to set this parameter to options other than *Off*[0] if par. 25-02 *Motor Start* is set other than *Direct on Line* [0].

[1] At staging

Alternation of the lead pump function will take place when staging another pump.

[2] At command

Alternation of the lead pump function will take place at an external command signal or a pre-programmed event. See par. 25-51 *Alternation Event* for available options.

[3] At staging or command

Alternation of the variable speed (lead) pump will take place at staging or the "At Command" signal. (See above.)

**NB!**

It is not possible to select other than *Off*[0] if par. 25-05 *Fixed Lead Pump* is set to *Yes*[1].

3

25-51 Alternation Event**Option:****Function:**

This parameter is only active if the options *At Command* [2] or *At Staging or Command* [3] have been selected in par. 25-50 *Lead Pump Alternation*. If an Alternation Event is selected, the alternation of lead pump takes place every time the event occurs.

[0] * External

Alternation takes place when a signal is applied to one of the digital inputs on the terminal strip and this input has been assigned to *Lead Pump Alternation* [121] in par. 5-1*, *Digital Inputs*.

[1] Alternation Time Interval

Alternation takes place every time par. 25-52 *Alternation Time Interval*, expires.

[2] Sleep Mode

Alternation takes place each time the lead pump goes into sleep mode. par. 20-23 *Setpoint 3* must be set to *Sleep Mode* [1] or an external signal applied for this function.

[3] Predefined Time

Alternation takes place at a defined time of the day. If par. 25-54 *Alternation Predefined Time*, is set, the alternation is carried out every day at the specified time. Default time is midnight (00:00 or 12:00AM depending on the time format).

25-52 Alternation Time Interval**Range:****Function:**

24 h* [1 - 999 h]

If *Alternation Time Interval* [1] option in par. 25-51 *Alternation Event*, is selected, the alternation of the variable speed pump takes place every time the Alternation Time Interval expires (can be checked out in par. 25-53 *Alternation Timer Value*).

25-53 Alternation Timer Value**Range:****Function:**

0 N/A* [0 - 0 N/A]

Readout parameter for the Alternation Time Interval value set in par. 25-52 *Alternation Time Interval*.

25-54 Alternation Predefined Time**Range:****Function:**

0 N/A* [0 - 0 N/A]

If option *Predefined Time* [3] in par. 25-51 *Alternation Event*, is selected, the variable speed pump alternation is carried out every day at the specified time set in Alternation Predefined Time. Default time is midnight (00:00 or 12:00AM depending on the time format).

25-55 Alternate if Load < 50%**Option:****Function:**

If Alternation If Capacity <50% is enabled, the pump alternation can only occurs if the capacity is equal to or below 50%. The capacity calculation is the ratio of running pumps (including the variable speed pump) to the total number of available pumps (including variable speed pump, but not those interlocked).

$$Capacity = \frac{N_{RUNNING}}{N_{TOTAL}} \times 100\%$$

For the Basic Cascade Controller all pumps are equal size.

[0] Disabled

The lead pump alternation will take place at any pump capacity.

[1] * Enabled

The lead pump function will be alternated only if the numbers of pumps running are providing less than 50% of total pump capacity.



NB!

Only valid if par. 25-50 *Lead Pump Alternation* is different from *Off*[0].

25-56 Staging Mode at Alternation

Option:

Function:

This parameter is only active if the option selected in par. 25-50 *Lead Pump Alternation* is different from *Off*[0].

Two types of staging and destaging of pumps are possible. Slow transfer makes staging and destaging smooth. Quick Transfer makes staging and destaging as fast as possible; the variable speed pump is just cut out (coasted).

[0] * Slow

At alternation, the variable speed pump is ramped up to maximum speed and then ramped down to a stand still.

[1] Quick

At alternation, the variable speed pump is ramped up to maximum speed and then coasted to stand still.

The below figure is an example of the Slow transfer staging. The variable speed pump (top graph) and one fixed speed pump (bottom graph) are running before the staging command. When the *Slow* [0] transfer command is activated, an alternation is carried out by ramping the variable speed pump to par. 4-13 *Motor Speed High Limit [RPM]* or par. 4-14 *Motor Speed High Limit [Hz]*, and then decelerated to zero speed. After a "Delay Before Starting Next Pump" (par. 25-58 *Run Next Pump Delay*) the next lead pump (middle graph) is accelerated and another original lead pump (top graph) is added after the "Delay Before Running On Mains" (par. 25-59 *Run on Mains Delay*) as a fixed speed pump. The next lead pump (middle graph) is decelerated to Motor Speed Low Limit and then allowed to vary speed to maintain system pressure.

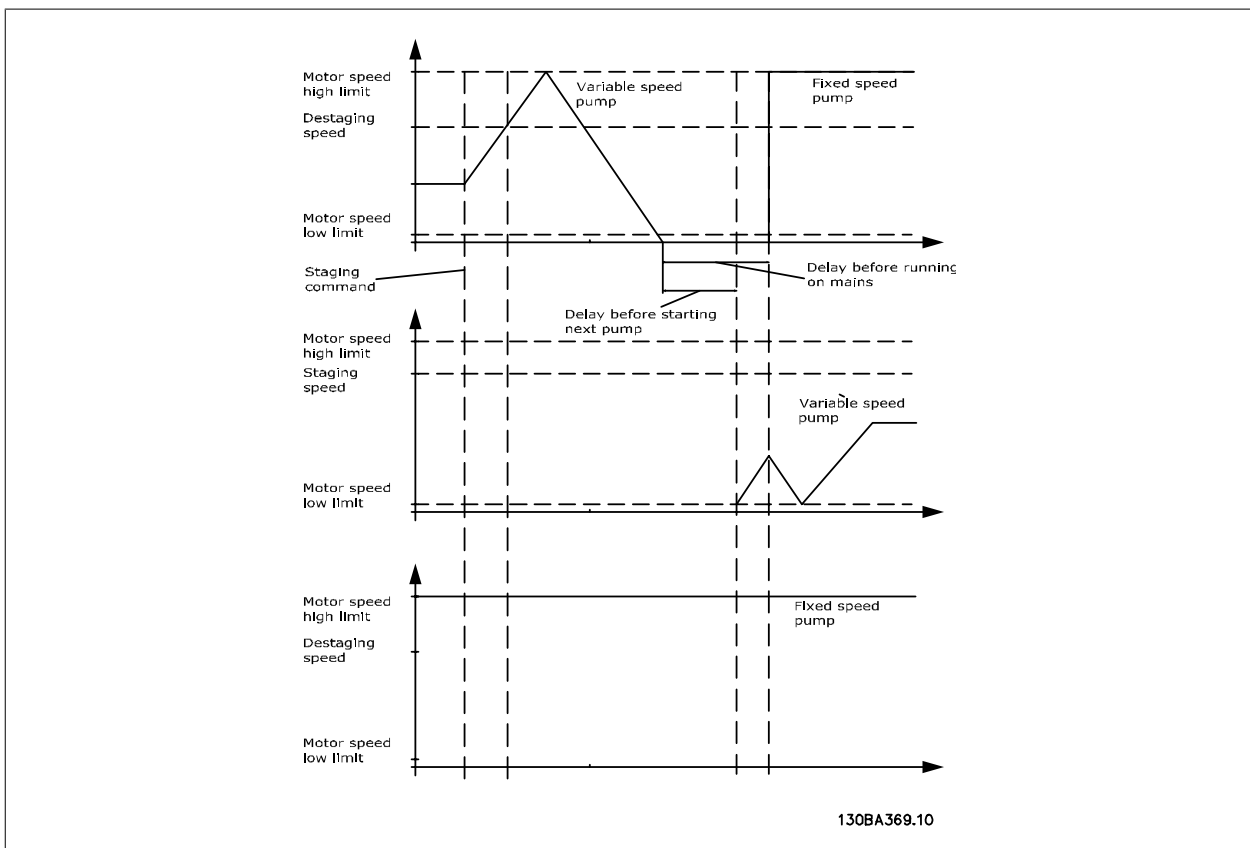

25-58 Run Next Pump Delay

Range:

0.1 s* [0.1 - 5.0 s]

Function:

This parameter is only active if the option selected in par. 25-50 *Lead Pump Alternation*, is different from *Off*[0].

This parameter sets the time between stopping the old variable speed pump and starting another pump as a new variable speed pump. Refer to par. 25-56 *Staging Mode at Alternation*, the illustration for description of staging and alternation.

25-59 Run on Mains Delay

Range:

0.5 s* [par. 25-58 - 5.0 s]

Function:

This parameter is only active if the option selected in par. 25-50 *Lead Pump Alternation*, is different from *Off*[0].

This parameter sets the time between stopping the old variable speed pump and starting this pump as a new fixed speed pump. Refer to par. 25-56 *Staging Mode at Alternation*, the illustration for description of staging and alternation.

3.23.6 25-8* Status

Readout parameters informing about the operating status of the cascade controller and the pumps controlled.

25-80 Cascade Status

Range:

0 N/A* [0 - 0 N/A]

Function:

Read out of the status of the Cascade Controller.

25-81 Pump Status

Range:

0 N/A* [0 - 0 N/A]

Function:

Pump Status shows the status for the number of pumps selected in par. 25-06 *Number of Pumps*. It is a readout of the status for each of the pumps showing a string, which consists of pump number and the current status of the pump.

Example: Readout is with the abbreviation like "1:D 2:O" This means that pump 1 is running and speed controlled by the frequency converter and pump 2 is stopped.

25-82 Lead Pump

Range:

0 N/A* [0 - par. 25-06 N/A]

Function:

Readout parameter for the actual variable speed pump in the system. The Lead Pump parameter is updated to reflect the current variable speed pump in the system when an alternation takes place. If no lead pump is selected (Cascade Controller disabled or all pumps interlocked) the display will show NONE.

25-83 Relay Status

Array [2]

Range:

0 N/A* [0 - 0 N/A]

Function:

Read out of the status for each of the relays assigned to control the pumps. Every element in the array represents a relay. If a relay is activated, the corresponding element is set to "On". If a relay is deactivated, the corresponding element is set to "Off".

25-84 Pump ON Time

Array [2]

Range:

0 h* [0 - 2147483647 h]

Function:

Readout of the value for Pump ON Time. The Cascade Controller has separate counters for the pumps and for the relays that control the pumps. Pump ON Time monitors the "operating hours" of each pump. The value of each Pump ON Time counter can be reset to 0 by writing in the parameter, e.g. if the pump is replaced in case of service.

25-85 Relay ON Time

Array [2]

Range:

0 h* [0 - 2147483647 h]

Function:

Readout of the value for Relay ON time. The Cascade Controller has separate counters for the pumps and for the relays that control the pumps. Pump cycling is always done based on the relay counters, otherwise it would always use the new pump if a pump is replaced and its value in par. 25-84 *Pump ON Time* is reset. In order to use par. 25-04 *Pump Cycling* the Cascade Controller is monitoring the Relay ON time.

25-86 Reset Relay Counters**Option:**

[0] * Do not reset

[1] Do reset

Function:Resets all elements in par. 25-85 *Relay ON Time* counters.**3.23.7 25-9* Service**

Parameters used in case of service on one or more of the pumps controlled.

25-90 Pump Interlock

Array [2]

Option:

[0] * Off

[1] On

Function:

In this parameter, it is possible to disable one or more of the fixed lead pumps. For example, the pump will not be selected for staging on even if it is the next pump in the operation sequence. It is not possible to disable the lead pump with the Pump Interlock command.

The digital input interlocks are selected as *Pump 1-3 Interlock* [130 – 132] in par. 5-1*, *Digital Inputs*.

The pump is active for staging/destaging.

The Pump Interlock command is given. If a pump is running it is immediately destaged. If the pump is not running it is not allowed to stage on.

25-91 Manual Alternation**Range:**

0 N/A* [0 - par. 25-06 N/A]

Function:

Readout parameter for the actual variable speed pump in the system. The Lead Pump parameter is updated to reflect the current variable speed pump in the system when an alternation takes place. If no lead pump is selected (Cascade Controller disabled or all pumps interlocked) the display will show NONE.

3.24 Main Menu - Analog I/O Option MCB 109 - Group 26**3.24.1 Analog I/O Option MCB 109, 26-****

The Analog I/O Option MCB 109 extends the functionality of VLT HVAC Drive frequency converters, by adding a number of additional, programmable analog inputs and outputs. This could be especially useful in Building Management System installations where the frequency converter may be used as de-central I/O, obviating the need for an outstation and thus reducing cost.

Consider the diagram:

3

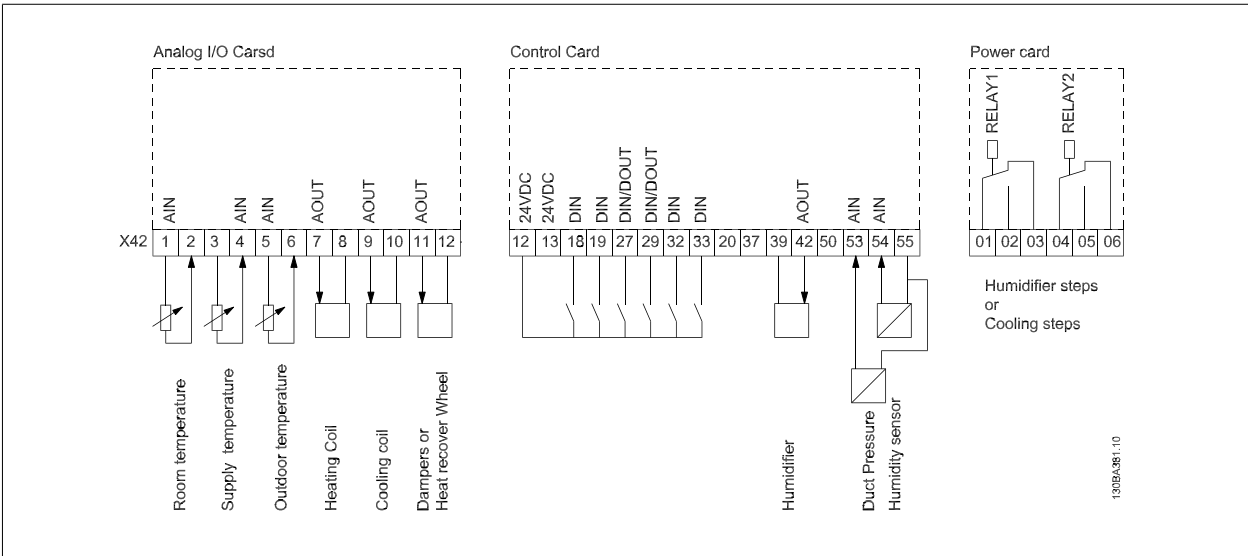
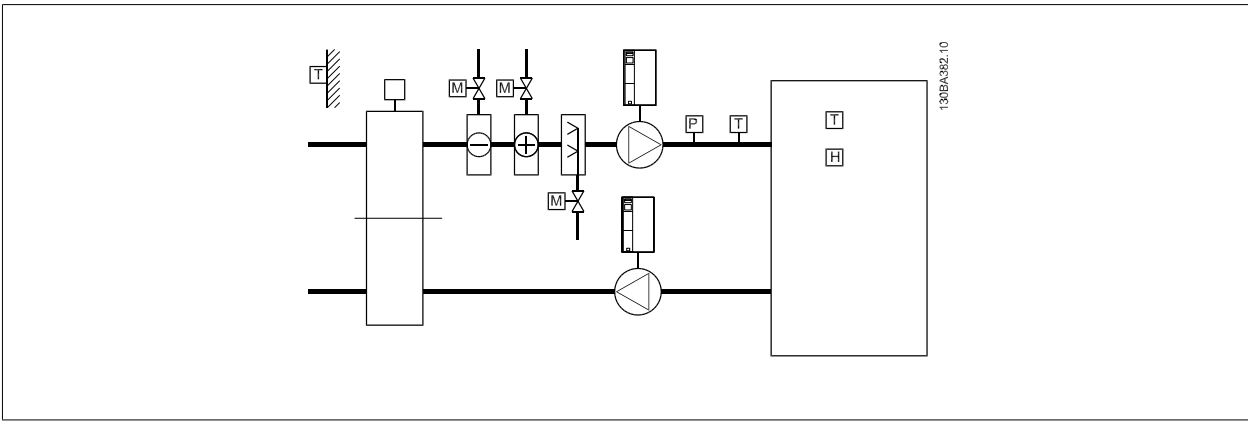

This shows a typical Air Handling Unit (AHU). As can be seen, the addition of the Analog I/O option offers the possibility to control all of the functions from the frequency converter, such as inlet-, return- and exhaust dampers or heating/cooling coils with temperature and pressure measurements being read by the frequency converter.

 **NB!**
The maximum current for the analog outputs 0-10V is 1mA.

 **NB!**
Where Live Zero Monitoring is used, it is important that any analog inputs not being used for the frequency controller, i.e. being used as part of the Building Management System decentral I/O, should have their Live Zero function disabled.

Terminal	Parameters	Terminal	Parameters	Terminal	Parameters
Analog inputs		Analog inputs		Relays	
X42/1	par. 26-00 <i>Terminal X42/1 Mode</i> , 26-1*	53	6-1*	Relay 1 Term 1, 2, 3	5-4*
X42/3	par. 26-01 <i>Terminal X42/3 Mode</i> , 26-2*	54	6-2*	Relay 2 Term 4, 5, 6	5-4*
X42/5	par. 26-02 <i>Terminal X42/5 Mode</i> , 26-3*				
Analog outputs		Analog output			
X42/7	26-4*	42	6-5*		
X42/9	26-5*				
X42/11	26-6*				

Table 3.2: Relevant parameters

It is also possible to read the analog inputs, write to the analog outputs and control the relays, using communication via the serial bus. In this instance, these are the relevant parameters.

Terminal	Parameters	Terminal	Parameters	Terminal	Parameters
Analog inputs (read)		Analog inputs (read)		Relays	
X42/1	par. 18-30 <i>Analog Input X42/1</i>	53	par. 16-62 <i>Analog Input 53</i>	Relay 1 Term 1, 2, 3	par. 16-71 <i>Relay Output [bin]</i>
X42/3	par. 18-31 <i>Analog Input X42/3</i>	54	par. 16-64 <i>Analog Input 54</i>	Relay 2 Term 4, 5, 6	par. 16-71 <i>Relay Output [bin]</i>
X42/5	par. 18-32 <i>Analog Input X42/5</i>				
Analog outputs (write)		Analog output (write)			
X42/7	par. 18-33 <i>Analog Out X42/7 [V]</i>	42	par. 6-53 <i>Terminal 42 Output Bus Control</i>	NOTE! The relay outputs must be enabled via Control Word Bit 11 (Relay 1) and Bit 12 (Relay 2)	
X42/9	par. 18-34 <i>Analog Out X42/9 [V]</i>				
X42/11	par. 18-35 <i>Analog Out X42/11 [V]</i>				

Table 3.3: Relevant parameters

Setting of on-board Real Time Clock.

The Analog I/O option incorporates a real time clock with battery back-up. This can be used as back up of the clock function included in the frequency converter as standard. See section Clock Settings, par. 0-7*.

The Analog I/O option can be used for the control of devices such as actuators or valves, using the Extended Closed loop facility, thus removing control from the Building Management System. See section Parameters: Ext. Closed Loop – FC 100 par. 21-**. There are three independent closed loop PID controllers.

26-00 Terminal X42/1 Mode

Option:
Function:

Terminal X42/1 can be programmed as an analog input accepting a voltage or input from either Pt1000 (1000 Ω at 0°C) or Ni 1000 (1000 Ω at 0°C) temperature sensors. Select the desired mode. *Pt 1000*, [2] and *Ni 1000* [4] if operating in Celsius - Pt 1000 [3] and Ni 1000 [5] if operating in Fahrenheit.

Notice: If the input is not in use, it must be set for Voltage!

If set for temperature and used as feed back, the unit must be set for either Celsius or Fahrenheit (par. 20-12 *Reference/Feedback Unit*, par. 21-10 *Ext. 1 Ref./Feedback Unit*, par. 21-30 *Ext. 2 Ref./Feedback Unit* or par. 21-50 *Ext. 3 Ref./Feedback Unit*).

[1] * Voltage

[2] Pt 1000 [°C]

[3] Pt 1000 [°F]

[4] Ni 1000 [°C]

[5] Ni 1000 [°F]

26-01 Terminal X42/3 Mode

Option:
Function:

Terminal X42/3 can be programmed as an analog input accepting a voltage or input from either Pt 1000 or Ni 1000 temperature sensors. Select the desired mode.

Pt 1000, [2] and Ni 1000, [4] if operating in Celsius - Pt 1000, [3] and Ni 1000, [5] if operating in Fahrenheit.

Notice: If the input is not in use, it must be set for Voltage!

If set for temperature and used as feed back, the unit must be set for either Celsius or Fahrenheit (par. 20-12 *Reference/Feedback Unit*, par. 21-10 *Ext. 1 Ref./Feedback Unit*, par. 21-30 *Ext. 2 Ref./Feedback Unit* or par. 21-50 *Ext. 3 Ref./Feedback Unit*).

[1] * Voltage

[2] Pt 1000 [°C]

[3] Pt 1000 [°F]

[4] Ni 1000 [°C]

[5] Ni 1000 [°F]

26-02 Terminal X42/5 Mode

Option:
Function:

Terminal X42/5 can be programmed as an analog input accepting a voltage or input from either Pt 1000 (1000 Ω at 0° C) or Ni 1000 (1000 Ω at 0° C) temperature sensors. Select the desired mode. Pt 1000, [2] and Ni 1000, [4] if operating in Celsius - Pt 1000, [3] and Ni 1000, [5] if operating in Fahrenheit.

Notice: If the input is not in use, it must be set for Voltage!

If set for temperature and used as feed back, the unit must be set for either Celsius or Fahrenheit (par. 20-12 *Reference/Feedback Unit*, par. 21-10 *Ext. 1 Ref./Feedback Unit*, par. 21-30 *Ext. 2 Ref./Feedback Unit* or par. 21-50 *Ext. 3 Ref./Feedback Unit*).

[1] * Voltage

[2] Pt 1000 [°C]

[3] Pt 1000 [°F]

[4] Ni 1000 [°C]

[5] Ni 1000 [°F]

26-10 Terminal X42/1 Low Voltage

Range:
Function:

0.07 V* [0.00 - par. 6-31 V]

Enter the low voltage value. This analog input scaling value should correspond to the low reference/feedback value set in par. 26-14 *Term. X42/1 Low Ref./Feedb. Value*.

26-11 Terminal X42/1 High Voltage**Range:**

10.00 V* [par. 6-30 - 10.00 V]

Function:Enter the high voltage value. This analog input scaling value should correspond to the high reference/feedback value set in par. 26-15 *Term. X42/1 High Ref./Feedb. Value.***26-14 Term. X42/1 Low Ref./Feedb. Value****Range:**

0.000 N/A* [-999999.999 - 999999.999 N/A]

Function:Enter the analog input scaling value that corresponds to the low voltage value set in par. 26-10 *Terminal X42/1 Low Voltage.***26-15 Term. X42/1 High Ref./Feedb. Value****Range:**

100.000 N/A* [-999999.999 - 999999.999 N/A]

Function:Enter the analog input scaling value that corresponds to the high voltage value set in par. 26-11 *Terminal X42/1 High Voltage.***26-16 Term. X42/1 Filter Time Constant****Range:**

0.001 s* [0.001 - 10.000 s]

Function:

Enter the time constant. This is a first-order digital low pass filter time constant for suppressing noise in terminal X42/1. A high time constant value improves dampening but also increases the time delay through the filter. This parameter cannot be adjusted while the motor is running.

26-17 Term. X42/1 Live Zero**Option:****Function:**

This parameter makes it possible to enable the Live Zero monitoring. E.g. where the analog input is a part of the frequency converter control, rather than being used as part of a decentral I/O system, such as a Building Management System.

[0] Disabled

[1] * Enabled

26-20 Terminal X42/3 Low Voltage**Range:**

0.07 V* [0.00 - par. 6-31 V]

Function:Enter the low voltage value. This analog input scaling value should correspond to the low reference/feedback value set in par. 26-24 *Term. X42/3 Low Ref./Feedb. Value.***26-21 Terminal X42/3 High Voltage****Range:**

10.00 V* [par. 6-30 - 10.00 V]

Function:Enter the high voltage value. This analog input scaling value should correspond to the high reference/feedback value set in par. 26-25 *Term. X42/3 High Ref./Feedb. Value.***26-24 Term. X42/3 Low Ref./Feedb. Value****Range:**

0.000 N/A* [-999999.999 - 999999.999 N/A]

Function:Enter the analog input scaling value that corresponds to the low voltage value set in par. 26-20 *Terminal X42/3 Low Voltage.***26-25 Term. X42/3 High Ref./Feedb. Value****Range:**

100.000 N/A* [-999999.999 - 999999.999 N/A]

Function:Enter the analog input scaling value that corresponds to the high voltage value set in par. 26-21 *Terminal X42/3 High Voltage.*

26-26 Term. X42/3 Filter Time Constant

Range:

0.001 s* [0.001 - 10.000 s]

Function:

Enter the time constant. This is a first-order digital low pass filter time constant for suppressing noise in terminal X42/3. A high time constant value improves dampening but also increases the time delay through the filter. This parameter cannot be adjusted while the motor is running.

26-27 Term. X42/3 Live Zero

Option:

[0] Disabled

[1] * Enabled

Function:

This parameter makes it possible to enable the Live Zero monitoring. E.g. where the analog input is a part of the frequency converter control, rather than being used as part of a decentral I/O system, such as a Building Management System.

26-30 Terminal X42/5 Low Voltage

Range:

0.07 V* [0.00 - par. 6-31 V]

Function:

Enter the low voltage value. This analog input scaling value should correspond to the low reference/feedback value set in par. 26-34 *Term. X42/5 Low Ref./Feedb. Value*.

26-31 Terminal X42/5 High Voltage

Range:

10.00 V* [par. 6-30 - 10.00 V]

Function:

Enter the high voltage value. This analog input scaling value should correspond to the high reference/feedback value set in par. 26-35 *Term. X42/5 High Ref./Feedb. Value*.

26-34 Term. X42/5 Low Ref./Feedb. Value

Range:

0.000 N/A* [-999999.999 - 999999.999 N/A]

Function:

Enter the analog input scaling value that corresponds to the low voltage value set in par. 26-30 *Terminal X42/5 Low Voltage*.

26-35 Term. X42/5 High Ref./Feedb. Value

Range:

100.000 N/A* [-999999.999 - 999999.999 N/A]

Function:

Enter the analog input scaling value that corresponds to the high voltage value set in par. 26-31 *Terminal X42/3 High Voltage*.

26-36 Term. X42/5 Filter Time Constant

Range:

0.001 s* [0.001 - 10.000 s]

Function:

Enter the time constant. This is a first-order digital low pass filter time constant for suppressing noise in terminal X42/5. A high time constant value improves dampening but also increases the time delay through the filter. This parameter cannot be adjusted while the motor is running.

26-37 Term. X42/5 Live Zero

Option:

[0] Disabled

[1] * Enabled

Function:

This parameter makes it possible to enable the Live Zero monitoring. E.g. where the analog input is a part of the frequency converter control, rather than being used as part of a decentral I/O system, such as a Building Management System.

26-40 Terminal X42/7 Output

Option:

[0] * No operation

Function:

Set the function of terminal X42/7 as an analog voltage output.

[100]	Output freq. 0-100
[101]	Reference Min-Max
[102]	Feedback +-200%
[103]	Motor cur. 0-Imax
[104]	Torque 0-Tlim
[105]	Torque 0-Tnom
[106]	Power 0-Pnom
[107]	Speed 0-HighLim
[113]	Ext. Closed Loop 1
[114]	Ext. Closed Loop 2
[115]	Ext. Closed Loop 3
[139]	Bus ctrl.
[141]	Bus ctrl t.o.

26-41 Terminal X42/7 Min. Scale

Range:

0.00 %* [0.00 - 200.00 %]

Function:

Scale the minimum output of the selected analog signal at terminal X42/7, as a percentage of the maximum signal level. E.g. if a 0 V (or 0 Hz) is desired at 25% of the maximum output value. Then programme 25%. Scaling values up to 100% can never be higher than the corresponding setting in par. 26-42 *Terminal X42/7 Max. Scale*.

See principle graph for par. 6-51 *Terminal 42 Output Min Scale*.

26-42 Terminal X42/7 Max. Scale

Range:

100.00 %* [0.00 - 200.00 %]

Function:

Scale the maximum output of the selected analog signal at terminal X42/7. Set the value to the maximum value of the voltage signal output. Scale the output to give a voltage lower than 10V at full scale; or 10V at an output below 100% of the maximum signal value. If 10V is the desired output current at a value between 0-100% of the full-scale output, programme the percentage value in the parameter, i.e. 50% = 10V. If a voltage between 0 and 10V is desired at maximum output, calculate the percentage as follows:

$$\left(\frac{10V}{\text{desired maximum voltage}} \right) \times 100\%$$

i.e.

$$5V : \frac{10V}{5V} \times 100\% = 200\%$$

See principle graph for par. 6-52 *Terminal 42 Output Max Scale*.

26-43 Terminal X42/7 Bus Control

Range:

0.00 %* [0.00 - 100.00 %]

Function:

Holds the level of terminal X42/7 if controlled by bus.

26-44 Terminal X42/7 Timeout Preset

Range:

0.00 %* [0.00 - 100.00 %]

Function:

Holds the preset level of terminal X42/7.

In case of a bus timeout and a timeout function is selected in par. 26-50 *Terminal X42/9 Output* the output will preset to this level.

26-50 Terminal X42/9 Output

Option:

[0] * No operation

[100] Output freq. 0-100

Function:

Set the function of terminal X42/9.

[101]	Reference Min-Max
[102]	Feedback +-200%
[103]	Motor cur. 0-Imax
[104]	Torque 0-Tlim
[105]	Torque 0-Tnom
[106]	Power 0-Pnom
[107]	Speed 0-HighLim
[113]	Ext. Closed Loop 1
[114]	Ext. Closed Loop 2
[115]	Ext. Closed Loop 3
[139]	Bus ctrl.
[141]	Bus ctrl t.o.

26-51 Terminal X42/9 Min. Scale

Range:	Function:
0.00 %* [0.00 - 200.00 %]	Scale the minimum output of the selected analog signal at terminal X42/9, as a percentage of the maximum signal level. E.g. if a 0 V is desired at 25% of the maximum output value. Then programme 25%. Scaling values up to 100% can never be higher than the corresponding setting in par. 26-52 <i>Terminal X42/9 Max. Scale</i> .

See principle graph for par. 6-51 *Terminal 42 Output Min Scale*.

26-52 Terminal X42/9 Max. Scale

Range:	Function:
100.00 %* [0.00 - 200.00 %]	Scale the maximum output of the selected analog signal at terminal X42/9. Set the value to the maximum value of the voltage signal output. Scale the output to give a voltage lower than 10V at full scale; or 10V at an output below 100% of the maximum signal value. If 10V is the desired output current at a value between 0-100% of the full-scale output, programme the percentage value in the parameter, i.e. 50% = 10V. If a voltage between 0 and 10V is desired at maximum output, calculate the percentage as follows: $\left(\frac{10V}{\text{desired maximum voltage}} \right) \times 100\%$ i.e. $5V : \frac{10V}{5V} \times 100\% = 200\%$

See principle graph for par. 6-52 *Terminal 42 Output Max Scale*.

26-53 Terminal X42/9 Bus Control

Range:	Function:
0.00 %* [0.00 - 100.00 %]	Holds the level of terminal X42/9 if controlled by bus.

26-54 Terminal X42/9 Timeout Preset

Range:	Function:
0.00 %* [0.00 - 100.00 %]	Holds the preset level of terminal X42/9. In case of a bus timeout and a timeout function is selected in par. 26-60 <i>Terminal X42/11 Output</i> the output will preset to this level.

26-60 Terminal X42/11 Output

Option:	Function:
	Set the function of terminal X42/11.

[0] *	No operation
[100]	Output freq. 0-100
[101]	Reference Min-Max

[102]	Feedback +-200%
[103]	Motor cur. 0-Imax
[104]	Torque 0-Tlim
[105]	Torque 0-Tnom
[106]	Power 0-Pnom
[107]	Speed 0-HighLim
[113]	Ext. Closed Loop 1
[114]	Ext. Closed Loop 2
[115]	Ext. Closed Loop 3
[139]	Bus ctrl.
[141]	Bus ctrl t.o.

26-61 Terminal X42/11 Min. Scale

Range:	Function:
0.00 %* [0.00 - 200.00 %]	Scale the minimum output of the selected analog signal at terminal X42/11, as a percentage of the maximum signal level. E.g. if a 0 V is desired at 25% of the maximum output value. Then programme 25%. Scaling values up to 100% can never be higher than the corresponding setting in par. 26-62 <i>Terminal X42/11 Max. Scale</i> .

See principle graph for par. 6-51 *Terminal 42 Output Min Scale*.

26-62 Terminal X42/11 Max. Scale

Range:	Function:
100.00 %* [0.00 - 200.00 %]	Scale the maximum output of the selected analog signal at terminal X42/9. Set the value to the maximum value of the voltage signal output. Scale the output to give a voltage lower than 10V at full scale; or 10V at an output below 100% of the maximum signal value. If 10V is the desired output current at a value between 0-100% of the full-scale output, programme the percentage value in the parameter, i.e. 50% = 10V. If a voltage between 0 and 10V is desired at maximum output, calculate the percentage as follows: $\left(\frac{10V}{\text{desired maximum voltage}} \right) \times 100\%$ i.e. $5V : \frac{10V}{5V} \times 100\% = 200\%$

See principle graph for par. 6-52 *Terminal 42 Output Max Scale*.

26-63 Terminal X42/11 Bus Control

Range:	Function:
0.00 %* [0.00 - 100.00 %]	Holds the level of terminal X42/11 if controlled by bus.

26-64 Terminal X42/11 Timeout Preset

Range:	Function:
0.00 %* [0.00 - 100.00 %]	Holds the preset level of terminal X42/11. In case a bus timeout and a timeout function are selected, the output will preset to this level.

4

4 Troubleshooting

4.1.1 Alarms and warnings

A warning or an alarm is signalled by the relevant LED on the front of the frequency converter and indicated by a code on the display.

A warning remains active until its cause is no longer present. Under certain circumstances operation of the motor may still be continued. Warning messages may be critical, but are not necessarily so.

In the event of an alarm, the frequency converter will have tripped. Alarms must be reset to restart operation once their cause has been rectified. This may be done in four ways:

1. By using the [RESET] control button on the LCP control panel.
2. Via a digital input with the "Reset" function.
3. Via serial communication/optional fieldbus.
4. By resetting automatically using the [Auto Reset] function, which is a default setting for frequency converter. see par. 14-20 *Reset Mode* in *VLT HVAC Drive Programming Guide, MG.11.Cx.yy*

**NB!**

After a manual reset using the [RESET] button on the LCP, the [AUTO ON] button must be pressed to restart the motor.

If an alarm cannot be reset, the reason may be that its cause has not been rectified, or the alarm is trip-locked (see also table on following page).

Alarms that are trip-locked offer additional protection, means that the mains supply must be switched off before the alarm can be reset. After being switched back on, the frequency converter is no longer blocked and may be reset as described above once the cause has been rectified.

Alarms that are not trip-locked can also be reset using the automatic reset function in par. 14-20 *Reset Mode* (Warning: automatic wake-up is possible!)

If a warning and alarm is marked against a code in the table on the following page, this means that either a warning occurs before an alarm, or it can be specified whether it is a warning or an alarm that is to be displayed for a given fault.

This is possible, for instance, in par. 1-90 *Motor Thermal Protection*. After an alarm or trip, the motor carries on coasting, and the alarm and warning flash on the frequency converter. Once the problem has been rectified, only the alarm continues flashing.

No.	Description	Warning	Alarm/Trip	Alarm/Trip Lock	Parameter Reference
1	10 Volts low	X			
2	Live zero error	(X)	(X)		par. 6-01 <i>Live Zero Time-out Function</i>
3	No motor	(X)			par. 1-80 <i>Function at Stop</i>
4	Mains phase loss	(X)	(X)	(X)	par. 14-12 <i>Function at Mains Imbalance</i>
5	DC link voltage high	X			
6	DC link voltage low	X			
7	DC over voltage	X	X		
8	DC under voltage	X	X		
9	Inverter overloaded	X	X		
10	Motor ETR over temperature	(X)	(X)		par. 1-90 <i>Motor Thermal Protection</i>
11	Motor thermistor over temperature	(X)	(X)		par. 1-90 <i>Motor Thermal Protection</i>
12	Torque limit	X	X		
13	Over Current	X	X	X	
14	Earth fault	X	X	X	
15	Incomp. HW		X	X	
16	Short Circuit		X	X	
17	Control word timeout	(X)	(X)		par. 8-04 <i>Control Time-out Function</i>
23	Internal fans				
24	External fans				
25	Brake resistor short-circuited	X			
26	Brake resistor power limit	(X)	(X)		par. 2-13 <i>Brake Power Monitoring</i>
27	Brake chopper short-circuited	X	X		
28	Brake check	(X)	(X)		par. 2-15 <i>Brake Check</i>
29	Power board over temp	X	X	X	
30	Motor phase U missing	(X)	(X)	(X)	par. 4-58 <i>Missing Motor Phase Function</i>
31	Motor phase V missing	(X)	(X)	(X)	par. 4-58 <i>Missing Motor Phase Function</i>
32	Motor phase W missing	(X)	(X)	(X)	par. 4-58 <i>Missing Motor Phase Function</i>
33	Inrush fault		X	X	
34	Fieldbus communication fault	X	X		
36	Mains failure				
38	Internal fault		X	X	
40	Overload T27				
41	Overload T29				
42	Overload X30/6-7				
47	24 V supply low	X	X	X	
48	1.8 V supply low		X	X	
49	Speed limit				
50	AMA calibration failed		X		
51	AMA check U_{nom} and I_{nom}		X		
52	AMA low I_{nom}		X		
53	AMA motor too big		X		
54	AMA motor too small		X		
55	AMA parameter out of range		X		
56	AMA interrupted by user		X		
57	AMA timeout		X		
58	AMA internal fault	X	X		
59	Current limit	X			
60	External interlock				
62	Output Frequency at Maximum Limit	X			
64	Voltage Limit	X			
65	Control Board Over-temperature	X	X	X	
66	Heat sink Temperature Low	X			
67	Option Configuration has Changed		X		
68	Safe Stop Activated		X		
70	Illegal FC configuration				
80	Drive Initialised to Default Value		X		
92	No-Flow	X	X		Par. 22-2*
93	Dry Pump	X	X		Par. 22-2*
94	End of Curve	X	X		Par. 22-5*
95	Broken Belt	X	X		Par. 22-6*
96	Start Delayed	X			Par. 22-7*
97	Stop Delayed	X			Par. 22-7*
98	Clock Fault	X			Par. 0-7*

Table 4.1: Alarm/Warning code list

No.	Description	Warning	Alarm/Trip	Alarm/Trip Lock	Parameter Reference
200	Fire Mode	X			Par. 24-0*
201	Fire Mode was Active	X			Par. 0-7*
202	Fire Mode Limits Exceeded	X			Par. 0-7*
250	New spare part				
251	New type code				

Table 4.1: Alarm/Warning code list, continued..

(X) Dependent on parameter

LED indication	
Warning	yellow
Alarm	flashing red
Trip locked	yellow and red

Alarm Word and Extended Status Word					
Bit	Hex	Dec	Alarm Word	Warning Word	Extended Status Word
0	00000001	1	Brake Check	Brake Check	Ramping
1	00000002	2	Pwr. Card Temp	Pwr. Card Temp	AMA Running
2	00000004	4	Earth Fault	Earth Fault	Start CW/CCW
3	00000008	8	Ctrl.Card Temp	Ctrl.Card Temp	Slow Down
4	00000010	16	Ctrl. Word TO	Ctrl. Word TO	Catch Up
5	00000020	32	Over Current	Over Current	Feedback High
6	00000040	64	Torque Limit	Torque Limit	Feedback Low
7	00000080	128	Motor Th Over	Motor Th Over	Output Current High
8	00000100	256	Motor ETR Over	Motor ETR Over	Output Current Low
9	00000200	512	Inverter Overld.	Inverter Overld.	Output Freq High
10	00000400	1024	DC under Volt	DC under Volt	Output Freq Low
11	00000800	2048	DC over Volt	DC over Volt	Brake Check OK
12	00001000	4096	Short Circuit	DC Voltage Low	Braking Max
13	00002000	8192	Inrush Fault	DC Voltage High	Braking
14	00004000	16384	Mains ph. Loss	Mains ph. Loss	Out of Speed Range
15	00008000	32768	AMA Not OK	No Motor	OVC Active
16	00010000	65536	Live Zero Error	Live Zero Error	
17	00020000	131072	Internal Fault	10V Low	
18	00040000	262144	Brake Overload	Brake Overload	
19	00080000	524288	U phase Loss	Brake Resistor	
20	00100000	1048576	V phase Loss	Brake IGBT	
21	00200000	2097152	W phase Loss	Speed Limit	
22	00400000	4194304	Fieldbus Fault	Fieldbus Fault	
23	00800000	8388608	24 V Supply Low	24V Supply Low	
24	01000000	16777216	Mains Failure	Mains Failure	
25	02000000	33554432	1.8V Supply Low	Current Limit	
26	04000000	67108864	Brake Resistor	Low Temp	
27	08000000	134217728	Brake IGBT	Voltage Limit	
28	10000000	268435456	Option Change	Unused	
29	20000000	536870912	Drive Initialised	Unused	
30	40000000	1073741824	Safe Stop	Unused	

Table 4.1: Description of Alarm Word, Warning Word and Extended Status Word

The alarm words, warning words and extended status words can be read out via serial bus or optional field-bus for diagnosis. See also par. 16-90 *Alarm Word*, par. 16-92 *Warning Word* and par. 16-94 *Ext. Status Word*.

4.1.2 Alarm words

Alarm word, par. 16-90 *Alarm Word*

Bit (Hex)	Alarm Word (par. 16-90 <i>Alarm Word</i>)
00000001	Brake check
00000002	Power card over temperature
00000004	Earth fault
00000008	Ctrl. card over temperature
00000010	Control word timeout
00000020	Over current
00000040	Torque limit
00000080	Motor thermistor over temp.
00000100	Motor ETR over temperature
00000200	Inverter overloaded
00000400	DC link under voltage
00000800	DC link over voltage
00001000	Short circuit
00002000	Inrush fault
00004000	Mains phase loss
00008000	AMA not OK
00010000	Live zero error
00020000	Internal fault
00040000	Brake overload
00080000	Motor phase U is missing
00100000	Motor phase V is missing
00200000	Motor phase W is missing
00400000	Fieldbus fault
00800000	24V supply fault
01000000	Mains failure
02000000	1.8V supply fault
04000000	Brake resistor short circuit
08000000	Brake chopper fault
10000000	Option change
20000000	Drive initialized
40000000	Safe Stop
80000000	Not used

Alarm word 2, par. 16-91 *Alarm Word 2*

Bit (Hex)	Alarm Word 2 (par. 16-91 <i>Alarm Word 2</i>)
00000001	Service Trip, read / Write
00000002	Reserved
00000004	Service Trip, Typecode / Sparepart
00000008	Reserved
00000010	Reserved
00000020	No Flow
00000040	Dry Pump
00000080	End of Curve
00000100	Broken Belt
00000200	Not used
00000400	Not used
00000800	Reserved
00001000	Reserved
00002000	Reserved
00004000	Reserved
00008000	Reserved
00010000	Reserved
00020000	Not used
00040000	Fans error
00080000	ECB error
00100000	Reserved
00200000	Reserved
00400000	Reserved
00800000	Reserved
01000000	Reserved
02000000	Reserved
04000000	Reserved
08000000	Reserved
10000000	Reserved
20000000	Reserved
40000000	Reserved
80000000	Reserved

4.1.3 Warning words

Warning word , par. 16-92 *Warning Word*

Bit (Hex)	Warning Word (par. 16-92 <i>Warning Word</i>)
00000001	Brake check
00000002	Power card over temperature
00000004	Earth fault
00000008	Ctrl. card over temperature
00000010	Control word timeout
00000020	Over current
00000040	Torque limit
00000080	Motor thermistor over temp.
00000100	Motor ETR over temperature
00000200	Inverter overloaded
00000400	DC link under voltage
00000800	DC link over voltage
00001000	DC link voltage low
00002000	DC link voltage high
00004000	Mains phase loss
00008000	No motor
00010000	Live zero error
00020000	10V low
00040000	Brake resistor power limit
00080000	Brake resistor short circuit
00100000	Brake chopper fault
00200000	Speed limit
00400000	Fieldbus comm. fault
00800000	24V supply fault
01000000	Mains failure
02000000	Current limit
04000000	Low temperature
08000000	Voltage limit
10000000	Encoder loss
20000000	Output frequency limit
40000000	Not used
80000000	Not used

Warning word 2, par. 16-93 *Warning Word 2*

Bit (Hex)	Warning Word 2 (par. 16-93 <i>Warning Word 2</i>)
00000001	Start Delayed
00000002	Stop Delayed
00000004	Clock Failure
00000008	Reserved
00000010	Reserved
00000020	No Flow
00000040	Dry Pump
00000080	End of Curve
00000100	Broken Belt
00000200	Not used
00000400	Reserved
00000800	Reserved
00001000	Reserved
00002000	Reserved
00004000	Reserved
00008000	Reserved
00010000	Reserved
00020000	Not used
00040000	Fans warning
00080000	ECB warning
00100000	Reserved
00200000	Reserved
00400000	Reserved
00800000	Reserved
01000000	Reserved
02000000	Reserved
04000000	Reserved
08000000	Reserved
10000000	Reserved
20000000	Reserved
40000000	Reserved
80000000	Reserved

4.1.4 Extended status words

Extended status word, par. 16-94 *Ext. Status Word*

Bit (Hex)	Extended Status Word (par. 16-94 <i>Ext. Status Word</i>)
00000001	Ramping
00000002	AMA tuning
00000004	Start CW/CCW
00000008	Not used
00000010	Not used
00000020	Feedback high
00000040	Feedback low
00000080	Output current high
00000100	Output current low
00000200	Output frequency high
00000400	Output frequency low
00000800	Brake check OK
00001000	Braking max
00002000	Braking
00004000	Out of speed range
00008000	OVC active
00010000	AC brake
00020000	Password Timelock
00040000	Password Protection
00080000	Reference high
00100000	Reference low
00200000	Local Ref./Remote Ref.
00400000	Reserved
00800000	Reserved
01000000	Reserved
02000000	Reserved
04000000	Reserved
08000000	Reserved
10000000	Reserved
20000000	Reserved
40000000	Reserved
80000000	Reserved

Extended status word 2, par. 16-95 *Ext. Status Word 2*

Bit (Hex)	Extended Status Word 2 (par. 16-95 <i>Ext. Status Word 2</i>)
00000001	Off
00000002	Hand / Auto
00000004	Not used
00000008	Not used
00000010	Not used
00000020	Relay 123 active
00000040	Start Prevented
00000080	Control ready
00000100	Drive ready
00000200	Quick Stop
00000400	DC Brake
00000800	Stop
00001000	Standby
00002000	Freeze Output Request
00004000	Freeze Output
00008000	Jog Request
00010000	Jog
00020000	Start Request
00040000	Start
00080000	Start Applied
00100000	Start Delay
00200000	Sleep
00400000	Sleep Boost
00800000	Running
01000000	Bypass
02000000	Fire Mode
04000000	Reserved
08000000	Reserved
10000000	Reserved
20000000	Reserved
40000000	Reserved
80000000	Reserved

4.1.5 Fault messages

WARNING 1, 10 Volts low:

The 10 V voltage from terminal 50 on the control card is below 10 V. Remove some of the load from terminal 50, as the 10 V supply is overloaded. Max. 15 mA or minimum 590 Ω.

WARNING/ALARM 2, Live zero error:

The signal on terminal 53 or 54 is less than 50% of the value set in par. 6-10 *Terminal 53 Low Voltage*, par. 6-12 *Terminal 53 Low Current*, par. 6-20 *Terminal 54 Low Voltage*, or par. 6-22 *Terminal 54 Low Current* respectively.

WARNING/ALARM 3, No motor:

No motor has been connected to the output of the frequency converter.

WARNING/ALARM 4, Mains phase loss:

A phase is missing on the supply side, or the mains voltage imbalance is too high.

This message also appears in case of a fault in the input rectifier on the frequency converter.

Check the supply voltage and supply currents to the frequency converter.

WARNING 5, DC link voltage high:

The intermediate circuit voltage (DC) is higher than the over-voltage limit of the control system. The frequency converter is still active.

WARNING 6, DC link voltage low:

The intermediate circuit voltage (DC) is below the undervoltage limit of the control system. The frequency converter is still active.

WARNING/ALARM 7, DC over voltage:

If the intermediate circuit voltage exceeds the limit, the frequency converter trips after a time.

Possible corrections:

Select Over Voltage Control function in par. 2-17 *Over-voltage Control*

Connect a brake resistor

Extend the ramp time

Activate functions in par. 2-10 *Brake Function*

Increase par. 14-26 *Trip Delay at Inverter Fault*

Selecting OVC function will extend the ramp times.

Alarm/warning limits:			
Voltage Range	3 x 200-240 VAC [VDC]	3 x 380-500 VAC [VDC]	3 x 550-600 VAC [VDC]
Under voltage	185	373	532
Voltage warning low	205	410	585
Voltage warning high (w/o brake - w/ brake)	390/405	810/840	943/965
Over voltage	410	855	975

The voltages stated are the intermediate circuit voltage of the frequency converter with a tolerance of ± 5 %. The corresponding mains voltage is the intermediate circuit voltage (DC-link) divided by 1.35

WARNING/ALARM 8, DC under voltage:

If the intermediate circuit voltage (DC) drops below the "voltage warning low" limit (see table above), the frequency converter checks if 24 V backup supply is connected.

If no 24 V backup supply is connected, the frequency converter trips after a given time depending on the unit.

To check whether the supply voltage matches the frequency converter, see 3.1 *General Specifications*.

WARNING/ALARM 9, Inverter overloaded:

The frequency converter is about to cut out because of an overload (too high current for too long). The counter for electronic, thermal inverter protection gives a warning at 98% and trips at 100%, while giving an alarm. You cannot reset the frequency converter until the counter is below 90%.

The fault is that the frequency converter is overloaded by more than nominal current for too long.

WARNING/ALARM 10, Motor ETR over temperature:

According to the electronic thermal protection (ETR), the motor is too hot. You can choose if you want the frequency converter to give a warning or an alarm when the counter reaches 100% in par. 1-90 *Motor Thermal Protection*. The fault is that the motor is overloaded by more than nominal current for too long. Check that the motor par. 1-24 *Motor Current* is set correctly.

WARNING/ALARM 11, Motor thermistor over temp:

The thermistor or the thermistor connection is disconnected. You can choose if you want the frequency converter to give a warning or an alarm in par. 1-90 *Motor Thermal Protection*. Check that the thermistor is connected correctly between terminal 53 or 54 (analog voltage input) and terminal 50 (+ 10 Volts supply), or between terminal 18 or 19 (digital input PNP only) and terminal 50. If a KTY sensor is used, check for correct connection between terminal 54 and 55.

WARNING/ALARM 12, Torque limit:

The torque is higher than the value in par. 4-16 *Torque Limit Motor Mode* (in motor operation) or the torque is higher than the value in par. 4-17 *Torque Limit Generator Mode* (in regenerative operation).

WARNING/ALARM 13, Over Current:

The inverter peak current limit (approx. 200% of the rated current) is exceeded. The warning will last approx. 8-12 sec., then the frequency converter trips and issues an alarm. Turn off the frequency converter and check if the motor shaft can be turned and if the motor size matches the frequency converter.

ALARM 14, Earth fault:

There is a discharge from the output phases to earth, either in the cable between the frequency converter and the motor or in the motor itself. Turn off the frequency converter and remove the earth fault.

ALARM 15, In-complete hardware:

A fitted option is not handled by the present control board (hardware or software).

ALARM 16, Short-circuit:

There is short-circuiting in the motor or on the motor terminals. Turn off the frequency converter and remove the short-circuit.

WARNING/ALARM 17, Control word timeout:

There is no communication to the frequency converter.

The warning will only be active when par. 8-04 *Control Timeout Function* is NOT set to OFF.

If par. 8-04 *Control Timeout Function* is set to Stop and Trip, a warning appears and the frequency converter ramps down to zero speed, while giving an alarm.

par. 8-03 *Control Timeout Time* could possibly be increased.

WARNING 22, Hoist Mech. Brake:

Report value will show what kind it is.

0 = The torque ref. was not reached before timeout

1 = There was no brake feedback before timeout

WARNING 23, Internal fans:

External fans have failed due to defect hardware or fans not mounted.

WARNING 24, External fan fault:

The fan warning function is an extra protection function that checks if the fan is running / mounted. The fan warning can be disabled in par. 14-53 *Fan Monitor*, [0] Disabled.

WARNING 25, Brake resistor short-circuited:

The brake resistor is monitored during operation. If it short-circuits, the brake function is disconnected and the warning appears. The frequency converter still works, but without the brake function. Turn off the frequency converter and replace the brake resistor (see par. 2-15 *Brake Check*).

ALARM/WARNING 26, Brake resistor power limit:

The power transmitted to the brake resistor is calculated as a percentage, as a mean value over the last 120 s, on the basis of the resistance value of the brake resistor (par. 2-11 *Brake Resistor (ohm)*) and the intermediate circuit voltage. The warning is active when the dissipated braking power is higher than 90%. If *Trip*[2] has been selected in par. 2-13 *Brake Power Monitoring*, the frequency converter cuts out and issues this alarm, when the dissipated braking power is higher than 100%.

WARNING/ALARM 27, Brake chopper fault:

The brake transistor is monitored during operation and if it short-circuits, the brake function disconnects and the warning comes up. The frequency converter is still able to run, but since the brake transistor has short-circuited, substantial power is transmitted to the brake resistor, even if it is inactive.

Turn off the frequency converter and remove the brake resistor.



Warning: There is a risk of substantial power being transmitted to the brake resistor if the brake transistor is short-circuited.

ALARM/WARNING 28, Brake check failed:

Brake resistor fault: the brake resistor is not connected/working.

WARNING/ALARM 29, Drive over temperature:

If the enclosure is IP00, IP20/Nema1 or IP21/TYP 1, the cut-out temperature of the heat-sink is 95 °C ±5 °C. The temperature fault cannot be reset, until the temperature of the heatsink is below 70 °C.

The fault could be:

- Ambient temperature too high
- Too long motor cable

ALARM 30, Motor phase U missing:

Motor phase U between the frequency converter and the motor is missing.

Turn off the frequency converter and check motor phase U.

ALARM 31, Motor phase V missing:

Motor phase V between the frequency converter and the motor is missing.

Turn off the frequency converter and check motor phase V.

ALARM 32, Motor phase W missing:

Motor phase W between the frequency converter and the motor is missing.

Turn off the frequency converter and check motor phase W.

ALARM 33, Inrush fault:

Too many powerups have occurred within a short time period. See the chapter *General Specifications* for the allowed number of power-ups within one minute.

WARNING/ALARM 34, Fieldbus communication fault:

The fieldbus on the communication option card is not working.

WARNING/ALARM 36, Mains failure:

This warning/alarm is only active if the supply voltage to the frequency converter is lost and parameter 14-10 is NOT set to OFF. Possible correction: check the fuses to the frequency converter

WARNING/ALARM 37, Phase Imbalance:

There is a current imbalance between the power units.

ALARM 38, Internal fault:

Contact your local Danfoss supplier.

ALARM 39, Heatsink Sensor:

No feedback from the heatsink sensor.

WARNING 40, Overload of Digital Output Terminal 27

Check the load connected to terminal 27 or remove short-circuit connection. Check parameters 5-00 and 5-01.

WARNING 41, Overload of Digital Output Terminal 29:

Check the load connected to terminal 29 or remove short-circuit connection. Check parameters 5-00 and 5-02.

WARNING 42, Overload of Digital Output On X30/6 :

Check the load connected to X30/6 or remove short-circuit connection. Check parameter 5-32.

WARNING 42, Overload of Digital Output On X30/7 :

Check the load connected to X30/7 or remove short-circuit connection. Check parameter 5-33.

ALARM 46, Pwr. card supply:

The supply on the power card is out of range.

WARNING 47, 24 V supply low:

The external 24 V DC backup power supply may be overloaded, otherwise contact your Danfoss supplier.

ALARM 48, 1.8 V supply low:

Contact your Danfoss supplier.

WARNING 49, Speed limit:

The speed has been limited by range in par. 4-11 *Motor Speed Low Limit [RPM]* and par. 4-13 *Motor Speed High Limit [RPM]*.

ALARM 50, AMA calibration failed:

Contact your Danfoss supplier.

ALARM 51, AMA check Unom and Inom:

The setting of motor voltage, motor current, and motor power is presumably wrong. Check the settings.

ALARM 52, AMA low Inom:

The motor current is too low. Check the settings.

ALARM 53, AMA motor too big:

The motor is too big for the AMA to be carried out.

ALARM 54, AMA motor too small:

The motor is too small for the AMA to be carried out.

ALARM 55, AMA par. out of range:

The par. values found from the motor are outside acceptable range.

ALARM 56, AMA interrupted by user:

The AMA has been interrupted by the user.

ALARM 57, AMA timeout:

Try to start the AMA again a number of times, until the AMA is carried out. Please note that repeated runs may heat the motor to a level where the resistance R_s and R_r are increased. In most cases, however, this is not critical.

WARNING/ALARM 58, AMA internal fault:

Contact your Danfoss supplier.

WARNING 59, Current limit:

The current is higher than the value in par. 4-18 *Current Limit*.

WARNING 60, External Interlock:

External Interlock has been activated. To resume normal operation, apply 24 VDC to the terminal programmed for External Interlock and reset the frequency converter (via Bus, Digital I/O or by pressing [Reset]).

WARNING/ALARM 61, Tracking Error:

Tracking error. Contact your supplier.

WARNING 62, Output Frequency at Maximum Limit:

The output frequency is limited by the value set in par. 4-19 *Max Output Frequency*

WARNING 64, Voltage Limit:

The load and speed combination demands a motor voltage higher than the actual DC link voltage.

WARNING/ALARM/TRIP 65, Control Card Over Temperature:

Control card over temperature: The cut-out temperature of the control card is 80° C.

WARNING 66, Heatsink Temperature Low:

The heat sink temperature is measured as 0° C. This could indicate that the temperature sensor is defective and thus the fan speed is increased to the maximum in case the power part or control card is very hot. If the temperature is below 15° C the warning will be present.

ALARM 67, Option Configuration has Changed:

One or more options has either been added or removed since the last power-down.

ALARM 68, Safe Stop:

Safe Stop has been activated. To resume normal operation, apply 24 VDC to terminal 37 then send a Reset signal (via Bus, Digital I/O or by pressing [Reset]).

ALARM 69, Pwr. Card Temp:

Power card over temperature.

ALARM 70, Illegal Frequency Converter Configuration:

Actual combination of control board and power board is illegal.

ALARM 90, Feedback Mon.:**ALARM 91, Analogue Input 54 Wrong Settings:**

Switch S202 has to be set in position OFF (voltage input), when a KTY sensor is connected to the analogue input terminal 54.

ALARM 92, NoFlow:

A no load situation has been detected for the system. See parameter group 22-2*.

ALARM 93, Dry Pump:

A no flow situation and high speed indicates that the pump has run dry. See parameter group 22-2*

ALARM 94, End of Curve:

Feed back stays lower than the set point, which may be indicates a leakage in the pipe system. See parameter group 22-5*

ALARM 95, Broken Belt:

Torque is below the torque level set for no load indicating a broken belt. See parameter group 22-6*

ALARM 96, Start Delayed:

Start of the motor has been delayed due to short cycle protection is active. See parameter group 22-7*.

ALARM 250, New Spare Part:

The power or Switch Mode Power Supply has been exchanged. The frequency converter type code must be restored in the EEPROM. Select the correct type code in Par 14-23 according to the label on unit. Remember to select 'Save to EEPROM' to complete.

ALARM 251, New Type Code:

The frequency converter has got a new type code.

5

5 Parameter Lists

5.1 Parameter Options

5.1.1 Default settings

Changes during operation:

"TRUE" means that the parameter can be changed while the frequency converter is in operation and "FALSE" means that the frequency converter must be stopped before a change can be made.

4-Set-up:

'All set-up': the parameter can be set individually in each of the four set-ups, i. e. one single parameter can have four different data values.

'1 set-up': data value will be the same in all set-ups.

SR:

Size related

N/A:

No default value available.

Conversion index:

This number refers to a conversion figure used when writing or reading by means of a frequency converter.

Conv. index	100	67	6	5	4	3	2	1	0	-1	-2	-3	-4	-5	-6
Conv. factor	1	1/60	1000000	100000	10000	1000	100	10	1	0.1	0.01	0.001	0.0001	0.00001	0.000001

Data type	Description	Type
2	Integer 8	Int8
3	Integer 16	Int16
4	Integer 32	Int32
5	Unsigned 8	UInt8
6	Unsigned 16	UInt16
7	Unsigned 32	UInt32
9	Visible String	VisStr
33	Normalized value 2 bytes	N2
35	Bit sequence of 16 boolean variables	V2
54	Time difference w/o date	TimD

5.1.2 0- ** Operation and Display

Par. No. #	Parameter description	Default value (SR = Size related)	4-set-up	Change during operation	Conversion index	Type
0-0* Basic Settings						
0-01	Language	[0] English	1 set-up	TRUE	-	Uint8
0-02	Motor Speed Unit	[1] Hz	2 set-ups	FALSE	-	Uint8
0-03	Regional Settings	[0] International	2 set-ups	FALSE	-	Uint8
0-04	Operating State at Power-up	[0] Resume	All set-ups	TRUE	-	Uint8
0-05	Local Mode Unit	[0] As Motor Speed Unit	2 set-ups	FALSE	-	Uint8
0-1* Set-up Operations						
0-10	Active Set-up	[1] Set-up 1	1 set-up	TRUE	-	Uint8
0-11	Programming Set-up	[9] Active Set-up	All set-ups	TRUE	-	Uint8
0-12	This Set-up Linked to	[0] Not linked	All set-ups	FALSE	-	Uint8
0-13	Readout: Linked Set-ups	0 N/A	All set-ups	FALSE	0	Uint16
0-14	Readout: Prog. Set-ups / Channel	0 N/A	All set-ups	TRUE	0	Int32
0-2* LCP Display						
0-20	Display Line 1.1 Small	1602	All set-ups	TRUE	-	Uint16
0-21	Display Line 1.2 Small	1614	All set-ups	TRUE	-	Uint16
0-22	Display Line 1.3 Small	1610	All set-ups	TRUE	-	Uint16
0-23	Display Line 2 Large	1613	All set-ups	TRUE	-	Uint16
0-24	Display Line 3 Large	1502	All set-ups	TRUE	-	Uint16
0-25	My Personal Menu	SR	1 set-up	TRUE	0	Uint16
0-3* LCP Custom Readout						
0-30	Custom Readout Unit	[1] %	All set-ups	TRUE	-	Uint8
0-31	Custom Readout Min Value	SR	All set-ups	TRUE	-2	Int32
0-32	Custom Readout Max Value	100.00 CustomReadoutUnit	All set-ups	TRUE	-2	Int32
0-37	Display Text 1	0 N/A	1 set-up	TRUE	0	VisStr[25]
0-38	Display Text 2	0 N/A	1 set-up	TRUE	0	VisStr[25]
0-39	Display Text 3	0 N/A	1 set-up	TRUE	0	VisStr[25]
0-4* LCP Keypad						
0-40	[Hand on] Key on LCP	[1] Enabled	All set-ups	TRUE	-	Uint8
0-41	[Off] Key on LCP	[1] Enabled	All set-ups	TRUE	-	Uint8
0-42	[Auto on] Key on LCP	[1] Enabled	All set-ups	TRUE	-	Uint8
0-43	[Reset] Key on LCP	[1] Enabled	All set-ups	TRUE	-	Uint8
0-44	[Off/Reset] Key on LCP	[1] Enabled	All set-ups	TRUE	-	Uint8
0-45	[Drive Bypass] Key on LCP	[1] Enabled	All set-ups	TRUE	-	Uint8
0-5* Copy/Save						
0-50	LCP Copy	[0] No copy	All set-ups	FALSE	-	Uint8
0-51	Set-up Copy	[0] No copy	All set-ups	FALSE	-	Uint8

Par. No. #	Parameter description	Default value (SR = Size related)	4-set-up	Change during operation	Conversion index	Type
0-6* Password						
0-60	Main Menu Password	.100 N/A	1 set-up	TRUE	0	Uint16
0-61	Access to Main Menu w/o Password	[0] Full access	1 set-up	TRUE	-	Uint8
0-65	Personal Menu Password	200 N/A	1 set-up	TRUE	0	Uint16
0-66	Access to Personal Menu w/o Password	[0] Full access	1 set-up	TRUE	-	Uint8
0-7* Clock Settings						
0-70	Date and Time	SR	All set-ups	TRUE	0	TimeOfDay
0-71	Date Format	null	1 set-up	TRUE	-	Uint8
0-72	Time Format	null	1 set-up	TRUE	-	Uint8
0-74	DST/Summertime	[0] Off	1 set-up	TRUE	-	Uint8
0-76	DST/Summertime Start	SR	1 set-up	TRUE	0	TimeOfDay
0-77	DST/Summertime End	SR	1 set-up	TRUE	0	TimeOfDay
0-79	Clock Fault	null	1 set-up	TRUE	-	Uint8
0-81	Working Days	null	1 set-up	TRUE	-	Uint8
0-82	Additional Working Days	SR	1 set-up	TRUE	0	TimeOfDay
0-83	Additional Non-Working Days	SR	1 set-up	TRUE	0	TimeOfDay
0-89	Date and Time Readout	0 N/A	All set-ups	TRUE	0	VisStr[25]

5.1.3 1-**-** Load / Motor

Par. No. #	Parameter description	Default value (SR = Size related)	4-set-up	Change during operation	Conversion index	Type
1-0* General Settings						
1-00	Configuration Mode	null	All set-ups	TRUE	-	Uint8
1-03	Torque Characteristics	[3] Auto Energy Optim. VT	All set-ups	TRUE	-	Uint8
1-2* Motor Data						
1-20	Motor Power [kW]	SR	All set-ups	FALSE	1	Uint32
1-21	Motor Power [HP]	SR	All set-ups	FALSE	-2	Uint32
1-22	Motor Voltage	SR	All set-ups	FALSE	0	Uint16
1-23	Motor Frequency	SR	All set-ups	FALSE	0	Uint16
1-24	Motor Current	SR	All set-ups	FALSE	-2	Uint32
1-25	Motor Nominal Speed	SR	All set-ups	FALSE	67	Uint16
1-28	Motor Rotation Check	[0] Off	All set-ups	FALSE	-	Uint8
1-29	Automatic Motor Adaptation (AMA)	[0] Off	All set-ups	FALSE	-	Uint8
1-3* Adv. Motor Data						
1-30	Stator Resistance (Rs)	SR	All set-ups	FALSE	-4	Uint32
1-31	Rotor Resistance (Rr)	SR	All set-ups	FALSE	-4	Uint32
1-35	Main Reactance (Xh)	SR	All set-ups	FALSE	-4	Uint32
1-36	Iron Loss Resistance (Rfe)	SR	All set-ups	FALSE	-3	Uint32
1-39	Motor Poles	SR	All set-ups	FALSE	0	Uint8
1-5* Load Indep. Setting						
1-50	Motor Magnetisation at Zero Speed	100 %	All set-ups	TRUE	0	Uint16
1-51	Min Speed Normal Magnetising [RPM]	SR	All set-ups	TRUE	67	Uint16
1-52	Min Speed Normal Magnetising [Hz]	SR	All set-ups	TRUE	-1	Uint16
1-6* Load Depen. Setting						
1-60	Low Speed Load Compensation	100 %	All set-ups	TRUE	0	Int16
1-61	High Speed Load Compensation	100 %	All set-ups	TRUE	0	Int16
1-62	Slip Compensation	0 %	All set-ups	TRUE	0	Int16
1-63	Slip Compensation Time Constant	SR	All set-ups	TRUE	-2	Uint16
1-64	Resonance Dampening	100 %	All set-ups	TRUE	0	Uint16
1-65	Resonance Dampening Time Constant	5 ms	All set-ups	TRUE	-3	Uint8
1-7* Start Adjustments						
1-71	Start Delay	0.0 s	All set-ups	TRUE	-1	Uint16
1-73	Flying Start	[0] Disabled	All set-ups	FALSE	-	Uint8
1-8* Stop Adjustments						
1-80	Function at Stop	[0] Coast	All set-ups	TRUE	-	Uint8
1-81	Min Speed for Function at Stop [RPM]	SR	All set-ups	TRUE	67	Uint16
1-82	Min Speed for Function at Stop [Hz]	SR	All set-ups	TRUE	-1	Uint16
1-86	Trip Speed Low [RPM]	0 RPM	All set-ups	TRUE	67	Uint16
1-87	Trip Speed Low [Hz]	0.0 Hz	All set-ups	TRUE	-1	Uint16
1-9* Motor Temperature						
1-90	Motor Thermal Protection	[4] ETR trip 1	All set-ups	TRUE	-	Uint8
1-91	Motor External Fan	[0] No	All set-ups	TRUE	-	Uint16
1-93	Thermistor Source	[0] None	All set-ups	TRUE	-	Uint8

5.1.4 2- ** Brakes

Par. No. #	Parameter description	Default value (SR = Size related)	4-set-up	Change during operation	Conversion index	Type
2-0* DC-Brake						
2-00	DC Hold/Preheat Current	50 %	All set-ups	TRUE	0	Uint8
2-01	DC Brake Current	50 %	All set-ups	TRUE	0	Uint16
2-02	DC Braking Time	10.0 s	All set-ups	TRUE	-1	Uint16
2-03	DC Brake Cut In Speed [RPM]	SR	All set-ups	TRUE	67	Uint16
2-04	DC Brake Cut In Speed [Hz]	SR	All set-ups	TRUE	-1	Uint16
2-1* Brake Energy Funct.						
2-10	Brake Function	[0] Off	All set-ups	TRUE	-	Uint8
2-11	Brake Resistor (ohm)	SR	All set-ups	TRUE	0	Uint16
2-12	Brake Power Limit (kW)	SR	All set-ups	TRUE	0	Uint32
2-13	Brake Power Monitoring	[0] Off	All set-ups	TRUE	-	Uint8
2-15	Brake Check	[0] Off	All set-ups	TRUE	-	Uint8
2-16	AC brake Max. Current	100.0 %	All set-ups	TRUE	-1	Uint32
2-17	Over-voltage Control	[2] Enabled	All set-ups	TRUE	-	Uint8

5.1.5 3- ** Reference / Ramps

Par. No. #	Parameter description	Default value (SR = Size related)	4-set-up	Change during operation	Conversion index	Type
3-0* Reference Limits						
3-02	Minimum Reference	SR	All set-ups	TRUE	-3	Int32
3-03	Maximum Reference	SR	All set-ups	TRUE	-3	Int32
3-04	Reference Function	null	All set-ups	TRUE	-	UInt8
3-1* References						
3-10	Preset Reference	0.00 %	All set-ups	TRUE	-2	Int16
3-11	Jog Speed [Hz]	SR	All set-ups	TRUE	-1	UInt16
3-13	Reference Site	[0] Linked to Hand / Auto	All set-ups	TRUE	-	UInt8
3-14	Preset Relative Reference	0.00 %	All set-ups	TRUE	-2	Int32
3-15	Reference 1 Source	[1] Analog input 53	All set-ups	TRUE	-	UInt8
3-16	Reference 2 Source	[20] Digital pot.meter	All set-ups	TRUE	-	UInt8
3-17	Reference 3 Source	[0] No function	All set-ups	TRUE	-	UInt8
3-19	Jog Speed [RPM]	SR	All set-ups	TRUE	67	UInt16
3-4* Ramp 1						
3-41	Ramp 1 Ramp Up Time	SR	All set-ups	TRUE	-2	UInt32
3-42	Ramp 1 Ramp Down Time	SR	All set-ups	TRUE	-2	UInt32
3-5* Ramp 2						
3-51	Ramp 2 Ramp Up Time	SR	All set-ups	TRUE	-2	UInt32
3-52	Ramp 2 Ramp Down Time	SR	All set-ups	TRUE	-2	UInt32
3-8* Other Ramps						
3-80	Jog Ramp Time	SR	All set-ups	TRUE	-2	UInt32
3-81	Quick Stop Ramp Time	SR	2 set-ups	TRUE	-2	UInt32
3-9* Digital Pot.Meter						
3-90	Step Size	0.10 %	All set-ups	TRUE	-2	UInt16
3-91	Ramp Time	1.00 s	All set-ups	TRUE	-2	UInt32
3-92	Power Restore	[0] Off	All set-ups	TRUE	-	UInt8
3-93	Maximum Limit	100 %	All set-ups	TRUE	0	Int16
3-94	Minimum Limit	0 %	All set-ups	TRUE	0	Int16
3-95	Ramp Delay	1.000 N/A	All set-ups	TRUE	-3	TimD

5.1.6 4- * Limits / Warnings

Par. No. #	Parameter description	Default value (SR = Size related)	4-set-up	Change during operation	Conversion index	Type
4-1* Motor Limits						
4-10	Motor Speed Direction	[2] Both directions	All set-ups	FALSE	-	Uint8
4-11	Motor Speed Low Limit [RPM]	SR	All set-ups	TRUE	67	Uint16
4-12	Motor Speed Low Limit [Hz]	SR	All set-ups	TRUE	-1	Uint16
4-13	Motor Speed High Limit [RPM]	SR	All set-ups	TRUE	67	Uint16
4-14	Motor Speed High Limit [Hz]	SR	All set-ups	TRUE	-1	Uint16
4-16	Torque Limit Motor Mode	110.0 %	All set-ups	TRUE	-1	Uint16
4-17	Torque Limit Generator Mode	100.0 %	All set-ups	TRUE	-1	Uint16
4-18	Current Limit	SR	All set-ups	TRUE	-1	Uint32
4-19	Max Output Frequency	SR	All set-ups	FALSE	-1	Uint16
4-5* Adj. Warnings						
4-50	Warning Current Low	0.00 A	All set-ups	TRUE	-2	Uint32
4-51	Warning Current High	ImaxVLT (P1637)	All set-ups	TRUE	-2	Uint32
4-52	Warning Speed Low	0 RPM	All set-ups	TRUE	67	Uint16
4-53	Warning Speed High	outputSpeedHighLimit (P413)	All set-ups	TRUE	67	Uint16
4-54	Warning Reference Low	-999999.999 N/A	All set-ups	TRUE	-3	Int32
4-55	Warning Reference High	999999.999 N/A	All set-ups	TRUE	-3	Int32
4-56	Warning Feedback Low	-999999.999 ProcessCtrlUnit	All set-ups	TRUE	-3	Int32
4-57	Warning Feedback High	999999.999 ProcessCtrlUnit	All set-ups	TRUE	-3	Int32
4-58	Missing Motor Phase Function	[1] On	All set-ups	TRUE	-	Uint8
4-6* Speed Bypass						
4-60	Bypass Speed From [RPM]	SR	All set-ups	TRUE	67	Uint16
4-61	Bypass Speed From [Hz]	SR	All set-ups	TRUE	-1	Uint16
4-62	Bypass Speed To [RPM]	SR	All set-ups	TRUE	67	Uint16
4-63	Bypass Speed To [Hz]	SR	All set-ups	TRUE	-1	Uint16
4-64	Semi-Auto Bypass Set-up	[0] Off	All set-ups	FALSE	-	Uint8

5.1.7 5- * * Digital In / Out

Par. No. #	Parameter description	Default value	4-set-up	Change during operation	Conversion index	Type
5-0* Digital I/O mode						
5-00	Digital I/O Mode	[0] PNP - Active at 24V	All set-ups	FALSE	-	Uint8
5-01	Terminal 27 Mode	[0] Input	All set-ups	TRUE	-	Uint8
5-02	Terminal 29 Mode	[0] Input	All set-ups	TRUE	-	Uint8
5-1* Digital Inputs						
5-10	Terminal 18 Digital Input	[8] Start	All set-ups	TRUE	-	Uint8
5-11	Terminal 19 Digital Input	[0] No operation	All set-ups	TRUE	-	Uint8
5-12	Terminal 27 Digital Input	null	All set-ups	TRUE	-	Uint8
5-13	Terminal 29 Digital Input	[14] Jog	All set-ups	TRUE	-	Uint8
5-14	Terminal 32 Digital Input	[0] No operation	All set-ups	TRUE	-	Uint8
5-15	Terminal 33 Digital Input	[0] No operation	All set-ups	TRUE	-	Uint8
5-16	Terminal X30/2 Digital Input	[0] No operation	All set-ups	TRUE	-	Uint8
5-17	Terminal X30/3 Digital Input	[0] No operation	All set-ups	TRUE	-	Uint8
5-18	Terminal X30/4 Digital Input	[0] No operation	All set-ups	TRUE	-	Uint8
5-3* Digital Outputs						
5-30	Terminal 27 Digital Output	[0] No operation	All set-ups	TRUE	-	Uint8
5-31	Terminal 29 Digital Output	[0] No operation	All set-ups	TRUE	-	Uint8
5-32	Term X30/6 Digi Out (MCB 101)	[0] No operation	All set-ups	TRUE	-	Uint8
5-33	Term X30/7 Digi Out (MCB 101)	[0] No operation	All set-ups	TRUE	-	Uint8
5-4* Relays						
5-40	Function Relay	null	All set-ups	TRUE	-	Uint8
5-41	On Delay, Relay	0.01 s	All set-ups	TRUE	-2	Uint16
5-42	Off Delay, Relay	0.01 s	All set-ups	TRUE	-2	Uint16
5-5* Pulse Input						
5-50	Term. 29 Low Frequency	100 Hz	All set-ups	TRUE	0	Uint32
5-51	Term. 29 High Frequency	100 Hz	All set-ups	TRUE	0	Uint32
5-52	Term. 29 Low Ref./Feedb. Value	0.000 N/A	All set-ups	TRUE	-3	Int32
5-53	Term. 29 High Ref./Feedb. Value	100.000 N/A	All set-ups	TRUE	-3	Int32
5-54	Pulse Filter Time Constant #29	100 ms	All set-ups	FALSE	-3	Uint16
5-55	Term. 33 Low Frequency	100 Hz	All set-ups	TRUE	0	Uint32
5-56	Term. 33 High Frequency	100 Hz	All set-ups	TRUE	0	Uint32
5-57	Term. 33 Low Ref./Feedb. Value	0.000 N/A	All set-ups	TRUE	-3	Int32
5-58	Term. 33 High Ref./Feedb. Value	100.000 N/A	All set-ups	TRUE	-3	Int32
5-59	Pulse Filter Time Constant #33	100 ms	All set-ups	FALSE	-3	Uint16

Par. No. #	Parameter description	Default value	4-set-up	Change during operation	Conversion index	Type
5-6* Pulse Output						
5-60	Terminal 27 Pulse Output Variable	[0] No operation	All set-ups	TRUE	-	Uint8
5-62	Pulse Output Max Freq #27	5000 Hz	All set-ups	TRUE	0	Uint32
5-63	Terminal 29 Pulse Output Variable	[0] No operation	All set-ups	TRUE	-	Uint8
5-65	Pulse Output Max Freq #29	5000 Hz	All set-ups	TRUE	0	Uint32
5-66	Terminal X30/6 Pulse Output Variable	[0] No operation	All set-ups	TRUE	-	Uint8
5-68	Pulse Output Max Freq #X30/6	5000 Hz	All set-ups	TRUE	0	Uint32
5-9* Bus Controlled						
5-90	Digital & Relay Bus Control	0 N/A	All set-ups	TRUE	0	Uint32
5-93	Pulse Out #27 Bus Control	0.00 %	All set-ups	TRUE	-2	N2
5-94	Pulse Out #27 Timeout Preset	0.00 %	1 set-up	TRUE	-2	Uint16
5-95	Pulse Out #29 Bus Control	0.00 %	All set-ups	TRUE	-2	N2
5-96	Pulse Out #29 Timeout Preset	0.00 %	1 set-up	TRUE	-2	Uint16
5-97	Pulse Out #X30/6 Bus Control	0.00 %	All set-ups	TRUE	-2	N2
5-98	Pulse Out #X30/6 Timeout Preset	0.00 %	1 set-up	TRUE	-2	Uint16

5.1.8 6- ** Analog In / Out

Par. No. #	Parameter description	Default value (SR = Size related)	4-set-up	Change during operation	Conversion index	Type
6-0* Analog I/O Mode						
6-00	Live Zero Timeout Time	10 s	All set-ups	TRUE	0	Uint8
6-01	Live Zero Timeout Function	[0] Off	All set-ups	TRUE	-	Uint8
6-02	Fire Mode Live Zero Timeout Function	[0] Off	All set-ups	TRUE	-	Uint8
6-1* Analog Input 53						
6-10	Terminal 53 Low Voltage	0.07 V	All set-ups	TRUE	-2	Int16
6-11	Terminal 53 High Voltage	10.00 V	All set-ups	TRUE	-2	Int16
6-12	Terminal 53 Low Current	4.00 mA	All set-ups	TRUE	-5	Int16
6-13	Terminal 53 High Current	20.00 mA	All set-ups	TRUE	-5	Int16
6-14	Terminal 53 Low Ref./Feedb. Value	0.000 N/A	All set-ups	TRUE	-3	Int32
6-15	Terminal 53 High Ref./Feedb. Value	SR	All set-ups	TRUE	-3	Int32
6-16	Terminal 53 Filter Time Constant	0.001 s	All set-ups	TRUE	-3	Uint16
6-17	Terminal 53 Live Zero	[1] Enabled	All set-ups	TRUE	-	Uint8
6-2* Analog Input 54						
6-20	Terminal 54 Low Voltage	0.07 V	All set-ups	TRUE	-2	Int16
6-21	Terminal 54 High Voltage	10.00 V	All set-ups	TRUE	-2	Int16
6-22	Terminal 54 Low Current	4.00 mA	All set-ups	TRUE	-5	Int16
6-23	Terminal 54 High Current	20.00 mA	All set-ups	TRUE	-5	Int16
6-24	Terminal 54 Low Ref./Feedb. Value	0.000 N/A	All set-ups	TRUE	-3	Int32
6-25	Terminal 54 High Ref./Feedb. Value	100.000 N/A	All set-ups	TRUE	-3	Int32
6-26	Terminal 54 Filter Time Constant	0.001 s	All set-ups	TRUE	-3	Uint16
6-27	Terminal 54 Live Zero	[1] Enabled	All set-ups	TRUE	-	Uint8
6-3* Analog Input X30/11						
6-30	Terminal X30/11 Low Voltage	0.07 V	All set-ups	TRUE	-2	Int16
6-31	Terminal X30/11 High Voltage	10.00 V	All set-ups	TRUE	-2	Int16
6-34	Term. X30/11 Low Ref./Feedb. Value	0.000 N/A	All set-ups	TRUE	-3	Int32
6-35	Term. X30/11 High Ref./Feedb. Value	100.000 N/A	All set-ups	TRUE	-3	Int32
6-36	Term. X30/11 Filter Time Constant	0.001 s	All set-ups	TRUE	-3	Uint16
6-37	Term. X30/11 Live Zero	[1] Enabled	All set-ups	TRUE	-	Uint8
6-4* Analog Input X30/12						
6-40	Terminal X30/12 Low Voltage	0.07 V	All set-ups	TRUE	-2	Int16
6-41	Terminal X30/12 High Voltage	10.00 V	All set-ups	TRUE	-2	Int16
6-44	Term. X30/12 Low Ref./Feedb. Value	0.000 N/A	All set-ups	TRUE	-3	Int32
6-45	Term. X30/12 High Ref./Feedb. Value	100.000 N/A	All set-ups	TRUE	-3	Int32
6-46	Term. X30/12 Filter Time Constant	0.001 s	All set-ups	TRUE	-3	Uint16
6-47	Term. X30/12 Live Zero	[1] Enabled	All set-ups	TRUE	-	Uint8

Par. No. #	Parameter description	Default value	4-set-up	Change during operation	Conversion index	Type
6-5* Analog Output 42						
6-50	Terminal 42 Output	null	All set-ups	TRUE	-	Uint8
6-51	Terminal 42 Output Min Scale	0.00 %	All set-ups	TRUE	-2	Int16
6-52	Terminal 42 Output Max Scale	100.00 %	All set-ups	TRUE	-2	Int16
6-53	Terminal 42 Output Bus Control	0.00 %	All set-ups	TRUE	-2	IN2
6-54	Terminal 42 Output Timeout Preset	0.00 %	1 set-up	TRUE	-2	Uint16
6-6* Analog Output X30/8						
6-60	Terminal X30/8 Output	[0] No operation	All set-ups	TRUE	-	Uint8
6-61	Terminal X30/8 Min. Scale	0.00 %	All set-ups	TRUE	-2	Int16
6-62	Terminal X30/8 Max. Scale	100.00 %	All set-ups	TRUE	-2	Int16
6-63	Terminal X30/8 Output Bus Control	0.00 %	All set-ups	TRUE	-2	IN2
6-64	Terminal X30/8 Output Timeout Preset	0.00 %	1 set-up	TRUE	-2	Uint16

5.1.9 8- ** Communication and Options

Par. No. #	Parameter description	Default value (SR = Size related)	4-set-up	Change during operation	Conversion index	Type
8-0* General Settings						
8-01	Control Site	null	All set-ups	TRUE	-	Uint8
8-02	Control Source	null	All set-ups	TRUE	-	Uint8
8-03	Control Timeout Time	SR	1 set-up	TRUE	-1	Uint32
8-04	Control Timeout Function	[0] Off	1 set-up	TRUE	-	Uint8
8-05	End-of-Timeout Function	[1] Resume set-up	1 set-up	TRUE	-	Uint8
8-06	Reset Control Timeout	[0] Do not reset	All set-ups	TRUE	-	Uint8
8-07	Diagnosis Trigger	[0] Disable	2 set-ups	TRUE	-	Uint8
8-1* Control Settings						
8-10	Control Profile	[0] FC profile	All set-ups	TRUE	-	Uint8
8-13	Configurable Status Word STW	[1] Profile Default	All set-ups	TRUE	-	Uint8
8-3* FC Port Settings						
8-30	Protocol	null	1 set-up	TRUE	-	Uint8
8-31	Address	SR	1 set-up	TRUE	0	Uint8
8-32	Baud Rate	null	1 set-up	TRUE	-	Uint8
8-33	Parity / Stop Bits	null	1 set-up	TRUE	-	Uint8
8-35	Minimum Response Delay	SR	1 set-up	TRUE	-3	Uint16
8-36	Maximum Response Delay	SR	1 set-up	TRUE	-3	Uint16
8-37	Maximum Inter-Char Delay	SR	1 set-up	TRUE	-5	Uint16
8-4* FC MC protocol set						
8-40	Telegram Selection	[1] Standard telegram 1	2 set-ups	TRUE	-	Uint8
8-5* Digital/Bus						
8-50	Coasting Select	[3] Logic OR	All set-ups	TRUE	-	Uint8
8-52	DC Brake Select	[3] Logic OR	All set-ups	TRUE	-	Uint8
8-53	Start Select	[3] Logic OR	All set-ups	TRUE	-	Uint8
8-54	Reversing Select	null	All set-ups	TRUE	-	Uint8
8-55	Set-up Select	[3] Logic OR	All set-ups	TRUE	-	Uint8
8-56	Preset Reference Select	[3] Logic OR	All set-ups	TRUE	-	Uint8
8-7* BACnet						
8-70	BACnet Device Instance	1 N/A	1 set-up	TRUE	0	Uint32
8-72	MS/TP Max Masters	127 N/A	1 set-up	TRUE	0	Uint8
8-73	MS/TP Max Info Frames	1 N/A	1 set-up	TRUE	0	Uint16
8-74	"I-Am" Service	[0] Send at power-up	1 set-up	TRUE	-	Uint8
8-75	Initialisation Password	SR	1 set-up	TRUE	0	VisStr[20]
8-8* FC Port Diagnostics						
8-80	Bus Message Count	0 N/A	All set-ups	TRUE	0	Uint32
8-81	Bus Error Count	0 N/A	All set-ups	TRUE	0	Uint32
8-82	Slave Messages Rcvd	0 N/A	All set-ups	TRUE	0	Uint32
8-83	Slave Error Count	0 N/A	All set-ups	TRUE	0	Uint32
8-89	Diagnostics Count	0 N/A	1 set-up	TRUE	0	Uint32
8-9* Bus Jog / Feedback						
8-90	Bus Jog 1 Speed	100 RPM	All set-ups	TRUE	67	Uint16
8-91	Bus Jog 2 Speed	200 RPM	All set-ups	TRUE	67	Uint16
8-94	Bus Feedback 1	0 N/A	1 set-up	TRUE	0	N2
8-95	Bus Feedback 2	0 N/A	1 set-up	TRUE	0	N2
8-96	Bus Feedback 3	0 N/A	1 set-up	TRUE	0	N2

5.1.10 9- * * Profibus

Par. No. #	Parameter description	Default value (SR = Size related)	4-set-up	Change during operation	Conversion index	Type
9-00	Setpoint	0 N/A	All set-ups	TRUE	0	Uint16
9-07	Actual Value	0 N/A	All set-ups	FALSE	0	Uint16
9-15	PCD Write Configuration	SR	2 set-ups	TRUE	-	Uint16
9-16	PCD Read Configuration	SR	2 set-ups	TRUE	-	Uint16
9-18	Node Address	126 N/A	1 set-up	TRUE	0	Uint8
9-22	Telegram Selection	[108] PPO 8	1 set-up	TRUE	-	Uint8
9-23	Parameters for Signals	0	All set-ups	TRUE	-	Uint16
9-27	Parameter Edit	[1] Enabled	2 set-ups	FALSE	-	Uint16
9-28	Process Control	[1] Enable cyclic master	2 set-ups	FALSE	-	Uint8
9-44	Fault Message Counter	0 N/A	All set-ups	TRUE	0	Uint16
9-45	Fault Code	0 N/A	All set-ups	TRUE	0	Uint16
9-47	Fault Number	0 N/A	All set-ups	TRUE	0	Uint16
9-52	Fault Situation Counter	0 N/A	All set-ups	TRUE	0	Uint16
9-53	Profibus Warning Word	0 N/A	All set-ups	TRUE	0	V2
9-63	Actual Baud Rate	[255] No baudrate found	All set-ups	TRUE	-	Uint8
9-64	Device Identification	0 N/A	All set-ups	TRUE	0	Uint16
9-65	Profile Number	0 N/A	All set-ups	TRUE	0	OctStr[2]
9-67	Control Word 1	0 N/A	All set-ups	TRUE	0	V2
9-68	Status Word 1	0 N/A	All set-ups	TRUE	0	V2
9-71	Profibus Save Data Values	[0] Off	All set-ups	TRUE	-	Uint8
9-72	ProfibusDriveReset	[0] No action	1 set-up	FALSE	-	Uint8
9-80	Defined Parameters (1)	0 N/A	All set-ups	FALSE	0	Uint16
9-81	Defined Parameters (2)	0 N/A	All set-ups	FALSE	0	Uint16
9-82	Defined Parameters (3)	0 N/A	All set-ups	FALSE	0	Uint16
9-83	Defined Parameters (4)	0 N/A	All set-ups	FALSE	0	Uint16
9-84	Defined Parameters (5)	0 N/A	All set-ups	FALSE	0	Uint16
9-90	Changed Parameters (1)	0 N/A	All set-ups	FALSE	0	Uint16
9-91	Changed Parameters (2)	0 N/A	All set-ups	FALSE	0	Uint16
9-92	Changed Parameters (3)	0 N/A	All set-ups	FALSE	0	Uint16
9-93	Changed Parameters (4)	0 N/A	All set-ups	FALSE	0	Uint16
9-94	Changed Parameters (5)	0 N/A	All set-ups	FALSE	0	Uint16

5.1.11 10- * * CAN Fieldbus

Par. No. #	Parameter description	Default value (SR = Size related)	4-set-up	Change during operation	Conversion index	Type
10-0* Common Settings						
10-00	CAN Protocol	null	2 set-ups	FALSE	-	Uint8
10-01	Baud Rate Select	null	2 set-ups	TRUE	-	Uint8
10-02	MAC ID	SR	2 set-ups	TRUE	0	Uint8
10-05	Readout Transmit Error Counter	0 N/A	All set-ups	TRUE	0	Uint8
10-06	Readout Receive Error Counter	0 N/A	All set-ups	TRUE	0	Uint8
10-07	Readout Bus Off Counter	0 N/A	All set-ups	TRUE	0	Uint8
10-1* DeviceNet						
10-10	Process Data Type Selection	null	All set-ups	TRUE	-	Uint8
10-11	Process Data Config Write	SR	2 set-ups	TRUE	-	Uint16
10-12	Process Data Config Read	SR	2 set-ups	TRUE	-	Uint16
10-13	Warning Parameter	0 N/A	All set-ups	TRUE	0	Uint16
10-14	Net Reference	[0] Off	2 set-ups	TRUE	-	Uint8
10-15	Net Control	[0] Off	2 set-ups	TRUE	-	Uint8
10-2* COS Filters						
10-20	COS Filter 1	0 N/A	All set-ups	FALSE	0	Uint16
10-21	COS Filter 2	0 N/A	All set-ups	FALSE	0	Uint16
10-22	COS Filter 3	0 N/A	All set-ups	FALSE	0	Uint16
10-23	COS Filter 4	0 N/A	All set-ups	FALSE	0	Uint16
10-3* Parameter Access						
10-30	Array Index	0 N/A	2 set-ups	TRUE	0	Uint8
10-31	Store Data Values	[0] Off	All set-ups	TRUE	-	Uint8
10-32	DeviceNet Revision	SR	All set-ups	TRUE	0	Uint16
10-33	Store Always	[0] Off	1 set-up	TRUE	-	Uint8
10-34	DeviceNet Product Code	120 N/A	1 set-up	TRUE	0	Uint16
10-39	DeviceNet F Parameters	0 N/A	All set-ups	TRUE	0	Uint32

5.1.12 11-**-** LonWorks

Par. No. #	Parameter description	Default value	4-set-up	Change during operation	Conversion index	Type
11-0* LonWorks ID						
11-00	Neuron ID	0 N/A	All set-ups	TRUE	0	OctStr[6]
11-1* LON Functions						
11-10	Drive Profile	[0] VSD profile	All set-ups	TRUE	-	Uint8
11-15	LON Warning Word	0 N/A	All set-ups	TRUE	0	Uint16
11-17	XIF Revision	0 N/A	All set-ups	TRUE	0	VisStr[5]
11-18	LonWorks Revision	0 N/A	All set-ups	TRUE	0	VisStr[5]
11-2* LON Param. Access						
11-21	Store Data Values	[0] Off	All set-ups	TRUE	-	Uint8

5.1.13 13-.* Smart Logic Controller

Par. No. #	Parameter description	Default value (SR = Size related)	4-set-up	Change during operation	Conversion index	Type
13-0* SLC Settings						
13-00	SL Controller Mode	null	2 set-ups	TRUE	-	Uint8
13-01	Start Event	null	2 set-ups	TRUE	-	Uint8
13-02	Stop Event	null	2 set-ups	TRUE	-	Uint8
13-03	Reset SLC	[0] Do not reset SLC	All set-ups	TRUE	-	Uint8
13-1* Comparators						
13-10	Comparator Operand	null	2 set-ups	TRUE	-	Uint8
13-11	Comparator Operator	null	2 set-ups	TRUE	-	Uint8
13-12	Comparator Value	SR	2 set-ups	TRUE	-3	Int32
13-2* Timers						
13-20	SL Controller Timer	SR	1 set-up	TRUE	-3	TimD
13-4* Logic Rules						
13-40	Logic Rule Boolean 1	null	2 set-ups	TRUE	-	Uint8
13-41	Logic Rule Operator 1	null	2 set-ups	TRUE	-	Uint8
13-42	Logic Rule Boolean 2	null	2 set-ups	TRUE	-	Uint8
13-43	Logic Rule Operator 2	null	2 set-ups	TRUE	-	Uint8
13-44	Logic Rule Boolean 3	null	2 set-ups	TRUE	-	Uint8
13-5* States						
13-51	SL Controller Event	null	2 set-ups	TRUE	-	Uint8
13-52	SL Controller Action	null	2 set-ups	TRUE	-	Uint8

5.1.14 14- ** Special Functions

Par. No. #	Parameter description	Default value (SR = Size related)	4-set-up	Change during operation	Conversion index	Type
14-0* Inverter Switching						
14-00	Switching Pattern	[0] 60 AVM	All set-ups	TRUE	-	Uint8
14-01	Switching Frequency	null	All set-ups	TRUE	-	Uint8
14-03	Overmodulation	[1] On	All set-ups	FALSE	-	Uint8
14-04	PWM Random	[0] Off	All set-ups	TRUE	-	Uint8
14-1* Mains On/Off						
14-10	Mains Failure	[0] No function	All set-ups	FALSE	-	Uint8
14-11	Mains Voltage at Mains Fault	SR	All set-ups	TRUE	0	Uint16
14-12	Function at Mains Imbalance	[0] Trip	All set-ups	TRUE	-	Uint8
14-2* Reset Functions						
14-20	Reset Mode	null	All set-ups	TRUE	-	Uint8
14-21	Automatic Restart Time	10 s	All set-ups	TRUE	0	Uint16
14-22	Operation Mode	[0] Normal operation	All set-ups	TRUE	-	Uint8
14-23	Typecode Setting	null	2 set-ups	FALSE	-	Uint8
14-25	Trip Delay at Torque Limit	60 s	All set-ups	TRUE	0	Uint8
14-26	Trip Delay at Inverter Fault	SR	All set-ups	TRUE	0	Uint8
14-28	Production Settings	[0] No action	All set-ups	TRUE	-	Uint8
14-29	Service Code	0 N/A	All set-ups	TRUE	0	Int32
14-3* Current Limit Ctrl.						
14-30	Current Lim Ctrl, Proportional Gain	100 %	All set-ups	FALSE	0	Uint16
14-31	Current Lim Ctrl, Integration Time	0.020 s	All set-ups	FALSE	-3	Uint16
14-4* Energy Optimising						
14-40	VT Level	66 %	All set-ups	FALSE	0	Uint8
14-41	AEO Minimum Magnetisation	SR	All set-ups	TRUE	0	Uint8
14-42	Minimum AEO Frequency	10 Hz	All set-ups	TRUE	0	Uint8
14-43	Motor Cosphi	SR	All set-ups	TRUE	-2	Uint16
14-5* Environment						
14-50	RFI Filter	[1] On	1 set-up	FALSE	-	Uint8
14-52	Fan Control	[0] Auto	All set-ups	TRUE	-	Uint8
14-53	Fan Monitor	[1] Warning	All set-ups	TRUE	-	Uint8
14-6* Auto Derate						
14-60	Function at Over Temperature	[0] Trip	All set-ups	TRUE	-	Uint8
14-61	Function at Inverter Overload	[0] Trip	All set-ups	TRUE	-	Uint8
14-62	Inv. Overload Derate Current	95 %	All set-ups	TRUE	0	Uint16

5.1.15 15- * * FC Information

Par. No. #	Parameter description	Default value (SR = Size related)	4-set-up	Change during operation	Conversion index	Type
15-0* Operating Data						
15-00	Operating Hours	0 h	All set-ups	FALSE	74	UInt32
15-01	Running Hours	0 h	All set-ups	FALSE	74	UInt32
15-02	kWh Counter	0 kWh	All set-ups	FALSE	75	UInt32
15-03	Power Up's	0 N/A	All set-ups	FALSE	0	UInt32
15-04	Over Temp's	0 N/A	All set-ups	FALSE	0	UInt16
15-05	Over Volt's	0 N/A	All set-ups	FALSE	0	UInt16
15-06	Reset kWh Counter	[0] Do not reset	All set-ups	TRUE	-	UInt8
15-07	Reset Running Hours Counter	[0] Do not reset	All set-ups	TRUE	-	UInt8
15-08	Number of Starts	0 N/A	All set-ups	FALSE	0	UInt32
15-1* Data Log Settings						
15-10	Logging Source	0	2 set-ups	TRUE	-	UInt16
15-11	Logging Interval	SR	2 set-ups	TRUE	-3	TimID
15-12	Trigger Event	[0] False	1 set-up	TRUE	-	UInt8
15-13	Logging Mode	[0] Log always	2 set-ups	TRUE	-	UInt8
15-14	Samples Before Trigger	50 N/A	2 set-ups	TRUE	0	UInt8
15-2* Historic Log						
15-20	Historic Log: Event	0 N/A	All set-ups	FALSE	0	UInt8
15-21	Historic Log: Value	0 N/A	All set-ups	FALSE	0	UInt32
15-22	Historic Log: Time	0 ms	All set-ups	FALSE	-3	UInt32
15-23	Historic Log: Date and Time	SR	All set-ups	FALSE	0	TimeOfDay
15-3* Alarm Log						
15-30	Alarm Log: Error Code	0 N/A	All set-ups	FALSE	0	UInt8
15-31	Alarm Log: Value	0 N/A	All set-ups	FALSE	0	UInt16
15-32	Alarm Log: Time	0 s	All set-ups	FALSE	0	UInt32
15-33	Alarm Log: Date and Time	SR	All set-ups	FALSE	0	TimeOfDay
15-4* Drive Identification						
15-40	FC Type	0 N/A	All set-ups	FALSE	0	VisStr[6]
15-41	Power Section	0 N/A	All set-ups	FALSE	0	VisStr[20]
15-42	Voltage	0 N/A	All set-ups	FALSE	0	VisStr[20]
15-43	Software Version	0 N/A	All set-ups	FALSE	0	VisStr[5]
15-44	Ordered Typecode String	0 N/A	All set-ups	FALSE	0	VisStr[40]
15-45	Actual Typecode String	0 N/A	All set-ups	FALSE	0	VisStr[40]
15-46	Frequency Converter Ordering No	0 N/A	All set-ups	FALSE	0	VisStr[8]
15-47	Power Card Ordering No	0 N/A	All set-ups	FALSE	0	VisStr[8]
15-48	LCP Id No	0 N/A	All set-ups	FALSE	0	VisStr[20]
15-49	SW ID Control Card	0 N/A	All set-ups	FALSE	0	VisStr[20]
15-50	SW ID Power Card	0 N/A	All set-ups	FALSE	0	VisStr[20]
15-51	Frequency Converter Serial Number	0 N/A	All set-ups	FALSE	0	VisStr[10]
15-53	Power Card Serial Number	0 N/A	All set-ups	FALSE	0	VisStr[19]

Par. No. #	Parameter description	Default value	4-set-up	Change during operation	Conversion index	Type
15-6* Option Ident						
15-60	Option Mounted	0 N/A	All set-ups	FALSE	0	VisStr[30]
15-61	Option SW Version	0 N/A	All set-ups	FALSE	0	VisStr[20]
15-62	Option Ordering No	0 N/A	All set-ups	FALSE	0	VisStr[8]
15-63	Option Serial No	0 N/A	All set-ups	FALSE	0	VisStr[18]
15-70	Option in Slot A	0 N/A	All set-ups	FALSE	0	VisStr[30]
15-71	Slot A Option SW Version	0 N/A	All set-ups	FALSE	0	VisStr[20]
15-72	Option in Slot B	0 N/A	All set-ups	FALSE	0	VisStr[30]
15-73	Slot B Option SW Version	0 N/A	All set-ups	FALSE	0	VisStr[20]
15-74	Option in Slot C0	0 N/A	All set-ups	FALSE	0	VisStr[30]
15-75	Slot C0 Option SW Version	0 N/A	All set-ups	FALSE	0	VisStr[20]
15-76	Option in Slot C1	0 N/A	All set-ups	FALSE	0	VisStr[30]
15-77	Slot C1 Option SW Version	0 N/A	All set-ups	FALSE	0	VisStr[20]
15-9* Parameter Info						
15-92	Defined Parameters	0 N/A	All set-ups	FALSE	0	Uint16
15-93	Modified Parameters	0 N/A	All set-ups	FALSE	0	Uint16
15-98	Drive Identification	0 N/A	All set-ups	FALSE	0	VisStr[40]
15-99	Parameter Metadata	0 N/A	All set-ups	FALSE	0	Uint16

5.1.16 16- ** Data Readouts

Par. No. #	Parameter description	Default value (SR = Size related)	4-set-up	Change during operation	Conversion index	Type
16-0* General Status						
16-00	Control Word	0 N/A	All set-ups	FALSE	0	V2
16-01	Reference [Unit]	0.000 ReferenceFeedbackUnit	All set-ups	FALSE	-3	Int32
16-02	Reference [%]	0.0 %	All set-ups	FALSE	-1	Int16
16-03	Status Word	0 N/A	All set-ups	FALSE	0	V2
16-05	Main Actual Value [%]	0.00 %	All set-ups	FALSE	-2	N2
16-09	Custom Readout	0.00 CustomReadoutUnit	All set-ups	FALSE	-2	Int32
16-1* Motor Status						
16-10	Power [kW]	0.00 kW	All set-ups	FALSE	1	Int32
16-11	Power [hp]	0.00 hp	All set-ups	FALSE	-2	Int32
16-12	Motor Voltage	0.0 V	All set-ups	FALSE	-1	Uint16
16-13	Frequency	0.0 Hz	All set-ups	FALSE	-1	Uint16
16-14	Motor Current	0.00 A	All set-ups	FALSE	-2	Int32
16-15	Frequency [%]	0.00 %	All set-ups	FALSE	-2	N2
16-16	Torque [Nm]	0.0 Nm	All set-ups	FALSE	-1	Int32
16-17	Speed [RPM]	0 RPM	All set-ups	FALSE	67	Int32
16-18	Motor Thermal	0 %	All set-ups	FALSE	0	Uint8
16-22	Torque [%]	0 %	All set-ups	FALSE	0	Int16
16-3* Drive Status						
16-30	DC Link Voltage	0 V	All set-ups	FALSE	0	Uint16
16-32	Brake Energy /s	0.000 kW	All set-ups	FALSE	0	Uint32
16-33	Brake Energy /2 min	0.000 kW	All set-ups	FALSE	0	Uint32
16-34	Heatsink Temp.	0 °C	All set-ups	FALSE	100	Uint8
16-35	Inverter Thermal	0 %	All set-ups	FALSE	0	Uint8
16-36	Inv. Nom. Current	SR	All set-ups	FALSE	-2	Uint32
16-37	Inv. Max. Current	SR	All set-ups	FALSE	-2	Uint32
16-38	SL Controller State	0 N/A	All set-ups	FALSE	0	Uint8
16-39	Control Card Temp.	0 °C	All set-ups	FALSE	100	Uint8
16-40	Logging Buffer Full	[0] No	All set-ups	TRUE	-	Uint8
16-5* Ref. & Feedb.						
16-50	External Reference	0.0 N/A	All set-ups	FALSE	-1	Int16
16-52	Feedback [Unit]	0.000 ProcessCtrlUnit	All set-ups	FALSE	-3	Int32
16-53	Digi Pot Reference	0.00 N/A	All set-ups	FALSE	-2	Int16
16-54	Feedback 1 [Unit]	0.000 ProcessCtrlUnit	All set-ups	FALSE	-3	Int32
16-55	Feedback 2 [Unit]	0.000 ProcessCtrlUnit	All set-ups	FALSE	-3	Int32
16-56	Feedback 3 [Unit]	0.000 ProcessCtrlUnit	All set-ups	FALSE	-3	Int32
16-58	PID Output [%]	0.0 %	All set-ups	TRUE	-1	Int16

Par. No. #	Parameter description	Default value	4-set-up	Change during operation	Conversion index	Type
16-6* Inputs & Outputs						
16-60	Digital Input	0 N/A	All set-ups	FALSE	0	UInt16
16-61	Terminal 53 Switch Setting	[0] Current	All set-ups	FALSE	-	UInt8
16-62	Analog Input 53	0.000 N/A	All set-ups	FALSE	-3	Int32
16-63	Terminal 54 Switch Setting	[0] Current	All set-ups	FALSE	-	UInt8
16-64	Analog Input 54	0.000 N/A	All set-ups	FALSE	-3	Int32
16-65	Analog Output 42 [mA]	0.000 N/A	All set-ups	FALSE	-3	Int16
16-66	Digital Output [bin]	0 N/A	All set-ups	FALSE	0	Int16
16-67	Pulse Input #29 [Hz]	0 N/A	All set-ups	FALSE	0	Int32
16-68	Pulse Input #33 [Hz]	0 N/A	All set-ups	FALSE	0	Int32
16-69	Pulse Output #27 [Hz]	0 N/A	All set-ups	FALSE	0	Int32
16-70	Pulse Output #29 [Hz]	0 N/A	All set-ups	FALSE	0	Int32
16-71	Relay Output [bin]	0 N/A	All set-ups	FALSE	0	Int16
16-72	Counter A	0 N/A	All set-ups	TRUE	0	Int32
16-73	Counter B	0 N/A	All set-ups	TRUE	0	Int32
16-75	Analog In X30/11	0.000 N/A	All set-ups	FALSE	-3	Int32
16-76	Analog In X30/12	0.000 N/A	All set-ups	FALSE	-3	Int32
16-77	Analog Out X30/8 [mA]	0.000 N/A	All set-ups	FALSE	-3	Int16
16-8* Fieldbus & FC Port						
16-80	Fieldbus CTW 1	0 N/A	All set-ups	FALSE	0	V2
16-82	Fieldbus REF 1	0 N/A	All set-ups	FALSE	0	N2
16-84	Comm. Option STW	0 N/A	All set-ups	FALSE	0	V2
16-85	FC Port CTW 1	0 N/A	All set-ups	FALSE	0	V2
16-86	FC Port REF 1	0 N/A	All set-ups	FALSE	0	N2
16-9* Diagnosis Readouts						
16-90	Alarm Word	0 N/A	All set-ups	FALSE	0	UInt32
16-91	Alarm Word 2	0 N/A	All set-ups	FALSE	0	UInt32
16-92	Warning Word	0 N/A	All set-ups	FALSE	0	UInt32
16-93	Warning Word 2	0 N/A	All set-ups	FALSE	0	UInt32
16-94	Ext. Status Word	0 N/A	All set-ups	FALSE	0	UInt32
16-95	Ext. Status Word 2	0 N/A	All set-ups	FALSE	0	UInt32
16-96	Maintenance Word	0 N/A	All set-ups	FALSE	0	UInt32

5.1.17 18- * Info & Readouts

Par. No. #	Parameter description	Default value (SR = Size related)	4-set-up	Change during operation	Conversion index	Type
18-0* Maintenance Log						
18-00	Maintenance Log: Item	0 N/A	All set-ups	FALSE	0	Uint8
18-01	Maintenance Log: Action	0 N/A	All set-ups	FALSE	0	Uint8
18-02	Maintenance Log: Time	0 s	All set-ups	FALSE	0	Uint32
18-03	Maintenance Log: Date and Time	SR	All set-ups	FALSE	0	TimeOfDay
18-1* Fire Mode Log						
18-10	Fire Mode Log: Event	0 N/A	All set-ups	FALSE	0	Uint8
18-11	Fire Mode Log: Time	0 s	All set-ups	FALSE	0	Uint32
18-12	Fire Mode Log: Date and Time	SR	All set-ups	FALSE	0	TimeOfDay
18-3* Inputs & Outputs						
18-30	Analog Input X42/1	0.000 N/A	All set-ups	FALSE	-3	Int32
18-31	Analog Input X42/3	0.000 N/A	All set-ups	FALSE	-3	Int32
18-32	Analog Input X42/5	0.000 N/A	All set-ups	FALSE	-3	Int32
18-33	Analog Out X42/7 [V]	0.000 N/A	All set-ups	FALSE	-3	Int16
18-34	Analog Out X42/9 [V]	0.000 N/A	All set-ups	FALSE	-3	Int16
18-35	Analog Out X42/11 [V]	0.000 N/A	All set-ups	FALSE	-3	Int16

5.1.18 20- ** FC Closed Loop

Par. No. #	Parameter description	Default value (SR = Size related)	4-set-up	Change during operation	Conversion index	Type
20-0* Feedback						
20-00	Feedback 1 Source	[2] Analog input 54	All set-ups	TRUE	-	Uint8
20-01	Feedback 1 Conversion	[0] Linear	All set-ups	FALSE	-	Uint8
20-02	Feedback 1 Source Unit	null	All set-ups	TRUE	-	Uint8
20-03	Feedback 2 Source	[0] No function	All set-ups	TRUE	-	Uint8
20-04	Feedback 2 Conversion	[0] Linear	All set-ups	FALSE	-	Uint8
20-05	Feedback 2 Source Unit	null	All set-ups	TRUE	-	Uint8
20-06	Feedback 3 Source	[0] No function	All set-ups	TRUE	-	Uint8
20-07	Feedback 3 Conversion	[0] Linear	All set-ups	FALSE	-	Uint8
20-08	Feedback 3 Source Unit	null	All set-ups	TRUE	-	Uint8
20-12	Reference/Feedback Unit	null	All set-ups	TRUE	-	Uint8
20-13	Minimum Reference/Feedb.	0.000 ProcessCtrlUnit	All set-ups	TRUE	-3	Int32
20-14	Maximum Reference/Feedb.	100.000 ProcessCtrlUnit	All set-ups	TRUE	-3	Int32
20-2* Feedback/Setpoint						
20-20	Feedback Function	[3] Minimum	All set-ups	TRUE	-	Uint8
20-21	Setpoint 1	0.000 ProcessCtrlUnit	All set-ups	TRUE	-3	Int32
20-22	Setpoint 2	0.000 ProcessCtrlUnit	All set-ups	TRUE	-3	Int32
20-23	Setpoint 3	0.000 ProcessCtrlUnit	All set-ups	TRUE	-3	Int32
20-3* Feedback Adv. Conv						
20-30	Refrigerant	[0] R22	All set-ups	TRUE	-	Uint8
20-31	User Defined Refrigerant A1	10.0000 N/A	All set-ups	TRUE	-4	Uint32
20-32	User Defined Refrigerant A2	-2250.00 N/A	All set-ups	TRUE	-2	Int32
20-33	User Defined Refrigerant A3	250.000 N/A	All set-ups	TRUE	-3	Uint32
20-7* PID Autotuning						
20-70	Closed Loop Type	[0] Auto	2 set-ups	TRUE	-	Uint8
20-71	PID Performance	[0] Normal	2 set-ups	TRUE	-	Uint8
20-72	PID Output Change	0.10 N/A	2 set-ups	TRUE	-2	Uint16
20-73	Minimum Feedback Level	-999999.000 ProcessCtrlUnit	2 set-ups	TRUE	-3	Int32
20-74	Maximum Feedback Level	999999.000 ProcessCtrlUnit	2 set-ups	TRUE	-3	Int32
20-79	PID Autotuning	[0] Disabled	All set-ups	TRUE	-	Uint8
20-8* PID Basic Settings						
20-81	PID Normal/ Inverse Control	[0] Normal	All set-ups	TRUE	-	Uint8
20-82	PID Start Speed [RPM]	SR	All set-ups	TRUE	67	Uint16
20-83	PID Start Speed [Hz]	SR	All set-ups	TRUE	-1	Uint16
20-84	On Reference Bandwidth	5 %	All set-ups	TRUE	0	Uint8
20-9* PID Controller						
20-91	PID Anti Windup	[1] On	All set-ups	TRUE	-	Uint8
20-93	PID Proportional Gain	0.50 N/A	All set-ups	TRUE	-2	Uint16
20-94	PID Integral Time	20.00 s	All set-ups	TRUE	-2	Uint32
20-95	PID Differentiation Time	0.00 s	All set-ups	TRUE	-2	Uint16
20-96	PID Diff. Gain Limit	5.0 N/A	All set-ups	TRUE	-1	Uint16

5.1.19 21- * * Ext. Closed Loop

Par. No. #	Parameter description	Default value	4-set-up	Change during operation	Conversion index	Type
21-0* Ext. CL Autotuning						
21-00	Closed Loop Type	[0] Auto	2 set-ups	TRUE	-	Uint8
21-01	PID Performance	[0] Normal	2 set-ups	TRUE	-	Uint8
21-02	PID Output Change	0.10 N/A	2 set-ups	TRUE	-2	Uint16
21-03	Minimum Feedback Level	-999999.000 N/A	2 set-ups	TRUE	-3	Int32
21-04	Maximum Feedback Level	999999.000 N/A	2 set-ups	TRUE	-3	Int32
21-09	PID Autotuning	[0] Disabled	All set-ups	TRUE	-	Uint8
21-1* Ext. CL 1 Ref./Fb.						
21-10	Ext. 1 Ref./Feedback Unit	[1] %	All set-ups	TRUE	-	Uint8
21-11	Ext. 1 Minimum Reference	0.000 ExtPID1Unit	All set-ups	TRUE	-3	Int32
21-12	Ext. 1 Maximum Reference	100.000 ExtPID1Unit	All set-ups	TRUE	-3	Int32
21-13	Ext. 1 Reference Source	[0] No function	All set-ups	TRUE	-	Uint8
21-14	Ext. 1 Feedback Source	[0] No function	All set-ups	TRUE	-	Uint8
21-15	Ext. 1 Setpoint	0.000 ExtPID1Unit	All set-ups	TRUE	-3	Int32
21-17	Ext. 1 Reference [Unit]	0.000 ExtPID1Unit	All set-ups	TRUE	-3	Int32
21-18	Ext. 1 Feedback [Unit]	0.000 ExtPID1Unit	All set-ups	TRUE	-3	Int32
21-19	Ext. 1 Output [%]	0 %	All set-ups	TRUE	0	Int32
21-2* Ext. CL 1 PID						
21-20	Ext. 1 Normal/Inverse Control	[0] Normal	All set-ups	TRUE	-	Uint8
21-21	Ext. 1 Proportional Gain	0.01 N/A	All set-ups	TRUE	-2	Uint16
21-22	Ext. 1 Integral Time	10000.00 s	All set-ups	TRUE	-2	Uint32
21-23	Ext. 1 Differentiation Time	0.00 s	All set-ups	TRUE	-2	Uint16
21-24	Ext. 1 Dif. Gain Limit	5.0 N/A	All set-ups	TRUE	-1	Uint16
21-3* Ext. CL 2 Ref./Fb.						
21-30	Ext. 2 Ref./Feedback Unit	[1] %	All set-ups	TRUE	-	Uint8
21-31	Ext. 2 Minimum Reference	0.000 ExtPID2Unit	All set-ups	TRUE	-3	Int32
21-32	Ext. 2 Maximum Reference	100.000 ExtPID2Unit	All set-ups	TRUE	-3	Int32
21-33	Ext. 2 Reference Source	[0] No function	All set-ups	TRUE	-	Uint8
21-34	Ext. 2 Feedback Source	[0] No function	All set-ups	TRUE	-	Uint8
21-35	Ext. 2 Setpoint	0.000 ExtPID2Unit	All set-ups	TRUE	-3	Int32
21-37	Ext. 2 Reference [Unit]	0.000 ExtPID2Unit	All set-ups	TRUE	-3	Int32
21-38	Ext. 2 Feedback [Unit]	0.000 ExtPID2Unit	All set-ups	TRUE	-3	Int32
21-39	Ext. 2 Output [%]	0 %	All set-ups	TRUE	0	Int32
21-4* Ext. CL 2 PID						
21-40	Ext. 2 Normal/Inverse Control	[0] Normal	All set-ups	TRUE	-	Uint8
21-41	Ext. 2 Proportional Gain	0.01 N/A	All set-ups	TRUE	-2	Uint16
21-42	Ext. 2 Integral Time	10000.00 s	All set-ups	TRUE	-2	Uint32
21-43	Ext. 2 Differentiation Time	0.00 s	All set-ups	TRUE	-2	Uint16
21-44	Ext. 2 Dif. Gain Limit	5.0 N/A	All set-ups	TRUE	-1	Uint16

Par. No. #	Parameter description	Default value	4-set-up	Change during operation	Conversion index	Type
21-5*	Ext. CL 3 Ref./Fb.					
21-50	Ext. 3 Ref./Feedback Unit	[1] %	All set-ups	TRUE	-	Uint8
21-51	Ext. 3 Minimum Reference	0.000 ExtPID3Unit	All set-ups	TRUE	-3	Int32
21-52	Ext. 3 Maximum Reference	100.000 ExtPID3Unit	All set-ups	TRUE	-3	Int32
21-53	Ext. 3 Reference Source	[0] No function	All set-ups	TRUE	-	Uint8
21-54	Ext. 3 Feedback Source	[0] No function	All set-ups	TRUE	-	Uint8
21-55	Ext. 3 Setpoint	0.000 ExtPID3Unit	All set-ups	TRUE	-3	Int32
21-57	Ext. 3 Reference [Unit]	0.000 ExtPID3Unit	All set-ups	TRUE	-3	Int32
21-58	Ext. 3 Feedback [Unit]	0.000 ExtPID3Unit	All set-ups	TRUE	-3	Int32
21-59	Ext. 3 Output [%]	0 %	All set-ups	TRUE	0	Int32
21-6*	Ext. CL 3 PID					
21-60	Ext. 3 Normal/Inverse Control	[0] Normal	All set-ups	TRUE	-	Uint8
21-61	Ext. 3 Proportional Gain	0.01 N/A	All set-ups	TRUE	-2	Uint16
21-62	Ext. 3 Integral Time	10000.00 s	All set-ups	TRUE	-2	Uint32
21-63	Ext. 3 Differentiation Time	0.00 s	All set-ups	TRUE	-2	Uint16
21-64	Ext. 3 Dif. Gain Limit	5.0 N/A	All set-ups	TRUE	-1	Uint16

5.1.20 22- * Application Functions

Par. No. #	Parameter description	Default value (SR = Size related)	4-set-up	Change during operation	Conversion index	Type
22-0* Miscellaneous						
22-00	External Interlock Delay	0 s	All set-ups	TRUE	0	Uint16
22-2* No-Flow Detection						
22-20	Low Power Auto Set-up	[0] Off	All set-ups	FALSE	-	Uint8
22-21	Low Power Detection	[0] Disabled	All set-ups	TRUE	-	Uint8
22-22	Low Speed Detection	[0] Disabled	All set-ups	TRUE	-	Uint8
22-23	No-Flow Function	[0] Off	All set-ups	TRUE	-	Uint8
22-24	No-Flow Delay	10 s	All set-ups	TRUE	0	Uint16
22-26	Dry Pump Function	[0] Off	All set-ups	TRUE	-	Uint8
22-27	Dry Pump Delay	10 s	All set-ups	TRUE	0	Uint16
22-3* No-Flow Power Tuning						
22-30	No-Flow Power	0.00 kW	All set-ups	TRUE	1	Uint32
22-31	Power Correction Factor	100 %	All set-ups	TRUE	0	Uint16
22-32	Low Speed [RPM]	SR	All set-ups	TRUE	67	Uint16
22-33	Low Speed [Hz]	SR	All set-ups	TRUE	-1	Uint16
22-34	Low Speed Power [kW]	SR	All set-ups	TRUE	1	Uint32
22-35	Low Speed Power [HP]	SR	All set-ups	TRUE	-2	Uint32
22-36	High Speed [RPM]	SR	All set-ups	TRUE	67	Uint16
22-37	High Speed [Hz]	SR	All set-ups	TRUE	-1	Uint16
22-38	High Speed Power [kW]	SR	All set-ups	TRUE	1	Uint32
22-39	High Speed Power [HP]	SR	All set-ups	TRUE	-2	Uint32
22-4* Sleep Mode						
22-40	Minimum Run Time	10 s	All set-ups	TRUE	0	Uint16
22-41	Minimum Sleep Time	10 s	All set-ups	TRUE	0	Uint16
22-42	Wake-up Speed [RPM]	SR	All set-ups	TRUE	67	Uint16
22-43	Wake-up Speed [Hz]	SR	All set-ups	TRUE	-1	Uint16
22-44	Wake-up Ref./FB Difference	10 %	All set-ups	TRUE	0	Int8
22-45	Setpoint Boost	0 %	All set-ups	TRUE	0	Int8
22-46	Maximum Boost Time	60 s	All set-ups	TRUE	0	Uint16
22-5* End of Curve						
22-50	End of Curve Function	[0] Off	All set-ups	TRUE	-	Uint8
22-51	End of Curve Delay	10 s	All set-ups	TRUE	0	Uint16
22-6* Broken Belt Detection						
22-60	Broken Belt Function	[0] Off	All set-ups	TRUE	-	Uint8
22-61	Broken Belt Torque	10 %	All set-ups	TRUE	0	Uint8
22-62	Broken Belt Delay	10 s	All set-ups	TRUE	0	Uint16
22-7* Short Cycle Protection						
22-75	Short Cycle Protection	[0] Disabled	All set-ups	TRUE	-	Uint8
22-76	Interval between Starts	start_to_start_min_on_time (P2277)	All set-ups	TRUE	0	Uint16
22-77	Minimum Run Time	0 s	All set-ups	TRUE	0	Uint16

Par. No. #	Parameter description	Default value (SR = Size related)	4-set-up	Change during operation	Conversion index	Type
22-8* Flow Compensation						
22-80	Flow Compensation	[0] Disabled	All set-ups	TRUE	-	Uint8
22-81	Square-linear Curve Approximation	100 %	All set-ups	TRUE	0	Uint8
22-82	Work Point Calculation	[0] Disabled	All set-ups	TRUE	-	Uint8
22-83	Speed at No-Flow [RPM]	SR	All set-ups	TRUE	67	Uint16
22-84	Speed at No-Flow [Hz]	SR	All set-ups	TRUE	-1	Uint16
22-85	Speed at Design Point [RPM]	SR	All set-ups	TRUE	67	Uint16
22-86	Speed at Design Point [Hz]	SR	All set-ups	TRUE	-1	Uint16
22-87	Pressure at No-Flow Speed	0.000 N/A	All set-ups	TRUE	-3	Int32
22-88	Pressure at Rated Speed	999999.999 N/A	All set-ups	TRUE	-3	Int32
22-89	Flow at Design Point	0.000 N/A	All set-ups	TRUE	-3	Int32
22-90	Flow at Rated Speed	0.000 N/A	All set-ups	TRUE	-3	Int32

5.1.21 23- * * Time Based Functions

Par. No. #	Parameter description	Default value (SR = Size related)	4-set-up	Change during operation	Conversion index	Type
23-0* Timed Actions						
23-00	ON Time	SR	2 set-ups	TRUE	0	TimeOfDay- WoDate
23-01	ON Action	[0] Disabled	2 set-ups	TRUE	-	Uint8
23-02	OFF Time	SR	2 set-ups	TRUE	0	TimeOfDay- WoDate
23-03	OFF Action	[0] Disabled	2 set-ups	TRUE	-	Uint8
23-04	Occurrence	[0] All days	2 set-ups	TRUE	-	Uint8
23-1* Maintenance						
23-10	Maintenance Item	[1] Motor bearings	1 set-up	TRUE	-	Uint8
23-11	Maintenance Action	[1] Lubricate	1 set-up	TRUE	-	Uint8
23-12	Maintenance Time Base	[0] Disabled	1 set-up	TRUE	-	Uint8
23-13	Maintenance Time Interval	1 h	1 set-up	TRUE	74	Uint32
23-14	Maintenance Date and Time	SR	1 set-up	TRUE	0	TimeOfDay
23-1* Maintenance Reset						
23-15	Reset Maintenance Word	[0] Do not reset	All set-ups	TRUE	-	Uint8
23-16	Maintenance Text	0 N/A	1 set-up	TRUE	0	VisStr[20]
23-5* Energy Log						
23-50	Energy Log Resolution	[5] Last 24 Hours	2 set-ups	TRUE	-	Uint8
23-51	Period Start	SR	2 set-ups	TRUE	0	TimeOfDay
23-53	Energy Log	0 N/A	All set-ups	TRUE	0	Uint32
23-54	Reset Energy Log	[0] Do not reset	All set-ups	TRUE	-	Uint8
23-6* Trending						
23-60	Trend Variable	[0] Power [kW]	2 set-ups	TRUE	-	Uint8
23-61	Continuous Bin Data	0 N/A	All set-ups	TRUE	0	Uint32
23-62	Timed Bin Data	0 N/A	All set-ups	TRUE	0	Uint32
23-63	Timed Period Start	SR	2 set-ups	TRUE	0	TimeOfDay
23-64	Timed Period Stop	SR	2 set-ups	TRUE	0	TimeOfDay
23-65	Minimum Bin Value	SR	2 set-ups	TRUE	0	Uint8
23-66	Reset Continuous Bin Data	[0] Do not reset	All set-ups	TRUE	-	Uint8
23-67	Reset Timed Bin Data	[0] Do not reset	All set-ups	TRUE	-	Uint8
23-8* Payback Counter						
23-80	Power Reference Factor	100 %	2 set-ups	TRUE	0	Uint8
23-81	Energy Cost	1.00 N/A	2 set-ups	TRUE	-2	Uint32
23-82	Investment	0 N/A	2 set-ups	TRUE	0	Uint32
23-83	Energy Savings	0 kWh	All set-ups	TRUE	75	Int32
23-84	Cost Savings	0 N/A	All set-ups	TRUE	0	Int32

5.1.22 24- ** Application Functions 2

Par. No. #	Parameter description	Default value (SR = Size related)	4-set-up	Change during operation	Conversion index	Type
24-0* Fire Mode						
24-00	Fire Mode Function	[0] Disabled	2 set-ups	TRUE	-	Uint8
24-01	Fire Mode Configuration	[0] Open Loop	All set-ups	TRUE	-	Uint8
24-02	Fire Mode Unit	null	All set-ups	TRUE	-	Uint8
24-03	Fire Mode Min Reference	SR	All set-ups	TRUE	-3	Int32
24-04	Fire Mode Max Reference	SR	All set-ups	TRUE	-3	Int32
24-05	Fire Mode Preset Reference	0.00 %	All set-ups	TRUE	-2	Int16
24-06	Fire Mode Reference Source	[0] No function	All set-ups	TRUE	-	Uint8
24-07	Fire Mode Feedback Source	[0] No function	All set-ups	TRUE	-	Uint8
24-09	Fire Mode Alarm Handling	[1] Trip, Critical Alarms	2 set-ups	FALSE	-	Uint8
24-1* Drive Bypass						
24-10	Drive Bypass Function	[0] Disabled	2 set-ups	TRUE	-	Uint8
24-11	Drive Bypass Delay Time	0 s	2 set-ups	TRUE	0	Uint16

5.1.23 25- * Cascade Controller

Par. No. #	Parameter description	Default value (SR = Size related)	4-set-up	Change during operation	Conversion index	Type
25-0* System Settings						
25-00	Cascade Controller	[0] Disabled	2 set-ups	FALSE	-	Uint8
25-02	Motor Start	[0] Direct on Line	2 set-ups	FALSE	-	Uint8
25-04	Pump Cycling	[0] Disabled	All set-ups	TRUE	-	Uint8
25-05	Fixed Lead Pump	[1] Yes	2 set-ups	FALSE	-	Uint8
25-06	Number of Pumps	2 N/A	2 set-ups	FALSE	0	Uint8
25-2* Bandwidth Settings						
25-20	Staging Bandwidth	10 %	All set-ups	TRUE	0	Uint8
25-21	Override Bandwidth	100 %	All set-ups	TRUE	0	Uint8
25-22	Fixed Speed Bandwidth	casco_staging_bandwidth (P2520)	All set-ups	TRUE	0	Uint8
25-23	SBW Staging Delay	15 s	All set-ups	TRUE	0	Uint16
25-24	SBW Destaging Delay	15 s	All set-ups	TRUE	0	Uint16
25-25	OBW Time	10 s	All set-ups	TRUE	0	Uint16
25-26	Destage At No-Flow	[0] Disabled	All set-ups	TRUE	-	Uint8
25-27	Stage Function	[1] Enabled	All set-ups	TRUE	-	Uint8
25-28	Stage Function Time	15 s	All set-ups	TRUE	0	Uint16
25-29	Destage Function	[1] Enabled	All set-ups	TRUE	-	Uint8
25-30	Destage Function Time	15 s	All set-ups	TRUE	0	Uint16
25-4* Staging Settings						
25-40	Ramp Down Delay	10.0 s	All set-ups	TRUE	-1	Uint16
25-41	Ramp Up Delay	2.0 s	All set-ups	TRUE	-1	Uint16
25-42	Staging Threshold	SR	All set-ups	TRUE	0	Uint8
25-43	Destaging Threshold	SR	All set-ups	TRUE	0	Uint8
25-44	Staging Speed [RPM]	0 RPM	All set-ups	TRUE	67	Uint16
25-45	Staging Speed [Hz]	0.0 Hz	All set-ups	TRUE	-1	Uint16
25-46	Destaging Speed [RPM]	0 RPM	All set-ups	TRUE	67	Uint16
25-47	Destaging Speed [Hz]	0.0 Hz	All set-ups	TRUE	-1	Uint16
25-5* Alternation Settings						
25-50	Lead Pump Alternation	[0] Off	All set-ups	TRUE	-	Uint8
25-51	Alternation Event	[0] External	All set-ups	TRUE	-	Uint8
25-52	Alternation Time Interval	24 h	All set-ups	TRUE	74	Uint16
25-53	Alternation Timer Value	0 N/A	All set-ups	TRUE	0	VisStr[7]
25-54	Alternation Predefined Time	SR	All set-ups	TRUE	0	TimeOfDay-
25-55	Alternate if Load < 50%	[1] Enabled	All set-ups	TRUE	-	Uint8
25-56	Staging Mode at Alternation	[0] Slow	All set-ups	TRUE	-	Uint8
25-58	Run Next Pump Delay	0.1 s	All set-ups	TRUE	-1	Uint16
25-59	Run on Mains Delay	0.5 s	All set-ups	TRUE	-1	Uint16

Par. No. #	Parameter description	Default value	4-set-up	Change during operation	Conversion index	Type
25-8* Status						
25-80	Cascade Status	0 N/A	All set-ups	TRUE	0	VisStr[25]
25-81	Pump Status	0 N/A	All set-ups	TRUE	0	VisStr[25]
25-82	Lead Pump	0 N/A	All set-ups	TRUE	0	Uint8
25-83	Relay Status	0 N/A	All set-ups	TRUE	0	VisStr[4]
25-84	Pump ON Time	0 h	All set-ups	TRUE	74	Uint32
25-85	Relay ON Time	0 h	All set-ups	TRUE	74	Uint32
25-86	Reset Relay Counters	[0] Do not reset	All set-ups	TRUE	-	Uint8
25-9* Service						
25-90	Pump Interlock	[0] Off	All set-ups	TRUE	-	Uint8
25-91	Manual Alternation	0 N/A	All set-ups	TRUE	0	Uint8

5.1.24 26- * Analog I / O Option MCB 109

Par. No. #	Parameter description	Default value	4-set-up	Change during operation	Conversion index	Type
26-0* Analog I/O Mode						
26-00	Terminal X42/1 Mode	[1] Voltage	All set-ups	TRUE	-	Uint8
26-01	Terminal X42/3 Mode	[1] Voltage	All set-ups	TRUE	-	Uint8
26-02	Terminal X42/5 Mode	[1] Voltage	All set-ups	TRUE	-	Uint8
26-1* Analog Input X42/1						
26-10	Terminal X42/1 Low Voltage	0.07 V	All set-ups	TRUE	-2	Int16
26-11	Terminal X42/1 High Voltage	10.00 V	All set-ups	TRUE	-2	Int16
26-14	Term. X42/1 Low Ref./Feedb. Value	0.000 N/A	All set-ups	TRUE	-3	Int32
26-15	Term. X42/1 High Ref./Feedb. Value	100.000 N/A	All set-ups	TRUE	-3	Int32
26-16	Term. X42/1 Filter Time Constant	0.001 s	All set-ups	TRUE	-3	Uint16
26-17	Term. X42/1 Live Zero	[1] Enabled	All set-ups	TRUE	-	Uint8
26-2* Analog Input X42/3						
26-20	Terminal X42/3 Low Voltage	0.07 V	All set-ups	TRUE	-2	Int16
26-21	Terminal X42/3 High Voltage	10.00 V	All set-ups	TRUE	-2	Int16
26-24	Term. X42/3 Low Ref./Feedb. Value	0.000 N/A	All set-ups	TRUE	-3	Int32
26-25	Term. X42/3 High Ref./Feedb. Value	100.000 N/A	All set-ups	TRUE	-3	Int32
26-26	Term. X42/3 Filter Time Constant	0.001 s	All set-ups	TRUE	-3	Uint16
26-27	Term. X42/3 Live Zero	[1] Enabled	All set-ups	TRUE	-	Uint8
26-3* Analog Input X42/5						
26-30	Terminal X42/5 Low Voltage	0.07 V	All set-ups	TRUE	-2	Int16
26-31	Terminal X42/5 High Voltage	10.00 V	All set-ups	TRUE	-2	Int16
26-34	Term. X42/5 Low Ref./Feedb. Value	0.000 N/A	All set-ups	TRUE	-3	Int32
26-35	Term. X42/5 High Ref./Feedb. Value	100.000 N/A	All set-ups	TRUE	-3	Int32
26-36	Term. X42/5 Filter Time Constant	0.001 s	All set-ups	TRUE	-3	Uint16
26-37	Term. X42/5 Live Zero	[1] Enabled	All set-ups	TRUE	-	Uint8
26-4* Analog Out X42/7						
26-40	Terminal X42/7 Output	[0] No operation	All set-ups	TRUE	-	Uint8
26-41	Terminal X42/7 Min. Scale	0.00 %	All set-ups	TRUE	-2	Int16
26-42	Terminal X42/7 Max. Scale	100.00 %	All set-ups	TRUE	-2	Int16
26-43	Terminal X42/7 Bus Control	0.00 %	All set-ups	TRUE	-2	N2
26-44	Terminal X42/7 Timeout Preset	0.00 %	1 set-up	TRUE	-2	Uint16
26-5* Analog Out X42/9						
26-50	Terminal X42/9 Output	[0] No operation	All set-ups	TRUE	-	Uint8
26-51	Terminal X42/9 Min. Scale	0.00 %	All set-ups	TRUE	-2	Int16
26-52	Terminal X42/9 Max. Scale	100.00 %	All set-ups	TRUE	-2	Int16
26-53	Terminal X42/9 Bus Control	0.00 %	All set-ups	TRUE	-2	N2
26-54	Terminal X42/9 Timeout Preset	0.00 %	1 set-up	TRUE	-2	Uint16
26-6* Analog Out X42/11						
26-60	Terminal X42/11 Output	[0] No operation	All set-ups	TRUE	-	Uint8
26-61	Terminal X42/11 Min. Scale	0.00 %	All set-ups	TRUE	-2	Int16
26-62	Terminal X42/11 Max. Scale	100.00 %	All set-ups	TRUE	-2	Int16
26-63	Terminal X42/11 Bus Control	0.00 %	All set-ups	TRUE	-2	N2
26-64	Terminal X42/11 Timeout Preset	0.00 %	1 set-up	TRUE	-2	Uint16

Index

"

"i-am" Service 8-74	112
---------------------	-----

1

1-3* Adv. Motor Data	43
18-0* Maintenance Log	165

2

20-** Fc Closed Loop	167
20-0* Feedback	168
20-2* Feedback & Setpoint	175
20-3* Feedback Adv. Conversion	178
20-7* Pid Autotuning	179
20-8* Basic Settings	181
20-9* Pid Controller	182
21-0* Extended CI Autotuning	183
22-2* No-flow Detection	195
22-8* Flow Compensation	206
24-0* Fire Mode	225
24-1* Drive Bypass	230
25-** Cascade Controller	232

5

5-1* Digital Inputs	66
5-6* Pulse Outputs	92

6

6-0* Analog I/o Mode	95
----------------------	----

8

8-7* Bacnet	111
-------------	-----

A

Acceleration Time	57
Access To Main Menu W/o Password 0-61	36
Access To Personal Menu W/o Password 0-66	37
Active Set-up 0-10	26
Actual Baud Rate 9-63	119
Actual Typecode String 15-45	158
Additional Non-working Days 0-83	39
Additional Working Days 0-82	38
Address 8-31	108
Aeo Minimum Magnetisation 14-41	150
Alarm Log	157
Alarm Log: Error Code 15-30	157
Alarm Log: Time 15-32	157
Alarm Log: Value 15-31	157
Alarm Word	258
Alarm Word 16-90	165
Alarm Word 2 16-91	165
Alarms And Warnings	255
Alternate If Load < 50% 25-55	242
Alternation Event 25-51	242
Alternation Predefined Time 25-54	242
Alternation Time Interval 25-52	242
Alternation Timer Value 25-53	242
Analog I/o Option Mcb 109, 26-**	245
Analog In X30/11 16-75	164
Analog In X30/12 16-76	164
Analog Input 53 16-62	163

Analog Input 54 16-64	163
Analog Input Scaling Value	249
Analog Input X42/1 18-30	167
Analog Input X42/3 18-31	167
Analog Input X42/5 18-32	167
[Analog Out X30/8 Ma] 16-77	164
[Analog Out X42/11 V] 18-35	167
[Analog Out X42/7 V] 18-33	167
[Analog Out X42/9 V] 18-34	167
[Analog Output 42 Ma] 16-65	163
Array Index 10-30	127
Auto Derate, 14-6*	150
Auto Energy Optimization Compressor	40
Auto Energy Optimization Vt	40
[Auto On] Key On Lcp 0-42	35
Automatic Motor Adaptation (ama) 1-29	42
Automatic Restart Time 14-21	147

B

Bacnet Device Instance 8-70	111
Baud Rate 8-32	108
Baud Rate Select 10-01	122
Brake Check 2-15	52
Brake Energy /2 Min 16-33	161
Brake Energy /s 16-32	161
Brake Function 2-10	51
Brake Power Limit (kw) 2-12	51
Brake Power Monitoring 2-13	51
Brake Resistor (ohm) 2-11	51
Broken Belt Delay 22-62	205
Broken Belt Detection	204
Broken Belt Function 22-60	204
Broken Belt Torque 22-61	205
Bus Controlled	94
Bus Error Count 8-81	112
Bus Feedback 1 8-94	113
Bus Feedback 2 8-95	113
Bus Feedback 3 8-96	113
Bus Jog 1 Speed 8-90	113
Bus Jog 2 Speed 8-91	113
Bus Message Count 8-80	112
[Bypass Speed From Hz] 4-61	64
[Bypass Speed From Rpm] 4-60	64
[Bypass Speed To Hz] 4-63	64
[Bypass Speed To Rpm] 4-62	64

C

Can Protocol 10-00	122
Cascade Controller 25-00	233
Cascade Status 25-80	244
Changed Parameters (1) 9-90	121
Changed Parameters (2) 9-91	121
Changed Parameters (3) 9-92	121
Changed Parameters (5) 9-94	122
Changes Made	14
Changing A Data Value	21
Changing A Group Of Numeric Data Values	21
Changing A Text Value	20
Changing Data	20
Changing Parameter Data	13
Clock Fault 0-79	38
Clock Settings, 0-7*	37
Closed Loop Type 20-70	180, 184
Coast Inverse	15
Coasting	9
Coasting Select 8-50	109
Comm. Option Stw 16-84	164

Communication Option	262
Comparator Operand 13-10	133
Comparator Operator 13-11	133
Comparator Value 13-12	134
Configurable Status Word Stw 8-13	107
Configuration	107
Configuration Mode 1-00	39
Continuous Bin Data 23-61	222
Control Card Temp. 16-39	162
Control Profile 8-10	107
Control Site 8-01	105
Control Source 8-02	105
Control Timeout Function 8-04	106
Control Timeout Time 8-03	106
Control Word 16-00	159
Cooling	48
Cos Filter 1 10-20	126
Cos Filter 2 10-21	126
Cos Filter 3 10-22	126
Cos Filter 4 10-23	127
Cost Savings 23-84	225
Counter A 16-72	164
Counter B 16-73	164
Current Lim Ctrl, Integration Time 14-31	149
Current Lim Ctrl, Proportional Gain 14-30	149
Current Limit 4-18	62
Current Limit Control, 14-3*	149
Custom Readout 16-09	160
Custom Readout Max Value 0-32	34
Custom Readout Min Value 0-31	34
Custom Readout Unit 0-30	33

D

Data Log Settings, 15-1*	153
Date And Time 0-70	37
Date And Time Readout 0-89	39
Date Format 0-71	37
Dc Brake Current 2-01	50
[Dc Brake Cut In Speed Rpm] 2-03	50
Dc Brake Select 8-52	110
Dc Braking Time 2-02	50
Dc Hold/preheat Current 2-00	50
Dc Link	261
Dc Link Voltage 16-30	161
Default Settings	265
Default Settings	22
Defined Parameters 15-92	159
Defined Parameters (1) 9-80	120
Defined Parameters (2) 9-81	121
Defined Parameters (3) 9-82	121
Defined Parameters (4) 9-83	121
Destage At No-flow 25-26	237
Destage Function 25-29	237
Destage Function Time 25-30	238
[Destaging Speed Hz] 25-47	241
[Destaging Speed Rpm] 25-46	240
Destaging Threshold 25-43	239
Devicenet	123
Devicenet And Can Fieldbus	122
Devicenet F Parameters 10-39	127
Devicenet Revision 10-32	127
Diagnosis Trigger 8-07	107
Digi Pot Reference 16-53	162
Digital & Relay Bus Control 5-90	94
Digital I/o Mode 5-00	65
Digital Input 16-60	163
Digital Inputs, 5-1* Continued	66

[Digital Output Bin] 16-66	163
Display Line 1.1 Small 0-20	28
Display Line 1.2 Small, 0-21	31
Display Line 1.3 Small, 0-22	31
Display Line 2 Large, 0-23	31
Display Line 3 Large, 0-24	32
Display Text 1 0-37	34
Display Text 2 0-38	34
Display Text 3 0-39	35
Drive Bypass Delay Time 24-11	232
Drive Bypass Function 24-10	231
Drive Identification, 15-4*	157
Drive Information	152
Drive Profile 11-10	128
Dry Pump Delay 22-27	198
Dry Pump Function 22-26	198
Dst/summertime 0-74	38
Dst/summertime End 0-77	38
Dst/summertime Start 0-76	38

E

End Of Curve Delay 22-51	204
End Of Curve Function 22-50	204
End Of Curve, 22-5*	204
End-of-timeout Function 8-05	106
Energy Cost 23-81	225
Energy Log 23-53	219
Energy Log Resolution 23-50	218
Energy Log, 23-5*	217
Energy Optimising, 14-4*	149
Energy Savings 23-83	225
Environment, 14-5*	150
Etr	261
Example Of Changing Parameter Data	13
Ext. 1 Dif. Gain Limit 21-24	189
Ext. 1 Differentiation Time 21-23	188
Ext. 1 Feedback Source 21-14	187
[Ext. 1 Feedback Unit] 21-18	188
Ext. 1 Integral Time 21-22	188
Ext. 1 Maximum Reference 21-12	186
Ext. 1 Minimum Reference 21-11	186
Ext. 1 Normal/inverse Control 21-20	188
[Ext. 1 Output %] 21-19	188
Ext. 1 Proportional Gain 21-21	188
Ext. 1 Ref./feedback Unit 21-10	185
Ext. 1 Reference Source 21-13	187
[Ext. 1 Reference Unit] 21-17	187
Ext. 1 Setpoint 21-15	187
Ext. 2 Dif. Gain Limit 21-44	192
Ext. 2 Differentiation Time 21-43	192
Ext. 2 Feedback Source 21-34	191
[Ext. 2 Feedback Unit] 21-38	191
Ext. 2 Integral Time 21-42	192
Ext. 2 Maximum Reference 21-32	190
Ext. 2 Minimum Reference 21-31	190
Ext. 2 Normal/inverse Control 21-40	191
[Ext. 2 Output %] 21-39	191
Ext. 2 Proportional Gain 21-41	191
Ext. 2 Ref./feedback Unit 21-30	189
Ext. 2 Reference Source 21-33	190
[Ext. 2 Reference Unit] 21-37	191
Ext. 2 Setpoint 21-35	191
Ext. 3 Dif. Gain Limit 21-64	195
Ext. 3 Differentiation Time 21-63	195
Ext. 3 Feedback Source 21-54	194
[Ext. 3 Feedback Unit] 21-58	194
Ext. 3 Integral Time 21-62	195

Ext. 3 Maximum Reference 21-52	193
Ext. 3 Minimum Reference 21-51	193
Ext. 3 Normal/inverse Control 21-60	194
[Ext. 3 Output %] 21-59	194
Ext. 3 Proportional Gain 21-61	194
Ext. 3 Ref./feedback Unit 21-50	192
Ext. 3 Reference Source 21-53	193
[Ext. 3 Reference Unit] 21-57	194
Ext. 3 Setpoint 21-55	194
Ext. Status Word 16-94	165
Ext. Status Word 2 16-95	165
Extended Status Word	260
Extended Status Word 2	260
External Interlock Delay 22-00	195
External Reference 16-50	162
F	
Fan Control 14-52	150
Fan Monitor 14-53	150
Fault Messages	261
Fc Port Ctw 1 16-85	164
Fc Port Ref 1 16-86	165
Fc Type 15-40	157
Feedback 1 Conversion 20-01	169
Feedback 1 Source 20-00	168
Feedback 1 Source Unit 20-02	169
[Feedback 1 Unit] 16-54	162
Feedback 2 Conversion 20-04	171
Feedback 2 Source 20-03	170
Feedback 2 Source Unit 20-05	171
[Feedback 2 Unit] 16-55	162
Feedback 3 Conversion 20-07	172
Feedback 3 Source 20-06	172
Feedback 3 Source Unit 20-08	172
[Feedback 3 Unit] 16-56	162
Feedback Function 20-20	175
[Feedback Unit] 16-52	162
Fieldbus Ctw 1 16-80	164
Fieldbus Ref 1 16-82	164
Fire Mode Alarm Handling 24-09	229
Fire Mode Configuration 24-01	227
Fire Mode Feedback Source 24-07	229
Fire Mode Function 24-00	226
Fire Mode Live Zero Timeout Function 6-02	97
Fire Mode Log: Date And Time 18-12	167
Fire Mode Log: Event 18-10	166
Fire Mode Log: Time 18-11	166
Fire Mode Max Reference 24-04	228
Fire Mode Min Reference 24-03	228
Fire Mode Preset Reference 24-05	228
Fire Mode Reference Source 24-06	229
Fire Mode Unit 24-02	227
Fixed Lead Pump 25-05	234
Fixed Speed Bandwidth 25-22	235
Flow At Design Point 22-89	209
Flow At Rated Speed 22-90	209
Flow Compensation 22-80	207
Flying Start 1-73	46
Frequency 16-13	160
[Frequency %] 16-15	160
Frequency Converter Ordering No 15-46	158
Frequency Converter Serial Number 15-51	158
Function At Inverter Overload 14-61	152
Function At Mains Imbalance 14-12	146
Function At Over Temperature 14-60	151
Function At Stop 1-80	46
Function Relay 5-40	88

Function Setups	16
G	
General Settings, 1-0*	39
Graphical Display	5
H	
[Hand On] Key On Lcp 0-40	35
Heatsink Temp. 16-34	161
[High Speed Hz] 22-37	199
High Speed Load Compensation 1-61	45
[High Speed Power Hp] 22-39	200
[High Speed Power Kw] 22-38	200
[High Speed Rpm] 22-36	199
Historic Log,15-2*	156
Historic Log: Event 15-20	156
Historic Log: Time 15-22	157
Historic Log: Value 15-21	156
How To Operate Graphical Lcp (glcp)	5
I	
Indicator Lights	7
Initialisation	22
Initialisation Password 8-75	112
Intermediate Circuit	261
Interval Between Starts 22-76	205
Inv. Max. Current 16-37	161
Inv. Nom. Current 16-36	161
Inv. Overload Derate Current 14-62	152
Inverter Thermal 16-35	161
Investment 23-82	225
Iron Loss Resistance (rfe) 1-36	44
J	
Jog Ramp Time 3-80	58
[Jog Speed Hz] 3-11	54
[Jog Speed Rpm] 3-19	56
K	
Keypad, 0-4*	35
Kty Sensor	261
Kwh Counter 15-02	152
L	
Language 0-01	24
Language Package 1	24
Language Package 2	24
Lcp 102	5
Lcp Copy 0-50	36
Lcp Id No 15-48	158
Lead Pump 25-82	244
Lead Pump Alternation 25-50	241
Leds	5
Live Zero Timeout Function 6-01	96
Live Zero Timeout Time 6-00	96
Local Mode Unit 0-05	25
Local Reference	25
Logging Buffer Full 16-40	162
Logging Interval 15-11	155
Logging Mode 15-13	156
Logging Source 15-10	154
Loggings	14
Logic Rule Boolean 1 13-40	135
Logic Rule Boolean 2 13-42	137

Logic Rule Boolean 3 13-44	139
Logic Rule Operator 1 13-41	137
Logic Rule Operator 2 13-43	139
Lon Warning Word 11-15	128
Lonworks Revision 11-18	128
Lonworks, 11*	127
Low Power Auto Set-up 22-20	197
Low Power Detection 22-21	197
Low Speed Detection 22-22	197
[Low Speed Hz] 22-33	199
Low Speed Load Compensation 1-60	45
[Low Speed Power Hp] 22-35	199
[Low Speed Power Kw] 22-34	199
[Low Speed Rpm] 22-32	199

M

Mac Id 10-02	122
[Main Actual Value %] 16-05	160
Main Menu - Frequency Converter Information - Group 15	152
Main Menu Mode	8, 13
Main Menu Mode	19
Main Menu Password 0-60	36
Main Menu Structure	23
Main Reactance	42
Main Reactance (xh) 1-35	43
Mains Failure 14-10	145
Mains On/off, 14-1*	144
Mains Voltage At Mains Fault 14-11	146
Maintenance Action 23-11	215
Maintenance Date And Time 23-14	216
Maintenance Item 23-10	214
Maintenance Log: Action 18-01	166
Maintenance Log: Date And Time 18-03	166
Maintenance Log: Item 18-00	165
Maintenance Log: Time 18-02	166
Maintenance Text, 23-16	216
Maintenance Time Base 23-12	215
Maintenance Time Interval 23-13	215
Maintenance Word 16-96	165
Manual Alternation 25-91	245
Manual Initialisation	22
Max Output Frequency 4-19	62
Maximum Boost Time 22-46	204
Maximum Feedback Level 20-74	180, 184
Maximum Inter-char Delay 8-37	109
Maximum Limit 3-93	59
Maximum Reference 3-03	53
Maximum Reference/feedb. 20-14	175
Maximum Response Delay 8-36	109
[Min Speed For Function At Stop Hz] 1-82	47
[Min Speed For Function At Stop Rpm] 1-81	47
[Min Speed Normal Magnetising Hz] 1-52	45
[Min Speed Normal Magnetising Rpm] 1-51	44
Minimum Ae0 Frequency 14-42	150
Minimum Bin Value 23-65	223
Minimum Feedback Level 20-73	180, 184
Minimum Limit 3-94	59
Minimum Reference 3-02	53
Minimum Reference/feedb. 20-13	175
Minimum Response Delay 8-35	109
Minimum Run Time 22-40	203, 205
Minimum Sleep Time 22-41	203
Missing Motor Phase Function 4-58	64
Modified Parameters 15-93	159
Motor Cosphi 14-43	150
Motor Current 1-24	41, 160
Motor External Fan 1-91	49

Motor Frequency 1-23	41
Motor Magnetisation At Zero Speed 1-50	44
Motor Nominal Speed 1-25	41
Motor Poles 1-39	44
[Motor Power Hp] 1-21	41
[Motor Power Kw] 1-20	40
Motor Protection	48
Motor Rotation Check 1-28	42
Motor Speed Direction 4-10	60
[Motor Speed High Limit Hz] 4-14	61
[Motor Speed High Limit Rpm] 4-13	61
[Motor Speed Low Limit Hz] 4-12	60
[Motor Speed Low Limit Rpm] 4-11	60
Motor Speed Unit 0-02	25
Motor Start 25-02	233
Motor Status	160
Motor Thermal 16-18	161
Motor Thermal Protection 1-90	48
Motor Voltage 1-22	41, 160
Ms/tp Max Info Frames 8-73	112
Ms/tp Max Masters 8-72	111
My Personal Menu	14, 32

N

Net Control 10-15	126
Net Reference 10-14	126
Neuron Id 11-00	127
Nlcp	10
No Operation	15
No Trip At Inverter Overload	151
Node Address 9-18	116
No-flow Delay 22-24	198
No-flow Function 22-23	198
No-flow Power 22-30	199
Number Of Pumps 25-06	234
Number Of Starts 15-08	153

O

Obw Time 25-25	236
Occurrence 23-04	213
Off Action 23-03	212
Off Delay, Relay 5-42	90
Off Time 23-02	212
[Off] Key On Lcp 0-41	35
On Action 23-01	210
On Delay, Relay 5-41	89
On Reference Bandwidth 20-84	182
On Time 23-00	210
Operating Hours 15-00	152
Operating Mode	25
Operating State At Power-up 0-04	25
Operation Mode 14-22	148
Option Ident. 15-6*	158
Option Mounted 15-60	159
Option Ordering No 15-62	159
Option Serial No 15-63	159
Option Sw Version 15-61	159
Ordered Typecode String 15-44	158
Over Temp's 15-04	152
Over Volt's 15-05	152
Overmodulation 14-03	144
Override Bandwidth 25-21	234
Over-voltage Control 2-17	52

P

Parameter Access	127
------------------	-----

Parameter Data	13
Parameter Edit 9-27	118
Parameter Info, 15-9*	159
Parameter Metadata 15-99	159
Parameter Options	265
Parameter Selection	20
Parameter Set-up	13
Parameters For Signals 9-23	116
Parity / Stop Bits 8-33	109
Pcd Read Configuration 9-16	114
Pcd Write Configuration 9-15	114
Period Start 23-51	218
Personal Menu Password 0-65	37
Pid Anti Windup 20-91	182
Pid Autotuning 20-79	181, 185
Pid Diff. Gain Limit 20-96	183
Pid Differentiation Time 20-95	183
Pid Integral Time 20-94	182
Pid Normal/ Inverse Control 20-81	181
[Pid Output %] 16-58	162
Pid Output Change 20-72	180, 184
Pid Performance 20-71	180, 184
Pid Proportional Gain 20-93	182
[Pid Start Speed Hz] 20-83	181
[Pid Start Speed Rpm] 20-82	181
Power Card Ordering No 15-47	158
Power Card Serial Number 15-53	158
Power Correction Factor 22-31	199
[Power Hp] 16-11	160
[Power Kw] 16-10	160
Power Reference Factor 23-80	224
Power Restore 3-92	59
Power Section 15-41	157
Power Up's 15-03	152
Preset Reference 3-10	53
Preset Reference Select 8-56	111
Preset Relative Reference 3-14	54
Pressure At No-flow Speed 22-87	209
Pressure At Rated Speed 22-88	209
Process Control 9-28	119
Process Data Config Read 10-12	124
Process Data Config Write 10-11	123
Process Data Type Selection 10-10	123
Profibus Save Data Values 9-71	120
Profibus Warning Word 9-53	119
Profibusdrivereset 9-72	120
Profile Number 9-65	120
Programming Set-up 0-11	26, 120
Protocol 8-30	108
Pulse Filter Time Constant #29 5-54	91
Pulse Filter Time Constant #33 5-59	91
[Pulse Input #29 Hz] 16-67	163
[Pulse Input #33 Hz] 16-68	163
Pulse Out #27 Bus Control 5-93	95
Pulse Out #27 Timeout Preset 5-94	95
Pulse Out #29 Bus Control 5-95	95
Pulse Out #29 Timeout Preset 5-96	95
Pulse Out #x30/6 Bus Control 5-97	95
Pulse Out #x30/6 Timeout Preset 5-98	95
[Pulse Output #27 Hz] 16-69	164
[Pulse Output #29 Hz] 16-70	164
Pulse Output Max Freq #27 5-62	93
Pulse Output Max Freq #29 5-65	93
Pulse Output Max Freq #x30/6 5-68	94
Pump Cycling 25-04	234
Pump Interlock 25-90	245
Pump On Time 25-84	244
Pump Status 25-81	244

Pwm Random 14-04	144
------------------	-----

Q

Quick Menu	8
Quick Menu Mode	8, 13
Quick Menu Mode	13
Quick Transfer Of Parameter Settings Between Multiple Frequency Converters	12

R

Ramp 1 Ramp Down Time 3-42	57
Ramp 1 Ramp Up Time 3-41	57
Ramp 2 Ramp Down Time 3-52	58
Ramp 2 Ramp Up Time 3-51	57
Ramp Delay 3-95	59
Ramp Down Delay 25-40	238
Ramp Time 3-91	59
Ramp Up Delay 25-41	238
Read-out And Programming Of Indexed Parameters	21
Readout Bus Off Counter 10-07	123
Readout Receive Error Counter 10-06	123
Readout Transmit Error Counter 10-05	122
Readout: Linked Set-ups 0-13	28
Readout: Prog. Set-ups / Channel 0-14	28
[Reference %] 16-02	160
Reference 1 Source 3-15	55
Reference 2 Source 3-16	56
Reference 3 Source 3-17	56
Reference Function 3-04	53
Reference Site 3-13	54
[Reference Unit] 16-01	160
Reference/feedback Unit 20-12	173
Refrigerant 20-30	179
Regional Settings 0-03	25
Relay On Time 25-85	245
[Relay Output Bin] 16-71	164
Relay Outputs	78
Relay Status 25-83	244
Reset Continuous Bin Data 23-66	223
Reset Control Timeout 8-06	107
Reset Energy Log 23-54	219
Reset Kwh Counter 15-06	153
Reset Maintenance Word 23-15	216
Reset Mode 14-20	147
Reset Relay Counters 25-86	245
Reset Running Hours Counter 15-07	153
Reset Slc 13-03	132
Reset Timed Bin Data 23-67	223
[Reset] Key On Lcp 0-43	35
Resonance Dampening 1-64	46
Resonance Dampening Time Constant 1-65	46
Reversing Select 8-54	110
Rfi Filter 14-50	150
Run Next Pump Delay 25-58	244
Run On Mains Delay 25-59	244
Running Hours 15-01	152

S

Samples Before Trigger 15-14	156
Sbw Destaging Delay 25-24	236
Sbw Staging Delay 25-23	236
Semi-auto Bypass Set-up 4-64	65
Service Code 14-29	149
Setpoint 1 20-21	178
Setpoint 2 20-22	178
Setpoint 3 20-23	178
Setpoint Boost 22-45	203

Set-up Copy 0-51	36
Set-up Select 8-55	111
Short Cycle Protection	205
SI Controller Action 13-52	142
SI Controller Event 13-51	140
SI Controller Mode 13-00	129
SI Controller State 16-38	161
SI Controller Timer 13-20	134
Slave Error Count 8-83	113
Slave Messages Rcvd 8-82	112
Sleep Mode	200
Slip Compensation 1-62	45
Slip Compensation Time Constant 1-63	46
Software Version	3, 158
Special Functions	143
[Speed At Design Point Hz] 22-86	209
[Speed At Design Point Rpm] 22-85	209
[Speed At No-flow Hz] 22-84	209
[Speed At No-flow Rpm] 22-83	209
[Speed Rpm] 16-17	161
Square-linear Curve Approximation 22-81	207
Stage Function 25-27	237
Stage Function Time 25-28	237
Staging Bandwidth 25-20	234
Staging Mode At Alternation 25-56	243
[Staging Speed Hz] 25-45	240
[Staging Speed Rpm] 25-44	240
Staging Threshold 25-42	239
Start Delay 1-71	46
Start Event 13-01	129
Start Select 8-53	110
Stator Leakage Reactance	42
Stator Resistance (rs) 1-30	43
Status	8
Status Messages	5, 255
Status Word 16-03	160
Step Size 3-90	58
Step-by-step	21
Stop Event 13-02	131
Store Always 10-33	127
Store Data Values 10-31	127, 128
Sw Id Control Card 15-49	158
Sw Id Power Card 15-50	158
Switching Frequency 14-01	144
Switching Pattern 14-00	144

T

Telegram Selection 8-40	109, 116
Term X30/6 Digi Out (mcb 101) 5-32	84
Term X30/7 Digi Out (mcb 101) 5-33	86
Term. 29 High Frequency 5-51	91
Term. 29 High Ref./feedb. Value 5-53	91
Term. 29 Low Frequency 5-50	91
Term. 29 Low Ref./feedb. Value 5-52	91
Term. 33 High Frequency 5-56	91
Term. 33 High Ref./feedb. Value 5-58	91
Term. 33 Low Frequency 5-55	91
Term. 33 Low Ref./feedb. Value 5-57	91
Term. X30/11 Filter Time Constant 6-36	99
Term. X30/11 High Ref./feedb. Value 6-35	99
Term. X30/11 Live Zero 6-37	99
Term. X30/11 Low Ref./feedb. Value 6-34	99
Term. X30/12 Filter Time Constant 6-46	100
Term. X30/12 High Ref./feedb. Value 6-45	100
Term. X30/12 Live Zero 6-47	100
Term. X30/12 Low Ref./feedb. Value 6-44	100
Term. X42/1 Filter Time Constant 26-16	249

Term. X42/1 High Ref./feedb. Value 26-15	249
Term. X42/1 Live Zero 26-17	249
Term. X42/1 Low Ref./feedb. Value 26-14	249
Term. X42/3 Filter Time Constant 26-26	250
Term. X42/3 High Ref./feedb. Value 26-25	249
Term. X42/3 Live Zero 26-27	250
Term. X42/3 Low Ref./feedb. Value 26-24	249
Term. X42/5 Filter Time Constant 26-36	250
Term. X42/5 High Ref./feedb. Value 26-35	250
Term. X42/5 Live Zero 26-37	250
Term. X42/5 Low Ref./feedb. Value 26-34	250
Terminal 18 Digital Input 5-10	69
Terminal 19 Digital Input 5-11	70
Terminal 27 Digital Input 5-12	71
Terminal 27 Digital Output 5-30	81
Terminal 27 Mode 5-01	65
Terminal 27 Pulse Output Variable 5-60	93
Terminal 29 Digital Input 5-13	72
Terminal 29 Digital Output 5-31	83
Terminal 29 Mode 5-02	66
Terminal 29 Pulse Output Variable 5-63	93
Terminal 32 Digital Input 5-14	73
Terminal 33 Digital Input 5-15	74
Terminal 42 Output 6-50	100
Terminal 42 Output Bus Control 6-53	103
Terminal 42 Output Max Scale 6-52	102
Terminal 42 Output Min Scale 6-51	101
Terminal 42 Output Timeout Preset 6-54	103
Terminal 53 Filter Time Constant 6-16	98
Terminal 53 High Current 6-13	97
Terminal 53 High Ref./feedb. Value 6-15	97
Terminal 53 High Voltage 6-11	97
Terminal 53 Live Zero 6-17	98
Terminal 53 Low Current 6-12	97
Terminal 53 Low Ref./feedb. Value 6-14	97
Terminal 53 Low Voltage 6-10	97
Terminal 53 Switch Setting 16-61	163
Terminal 54 Filter Time Constant 6-26	99
Terminal 54 High Current 6-23	98
Terminal 54 High Ref./feedb. Value 6-25	98
Terminal 54 High Voltage 6-21	98
Terminal 54 Live Zero 6-27	99
Terminal 54 Low Current 6-22	98
Terminal 54 Low Ref./feedb. Value 6-24	98
Terminal 54 Low Voltage 6-20	98
Terminal 54 Switch Setting 16-63	163
Terminal X30/11 High Voltage 6-31	99
Terminal X30/11 Low Voltage 6-30	99
Terminal X30/12 High Voltage 6-41	100
Terminal X30/12 Low Voltage 6-40	100
Terminal X30/2 Digital Input 5-16	75
Terminal X30/3 Digital Input 5-17	76
Terminal X30/4 Digital Input 5-18	77
Terminal X30/6 Pulse Output Variable 5-66	94
Terminal X30/8 Max. Scale 6-62	104
Terminal X30/8 Min. Scale 6-61	104
Terminal X30/8 Output 6-60	104
Terminal X30/8 Output Bus Control 6-63	105
Terminal X30/8 Output Timeout Preset 6-64	105
Terminal X42/1 High Voltage 26-11	249
Terminal X42/1 Low Voltage 26-10	248
Terminal X42/1 Mode 26-00	248
Terminal X42/11 Bus Control 26-63	253
Terminal X42/11 Max. Scale 26-62	253
Terminal X42/11 Min. Scale 26-61	253
Terminal X42/11 Output 26-60	252
Terminal X42/11 Timeout Preset 26-64	253
Terminal X42/3 High Voltage 26-21	249

Terminal X42/3 Low Voltage 26-20	249
Terminal X42/3 Mode 26-01	248
Terminal X42/5 High Voltage 26-31	250
Terminal X42/5 Low Voltage 26-30	250
Terminal X42/5 Mode 26-02	248
Terminal X42/7 Bus Control 26-43	251
Terminal X42/7 Max. Scale 26-42	251
Terminal X42/7 Min. Scale 26-41	251
Terminal X42/7 Output 26-40	250
Terminal X42/7 Timeout Preset 26-44	251
Terminal X42/9 Bus Control 26-53	252
Terminal X42/9 Max. Scale 26-52	252
Terminal X42/9 Min. Scale 26-51	252
Terminal X42/9 Output 26-50	251
Terminal X42/9 Timeout Preset 26-54	252
Thermal Load	44
Thermistor	48
Thermistor Source 1-93	49
This Set-up Linked To 0-12	27
Time Format 0-72	38
Timed Actions, 23-0*	210
Timed Bin Data 23-62	222
Timed Period Start 23-63	223
Timed Period Stop 23-64	223
[Torque %] 16-22	161
Torque Characteristics 1-03	40
Torque Limit Generator Mode 4-17	61
Torque Limit Motor Mode 4-16	61
[Torque Nm] 16-16	161
Trend Variable 23-60	222
Trending, 23-6*	220
Trigger Event 15-12	155
Trip At Motor Speed Low Limit	47
Trip Delay At Inverter Fault 14-26	149
Trip Delay At Torque Limit 14-25	149
Trip Reset, 14-2*	146
[Trip Speed Low Hz] 1-87	47
[Trip Speed Low Rpm] 1-86	47
Troubleshooting	255

U

User Defined Refrigerant A1 20-31	179
User Defined Refrigerant A2 20-32	179
User Defined Refrigerant A3 20-33	179

V

Voltage 15-42	158
Vt Level 14-40	149

W

Wake-up Ref./fb Difference 22-44	203
[Wake-up Speed Hz] 22-43	203
[Wake-up Speed Rpm] 22-42	203
Warning Current High 4-51	63
Warning Current Low 4-50	62
Warning Feedback High 4-57	63
Warning Feedback Low 4-56	63
Warning Parameter 10-13	125
Warning Reference High 4-55	63
Warning Reference Low 4-54	63
Warning Speed High 4-53	63
Warning Speed Low 4-52	63
Warning Word	259
Warning Word 16-92	165
Warning Word 2	259
Warning Word 2 16-93	165

Work Point Calculation 22-82	208
Working Days 0-81	38
X	
Xif Revision 11-17	128